



US00D520155S

(12) **United States Design Patent**
Okuda

(10) **Patent No.:** **US D520,155 S**

(45) **Date of Patent:** **** May 2, 2006**

(54) **HEADLAMP FOR A BICYCLE**
(75) Inventor: **Yoji Okuda**, Tondabayashi (JP)
(73) Assignee: **Cateye Co., Ltd.**, Osaka (JP)
(**) Term: **14 Years**

D441,107 S * 4/2001 Okuda D26/28
D441,471 S * 5/2001 Nagano D26/28
D444,581 S * 7/2001 Okuda D26/28
D498,550 S * 11/2004 Chen D26/28

* cited by examiner

Primary Examiner—Marcus A. Jackson
(74) *Attorney, Agent, or Firm*—Olson & Hierl, Ltd.

(21) Appl. No.: **29/223,584**
(22) Filed: **Feb. 16, 2005**

(57) **CLAIM**

The ornamental design for a headlamp for a bicycle, as shown.

(30) **Foreign Application Priority Data**
Sep. 17, 2004 (JP) 2004-028347

DESCRIPTION

(51) **LOC (8) Cl.** **26-06**
(52) **U.S. Cl.** **D26/28**
(58) **Field of Classification Search** D26/28-36;
362/459-468, 475-478, 485-487
See application file for complete search history.

FIG. 1 is a perspective view of a headlamp for a bicycle showing my new design;
FIG. 2 is a front view thereof;
FIG. 3 is a rear view thereof;
FIG. 4 is a top plan view thereof;
FIG. 5 is a bottom plan view thereof;
FIG. 6 is a right side view thereof; and,
FIG. 7 is a left side view thereof.

(56) **References Cited**
U.S. PATENT DOCUMENTS
D440,675 S * 4/2001 Okuda D26/28

1 Claim, 4 Drawing Sheets

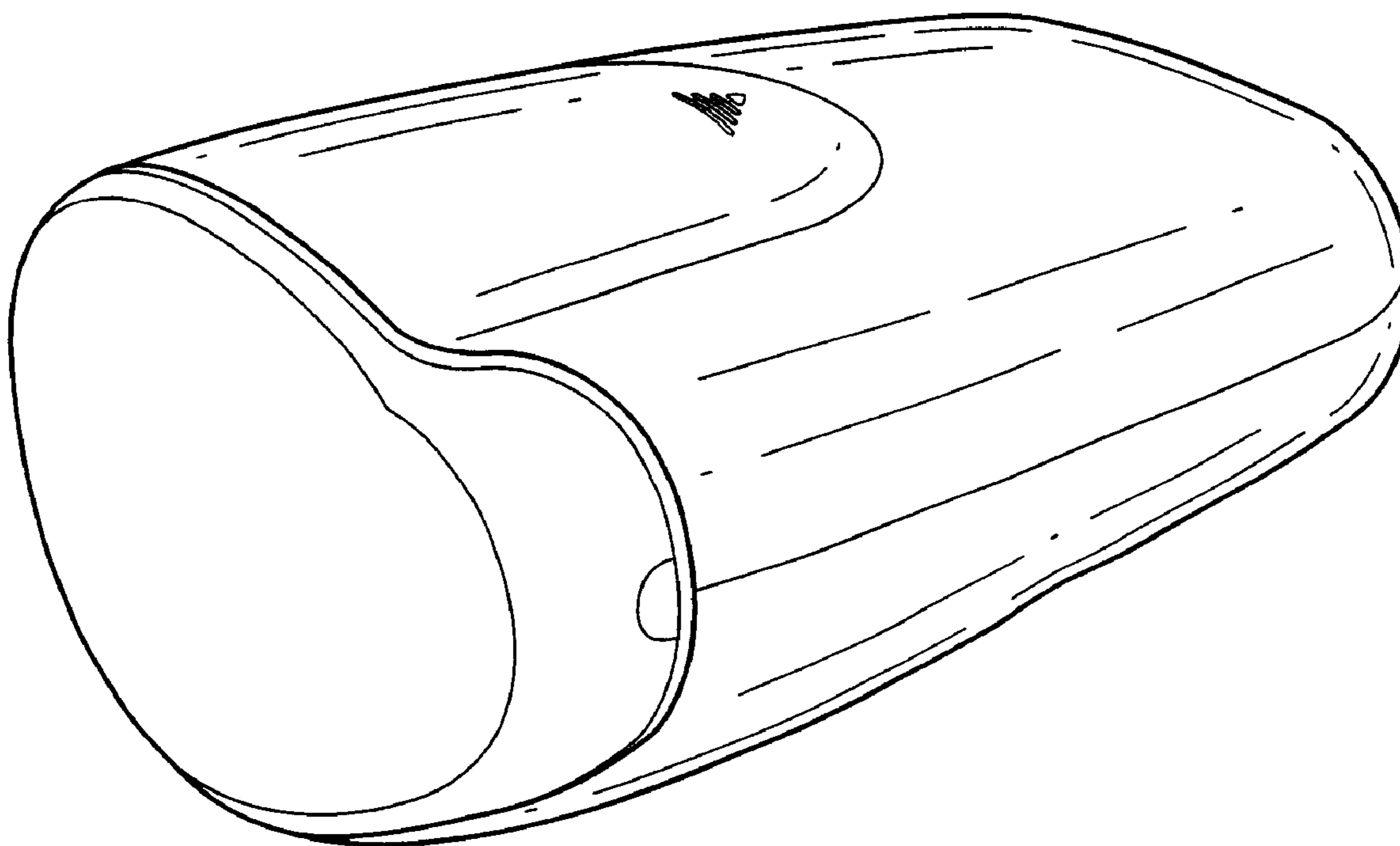

FIG. 1

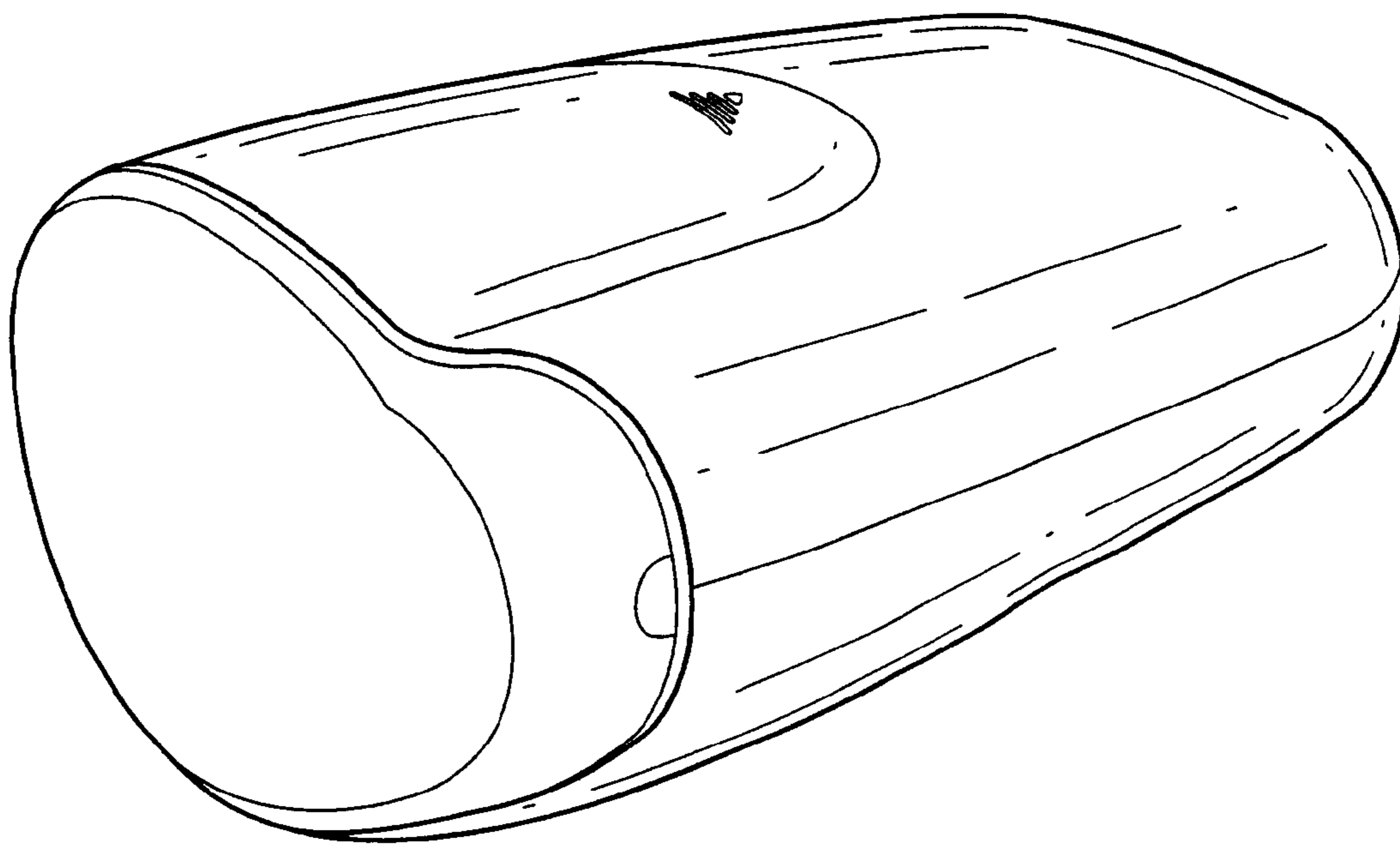

FIG. 2

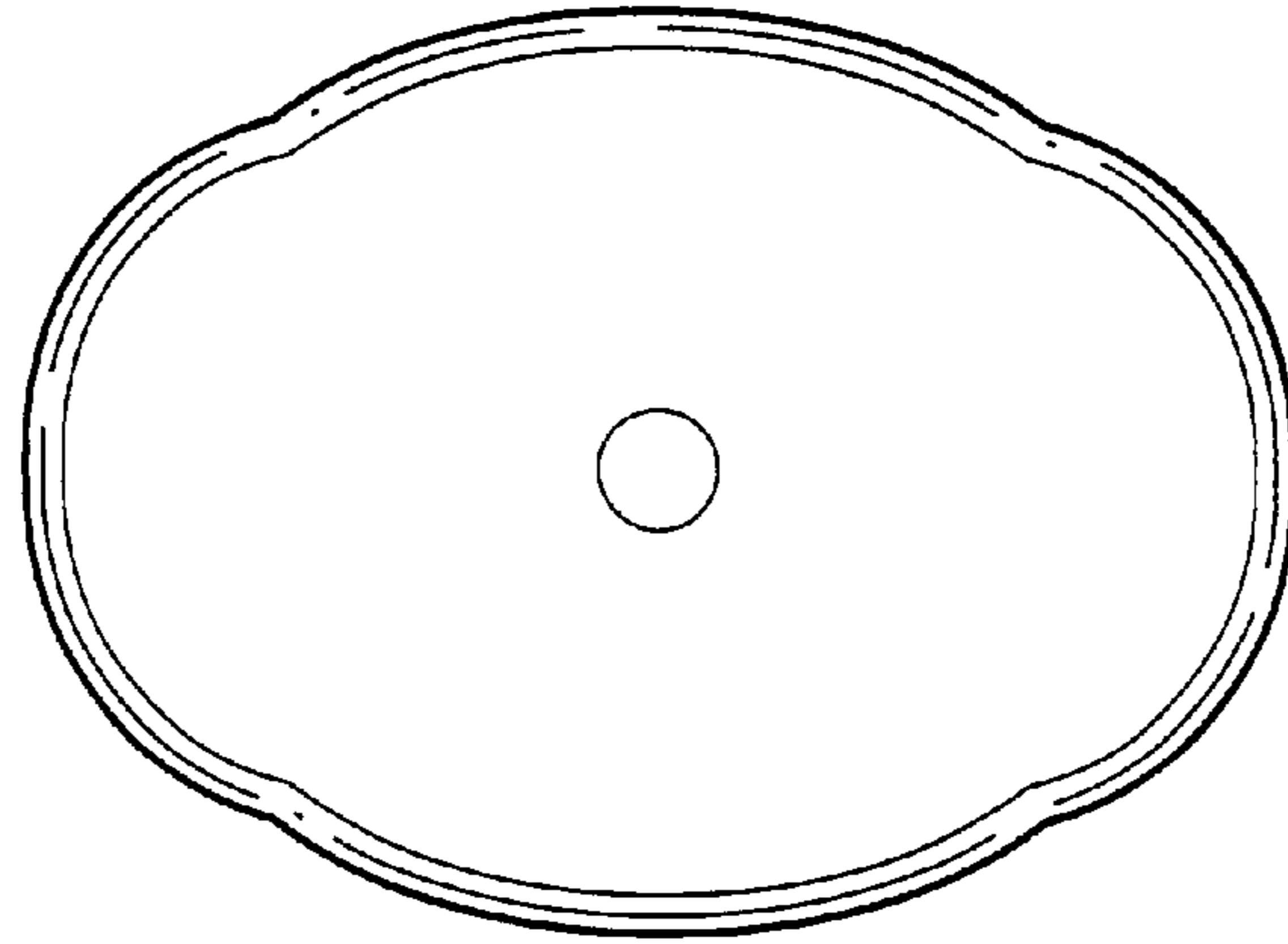

FIG. 3

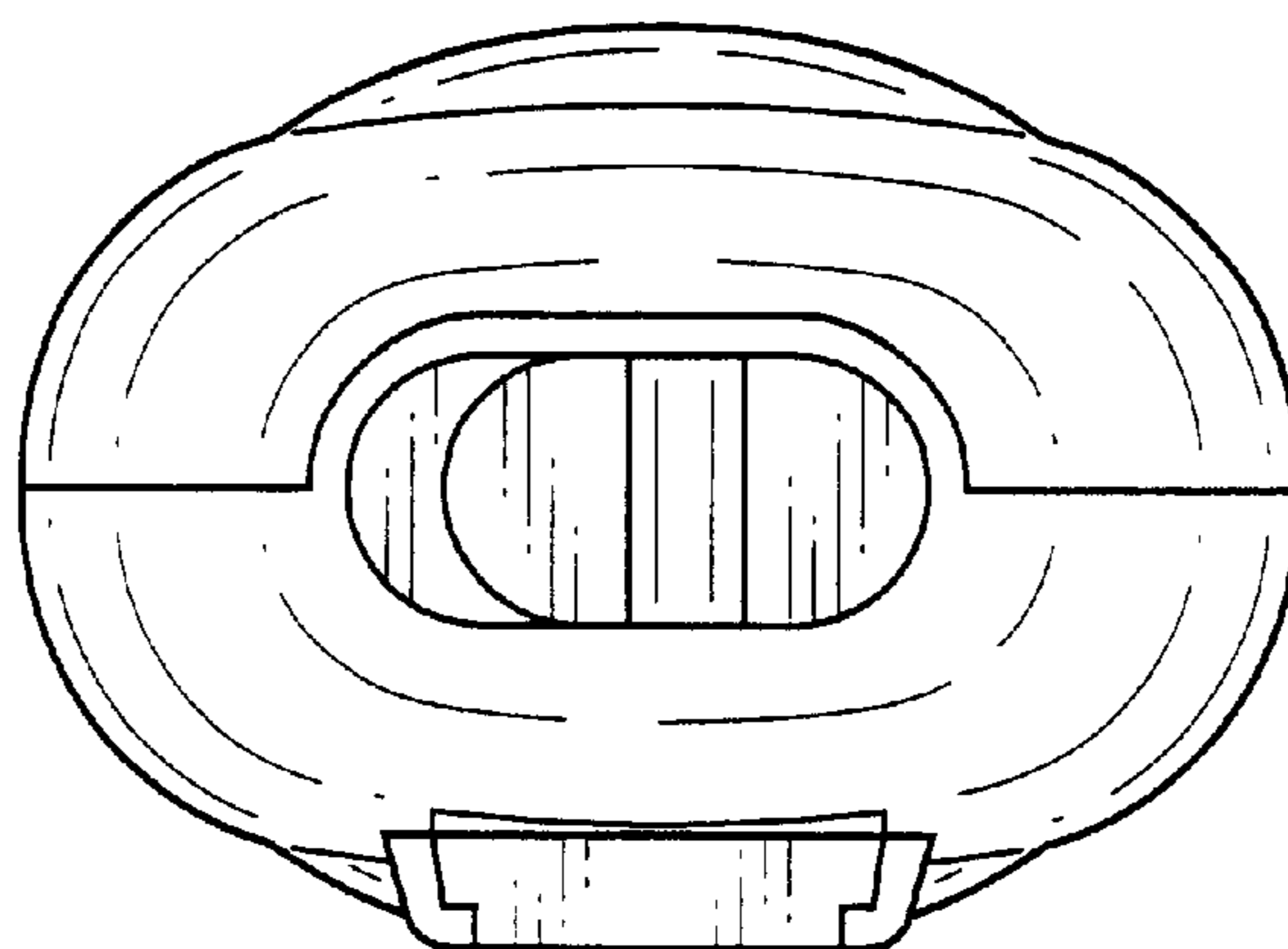

FIG. 4

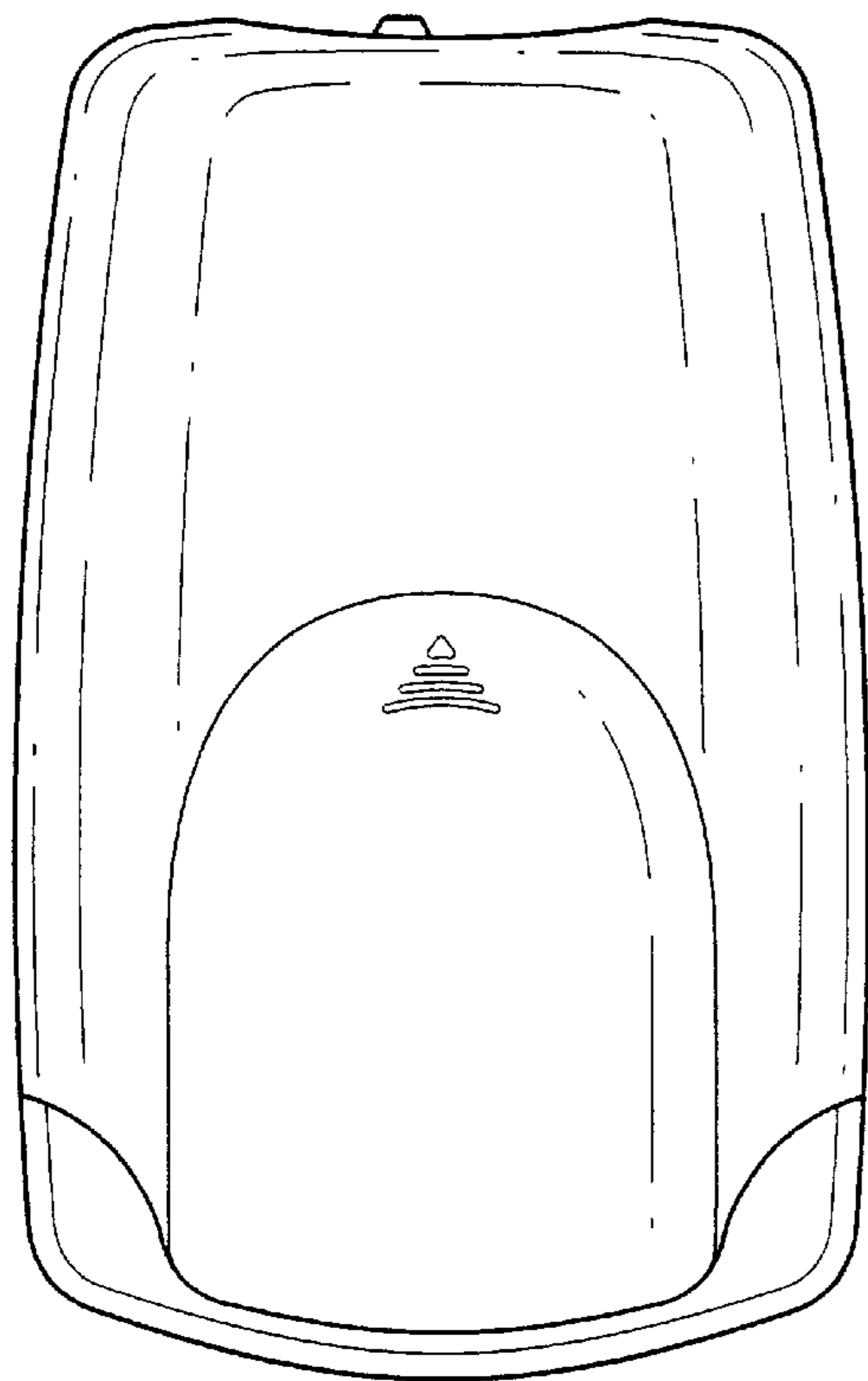

FIG. 5

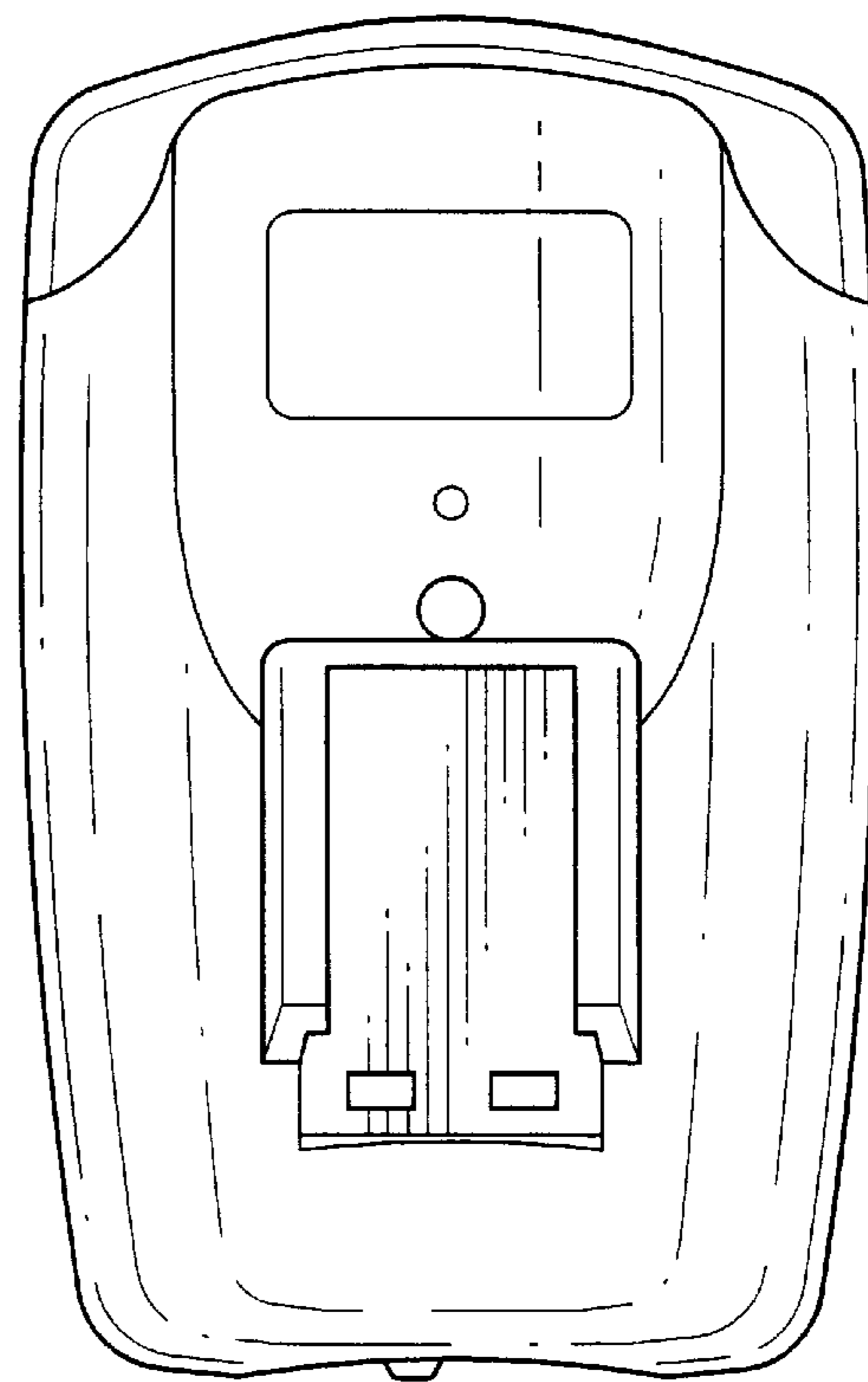

FIG. 6

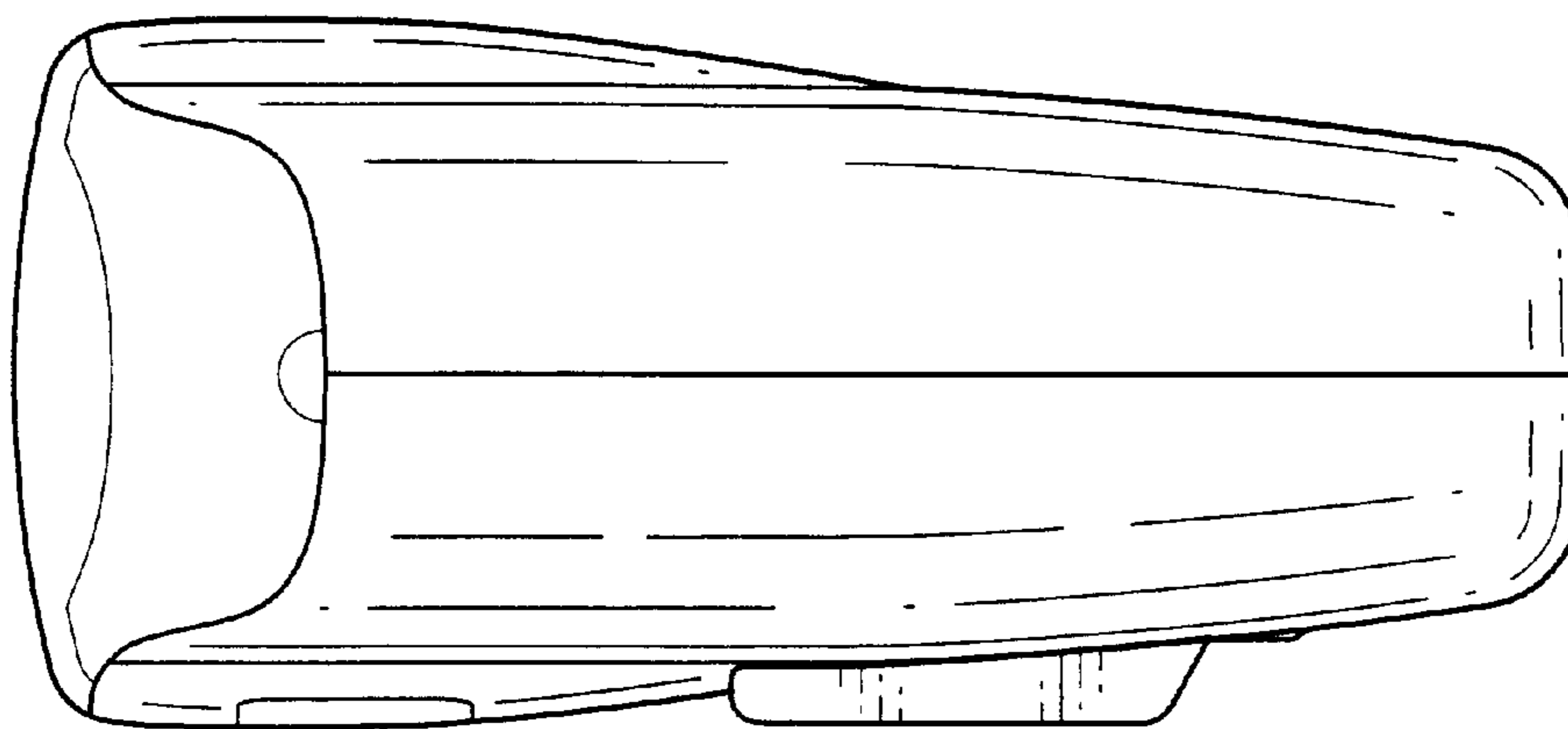

FIG. 7

