



US00D520144S

(12) **United States Design Patent**
Cafaro et al.

(10) **Patent No.:** **US D520,144 S**

(45) **Date of Patent:** **** May 2, 2006**

(54) **BODY MASSAGER**

(75) Inventors: **Michael Cafaro**, El Paso, TX (US);
Jack Zou, Xiamen (CN)

(73) Assignee: **Helen of Troy Limited**, Bridgetown (BB)

(**) Term: **14 Years**

(21) Appl. No.: **29/192,580**

(22) Filed: **Oct. 27, 2003**

(51) **LOC (8) Cl.** **28-03**

(52) **U.S. Cl.** **D24/215; D24/211**

(58) **Field of Classification Search** D24/211,
D24/200, 212, 215, 214, 213; 601/69, 111,
601/46, 50, 70, 72, 73, 80, 94, 97, 113, 101,
601/135, 122, 22, 15, 134, 27, 28, 30, 31,
601/32, 81

See application file for complete search history.

(56) **References Cited**

U.S. PATENT DOCUMENTS

3,494,353 A 2/1970 Marich
D351,027 S * 9/1994 Chen D24/213
D371,850 S * 7/1996 Ediger et al. D24/213

5,827,205 A * 10/1998 Iwamoto 601/28
D403,429 S 12/1998 Blanchard
D405,886 S 2/1999 Haynes
D408,924 S 4/1999 Chen
D411,304 S 6/1999 Yang
D455,837 S 4/2002 Kim
D473,316 S 4/2003 Chou

* cited by examiner

Primary Examiner—Ian Simmons

(74) *Attorney, Agent, or Firm*—Vision & Elkins L.L.P.

(57) **CLAIM**

The ornamental design for a body massager, as shown and described.

DESCRIPTION

FIG. 1 is a top elevational view of a body massager showing my new design;

FIG. 2 is a bottom elevational view thereof;

FIG. 3 is a front elevational view thereof;

FIG. 4 is a rear elevational view thereof;

FIG. 5 is a left side elevational view thereof;

FIG. 6 is a right side elevational view thereof; and,

FIG. 7 is a top perspective view thereof.

1 Claim, 5 Drawing Sheets

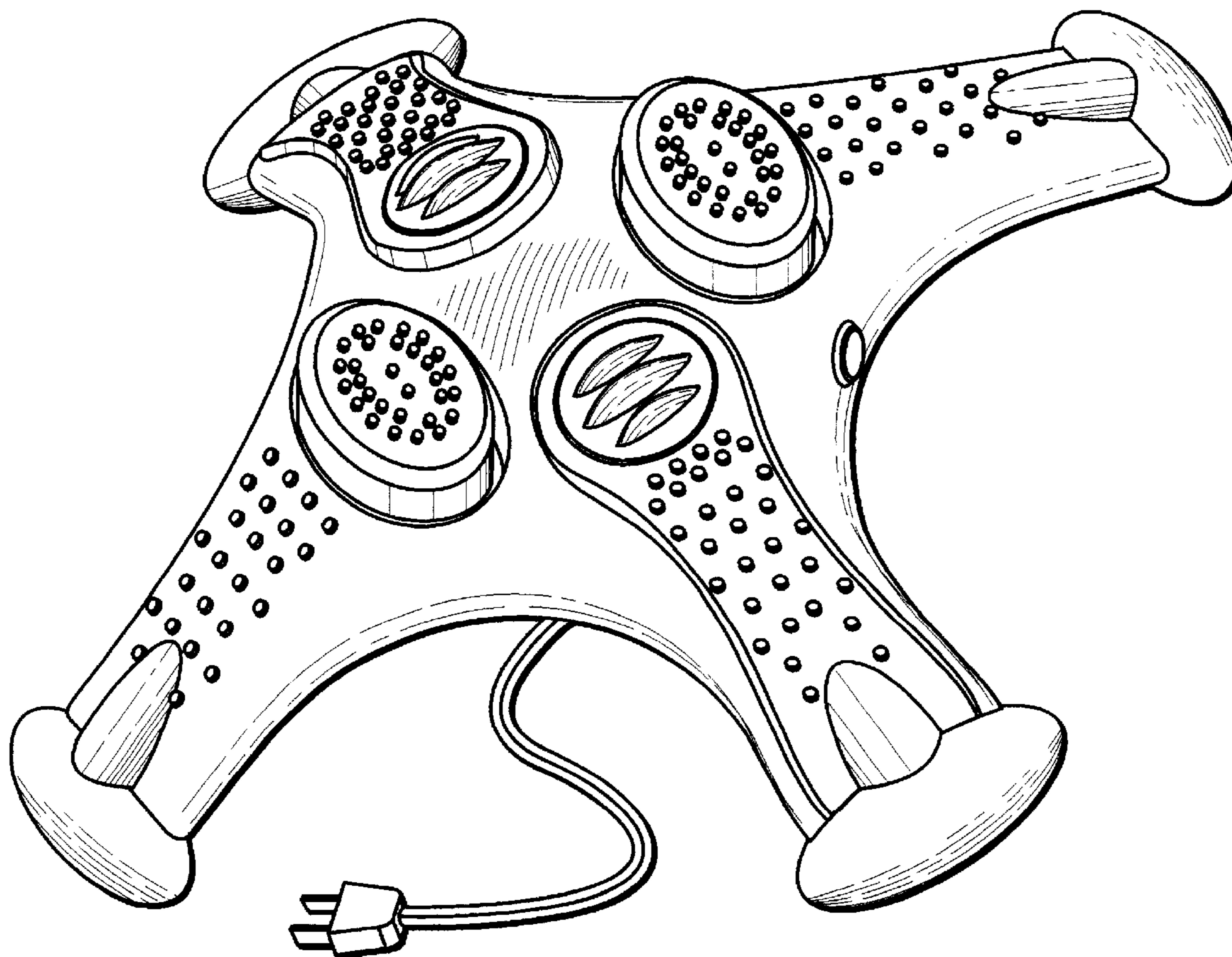

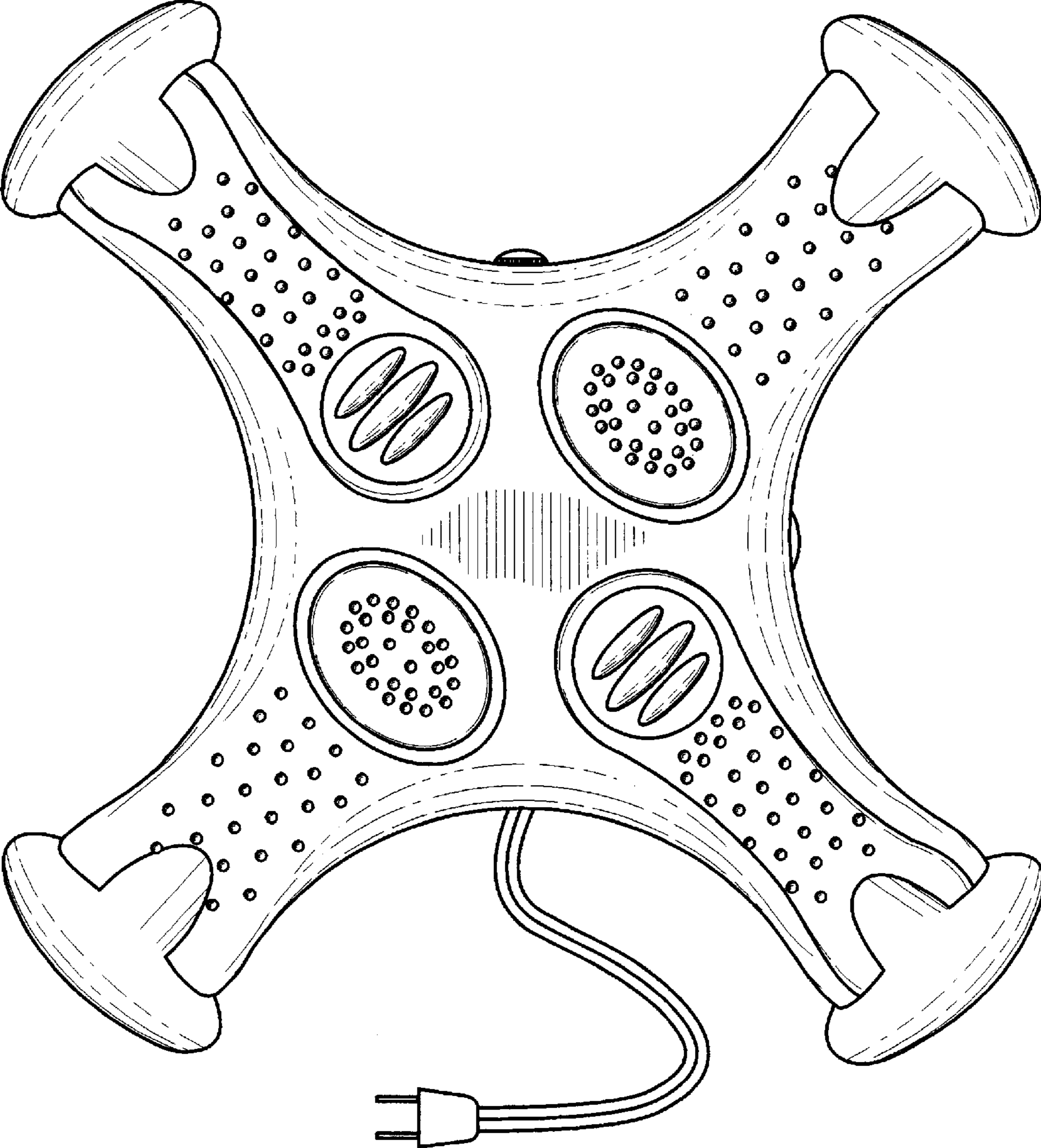

FIG. 1

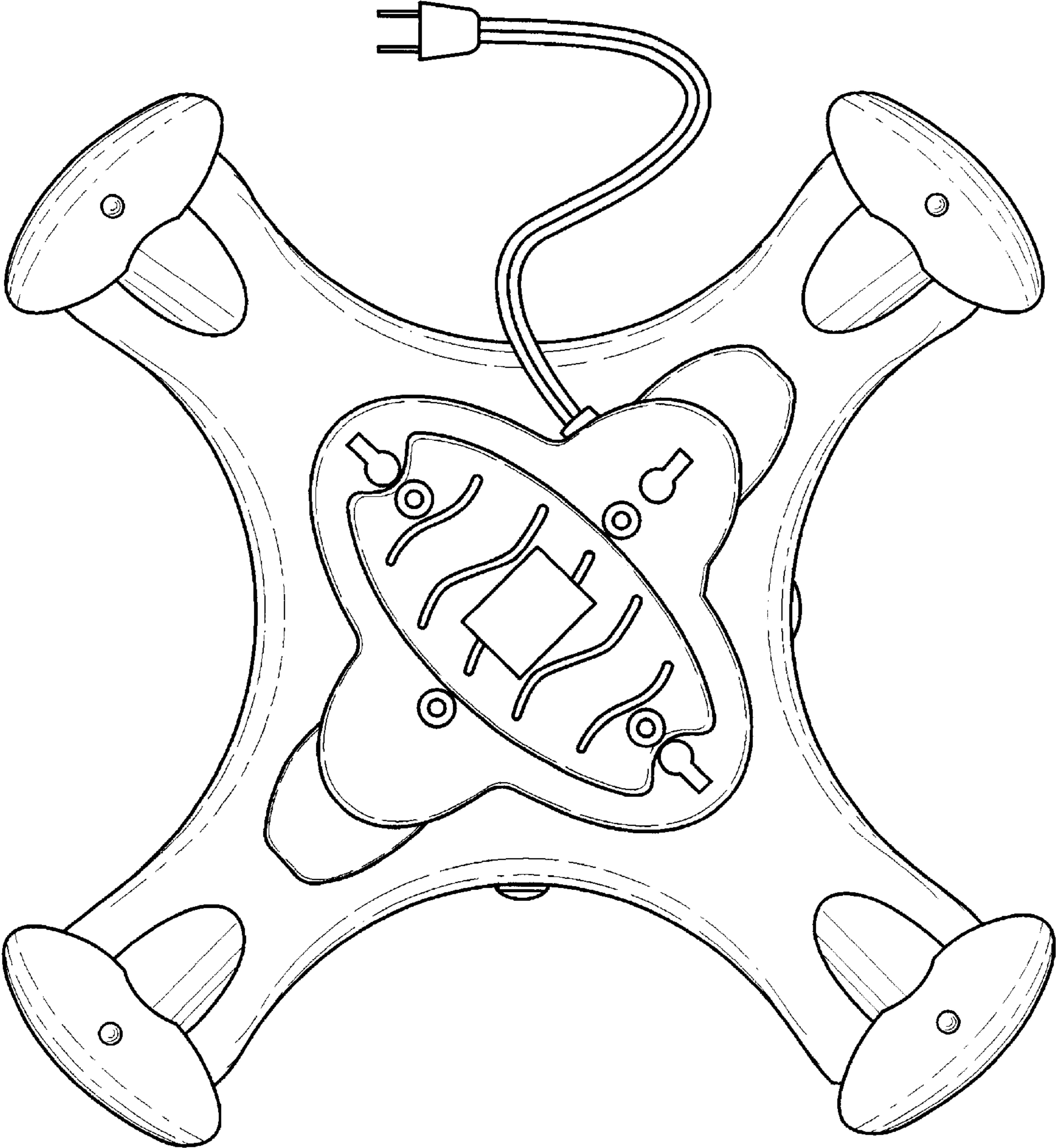

FIG. 2

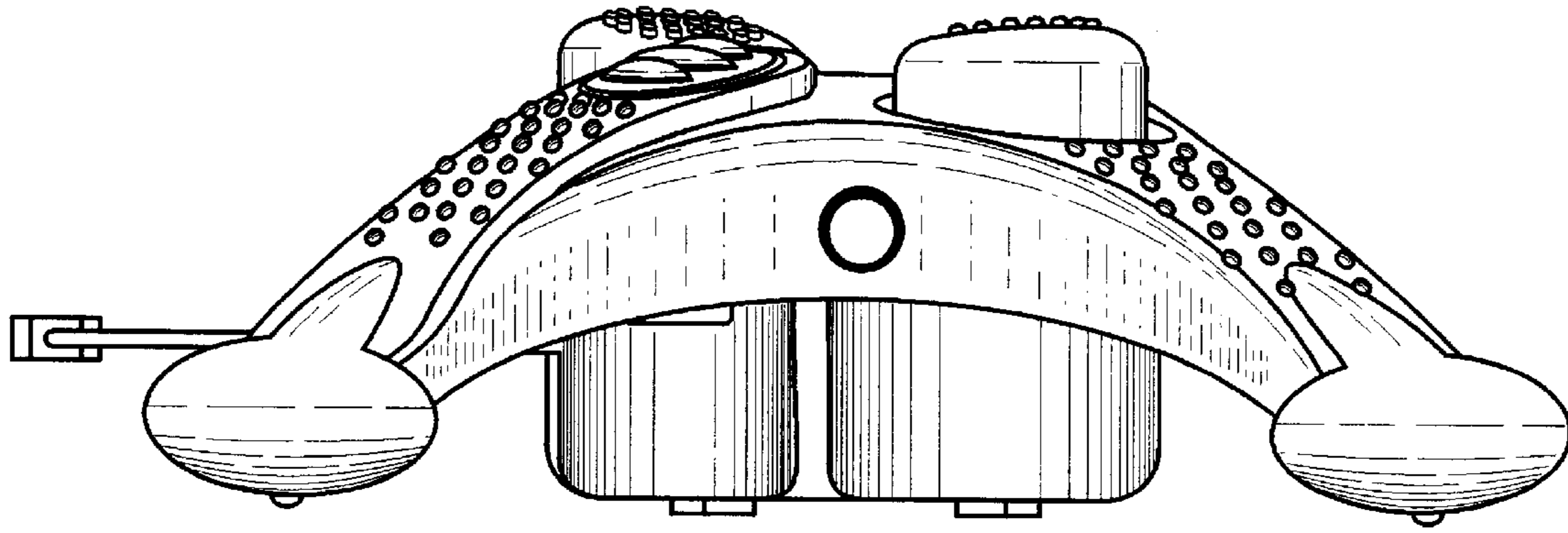

FIG. 3

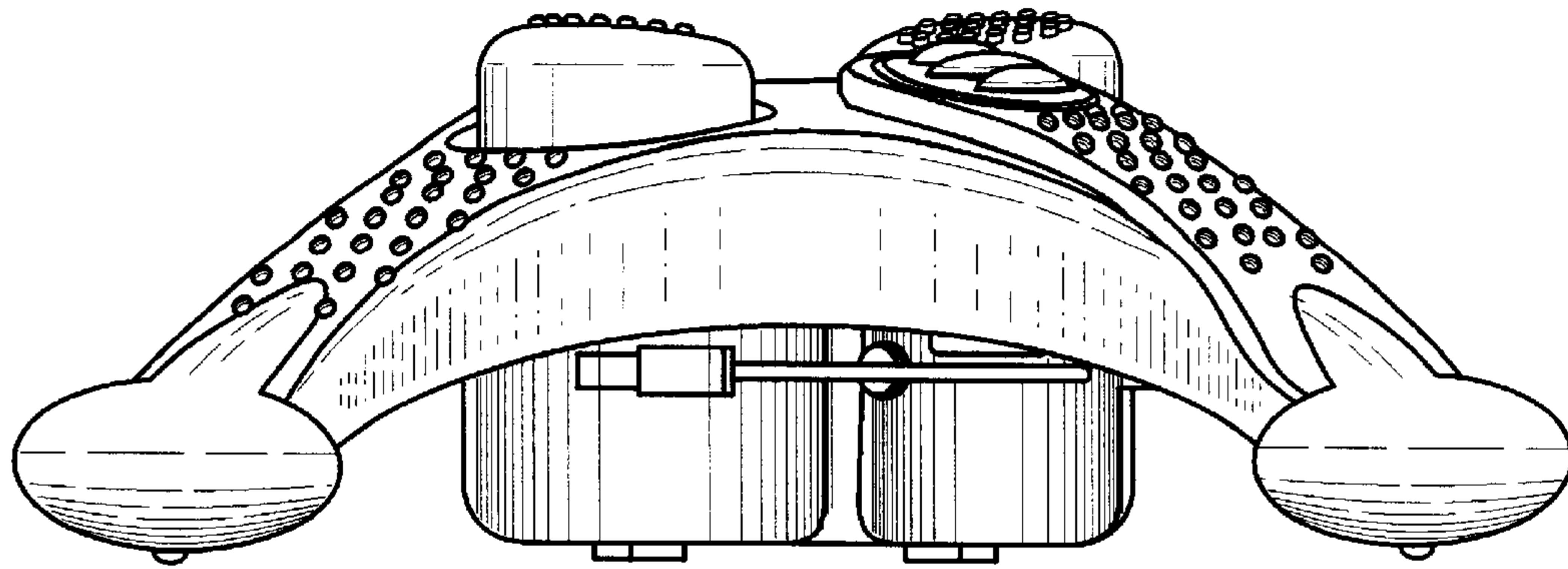

FIG. 4

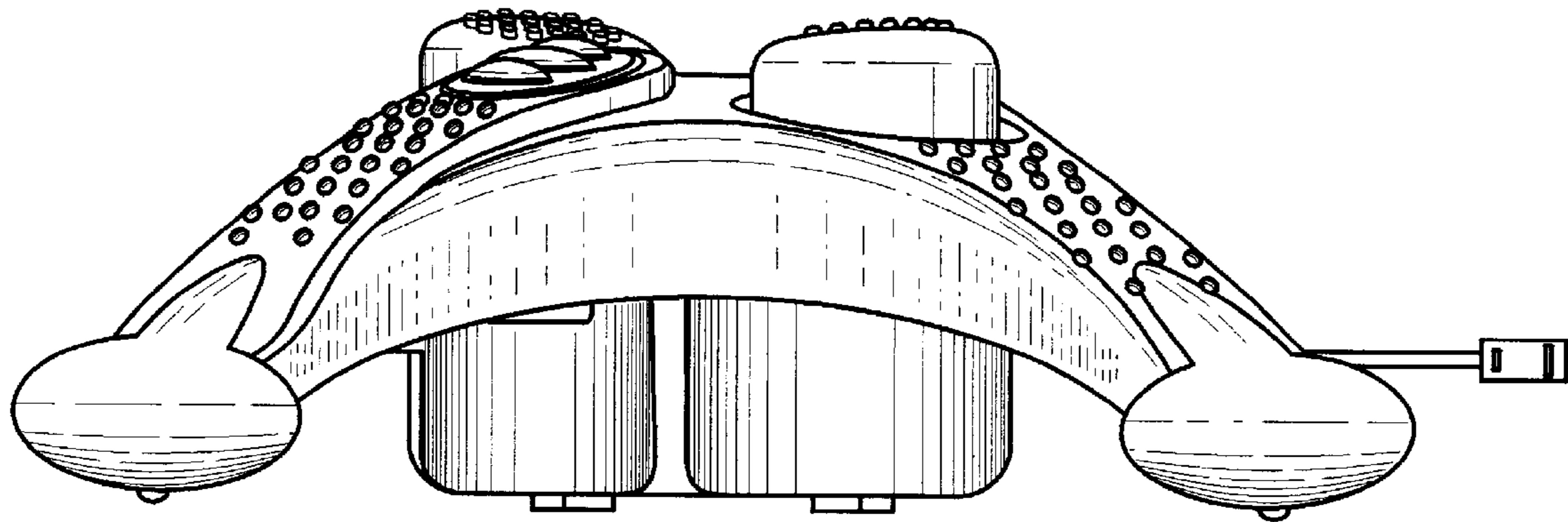

FIG. 5

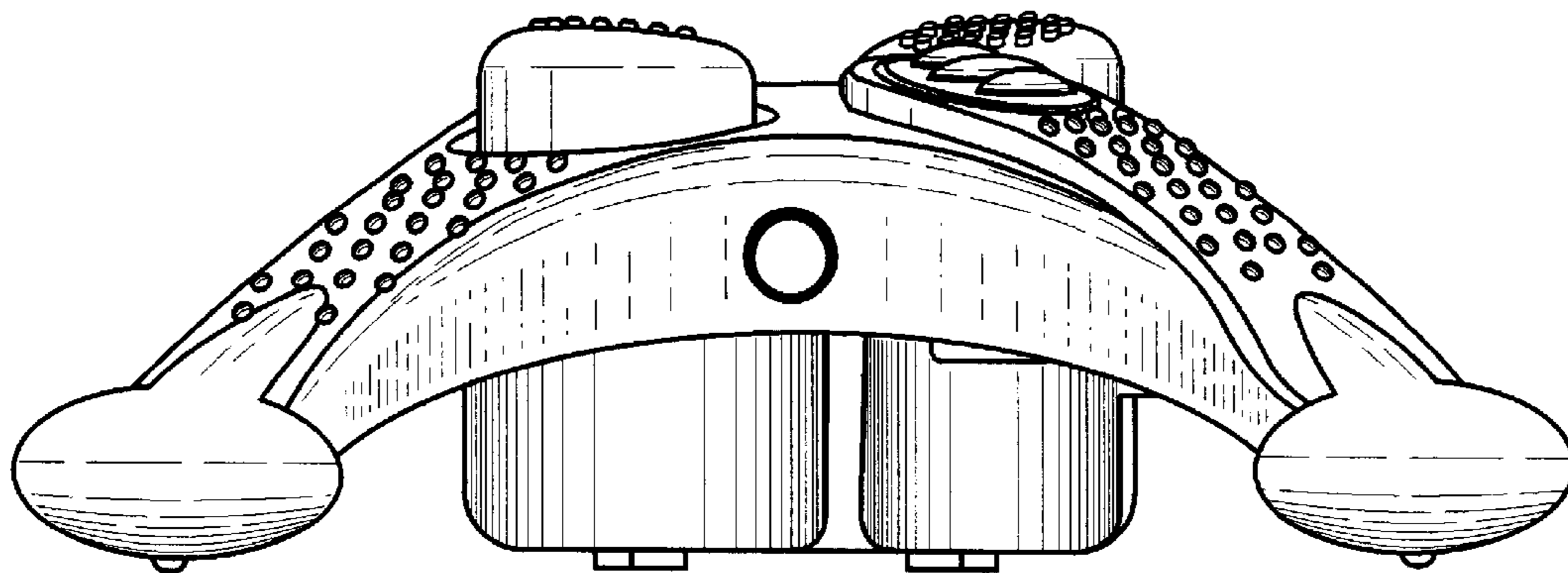

FIG. 6

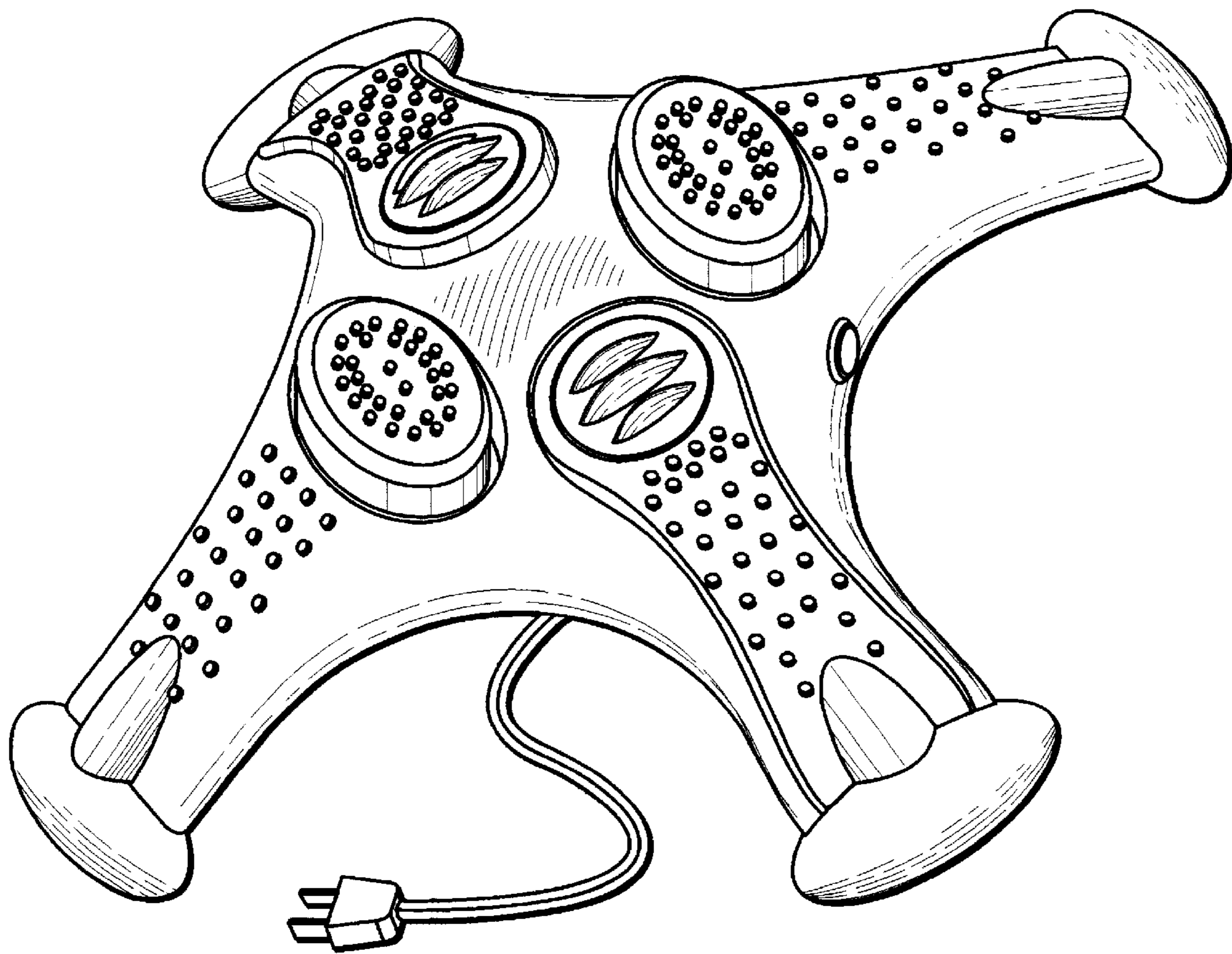

FIG. 7