

US00D520114S

(12) **United States Design Patent**
Starck

(10) **Patent No.:** **US D520,114 S**

(45) **Date of Patent:** **** May 2, 2006**

(54) **SANITARY FAUCET**

(75) Inventor: **Philippe Starck**, Paris (FR)

(73) Assignee: **Hansgrohe AG**, Schiltach (DE)

(**) Term: **14 Years**

(21) Appl. No.: **29/214,656**

(22) Filed: **Oct. 6, 2004**

(30) **Foreign Application Priority Data**

Apr. 7, 2004 (EM) 000162706

(51) **LOC (8) Cl.** **23-01**

(52) **U.S. Cl.** **D23/238**

(58) **Field of Classification Search** D23/238-257;
4/675-678; 137/801

See application file for complete search history.

(56) **References Cited**

U.S. PATENT DOCUMENTS

D420,726 S	*	2/2000	Slothower et al.	D23/257
D479,579 S	*	9/2003	Haug et al.	D23/238
D500,841 S	*	1/2005	Citterio	D23/238

OTHER PUBLICATIONS

Rubinetteria La Torre (catalog), Mar. 2003, p. 20.
KWC (catalog), 2003, one page from catalog.
FRANKE (catalog), Apr. 1, 2004, one page from catalog.
TEKNOBILI (catalog), 2003, p. 31.

* cited by examiner

Primary Examiner—Louis S. Zarfaz

Assistant Examiner—Gregory Andoll

(74) *Attorney, Agent, or Firm*—Duane Morris LLP

(57) **CLAIM**

The ornamental design for a sanitary faucet, as shown and described.

DESCRIPTION

FIG. 1: is a side perspective view of the sanitary faucet showing my new design;

FIG. 2: is a front elevation view thereof;

FIG. 3: is a rear elevation view thereof;

FIG. 4: is a side elevation view thereof;

FIG. 5: is the opposite side elevation view thereof;

FIG. 6: is a top plan view thereof; and,

FIG. 7: is a bottom plan view thereof.

1 Claim, 7 Drawing Sheets

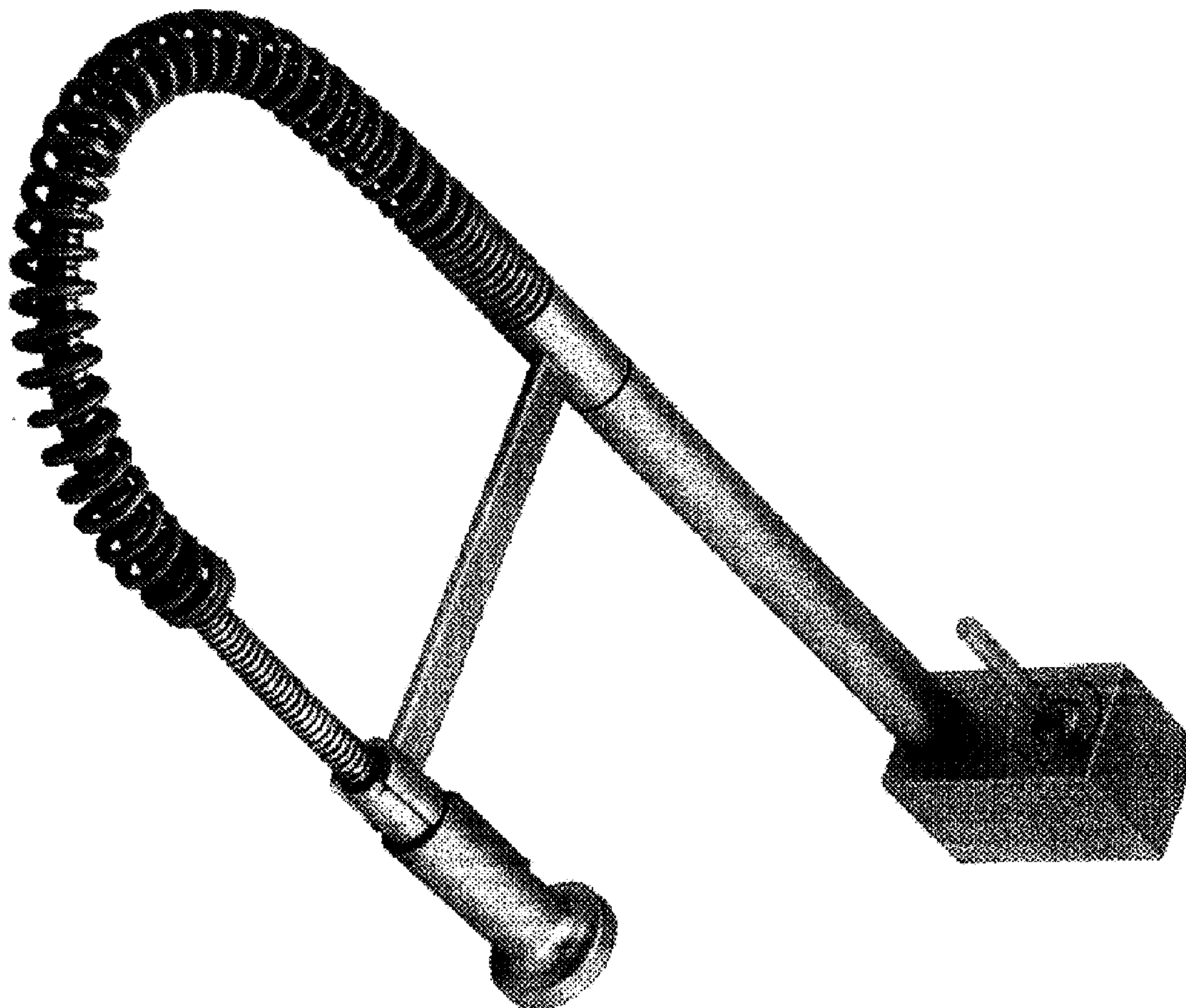

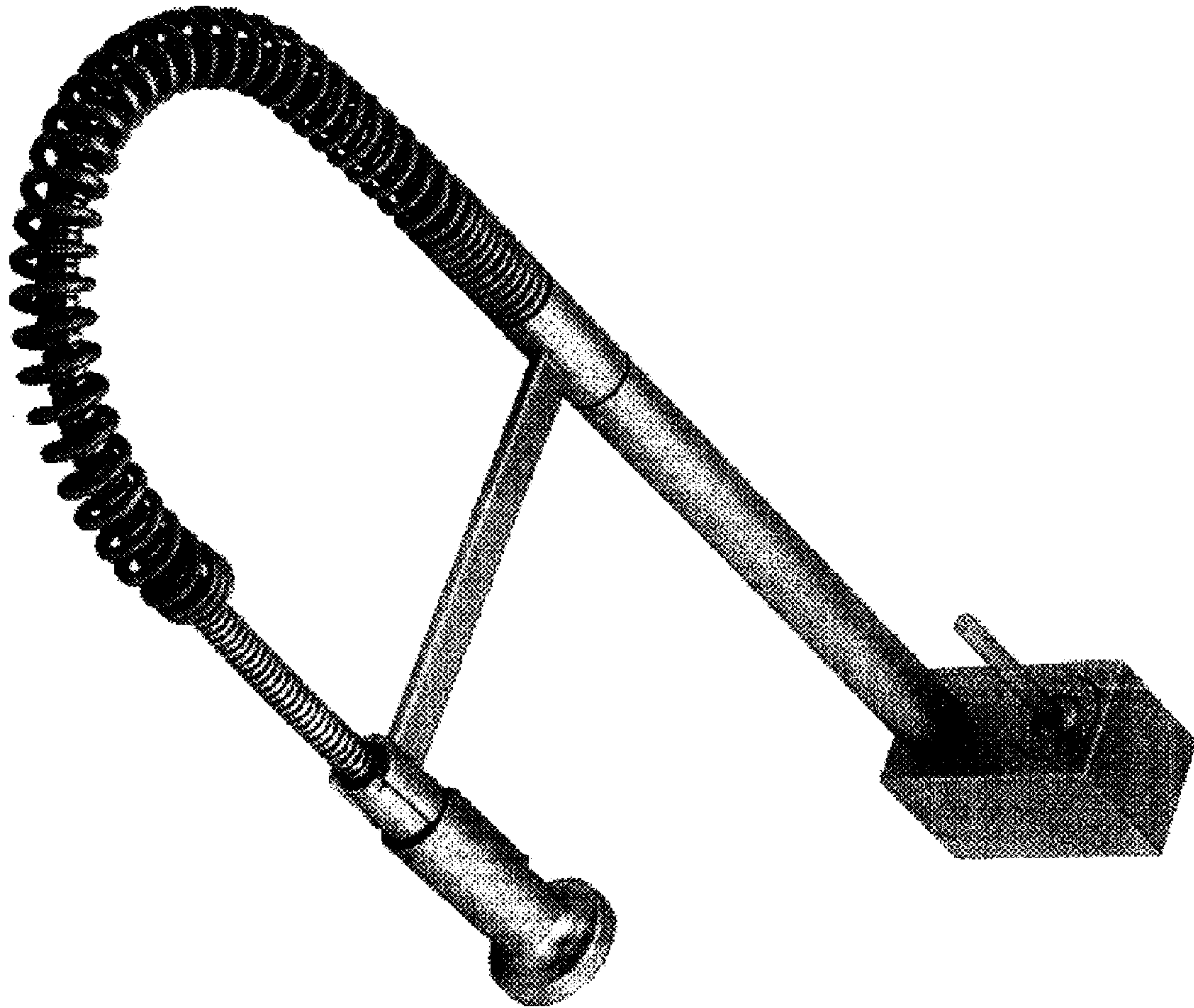

FIG. 1

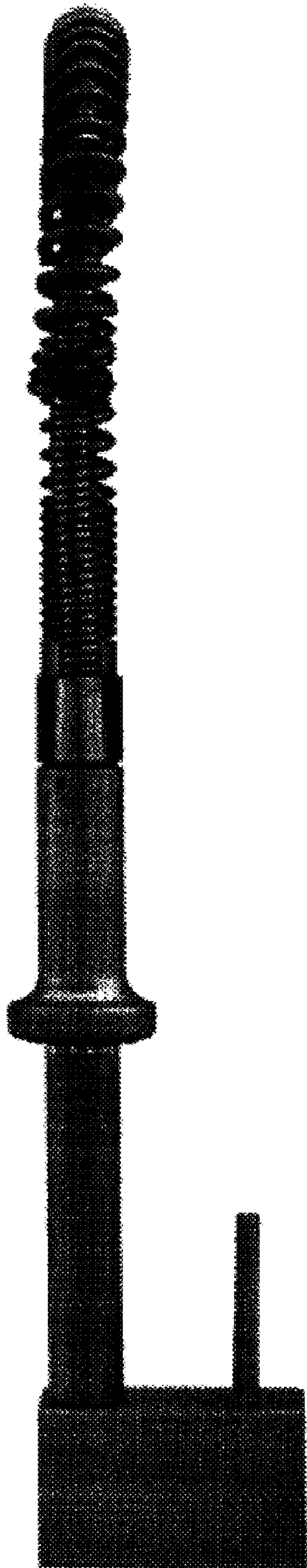

FIG. 2

FIG. 3

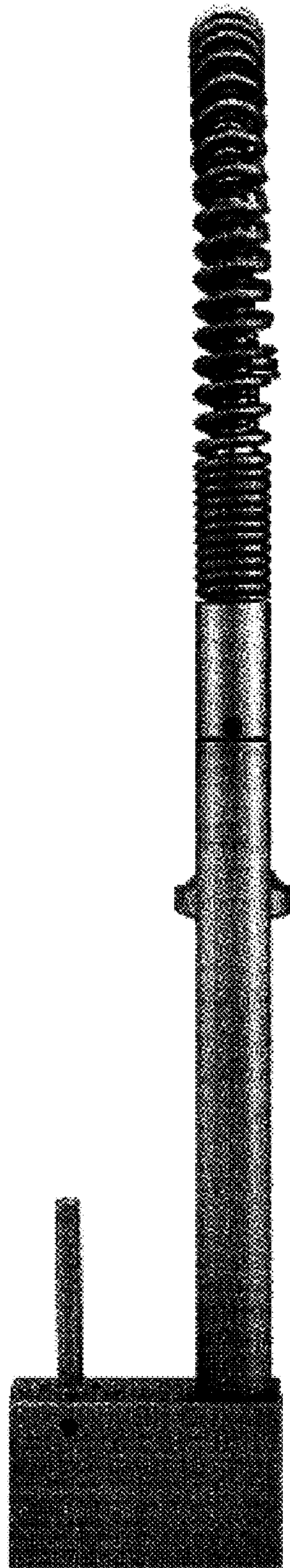

FIG. 4

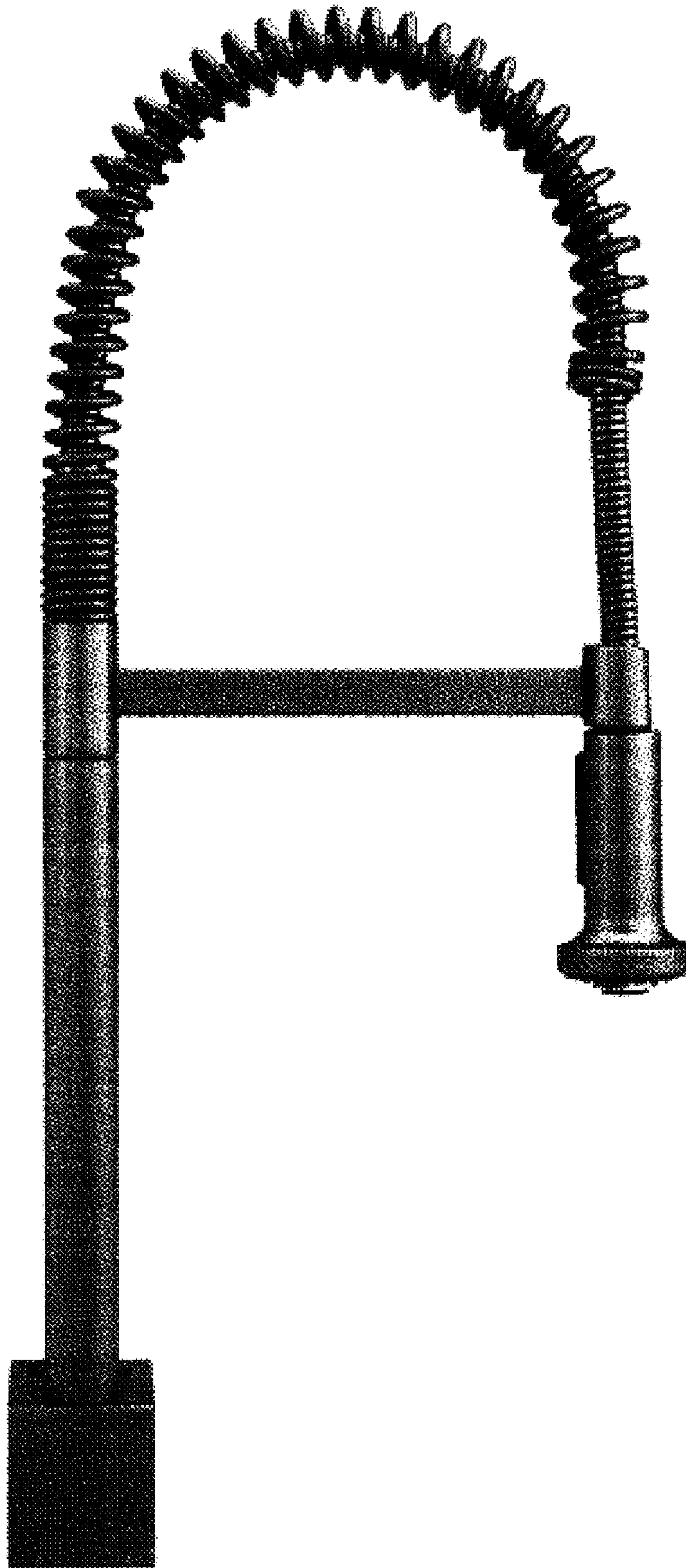

FIG. 5

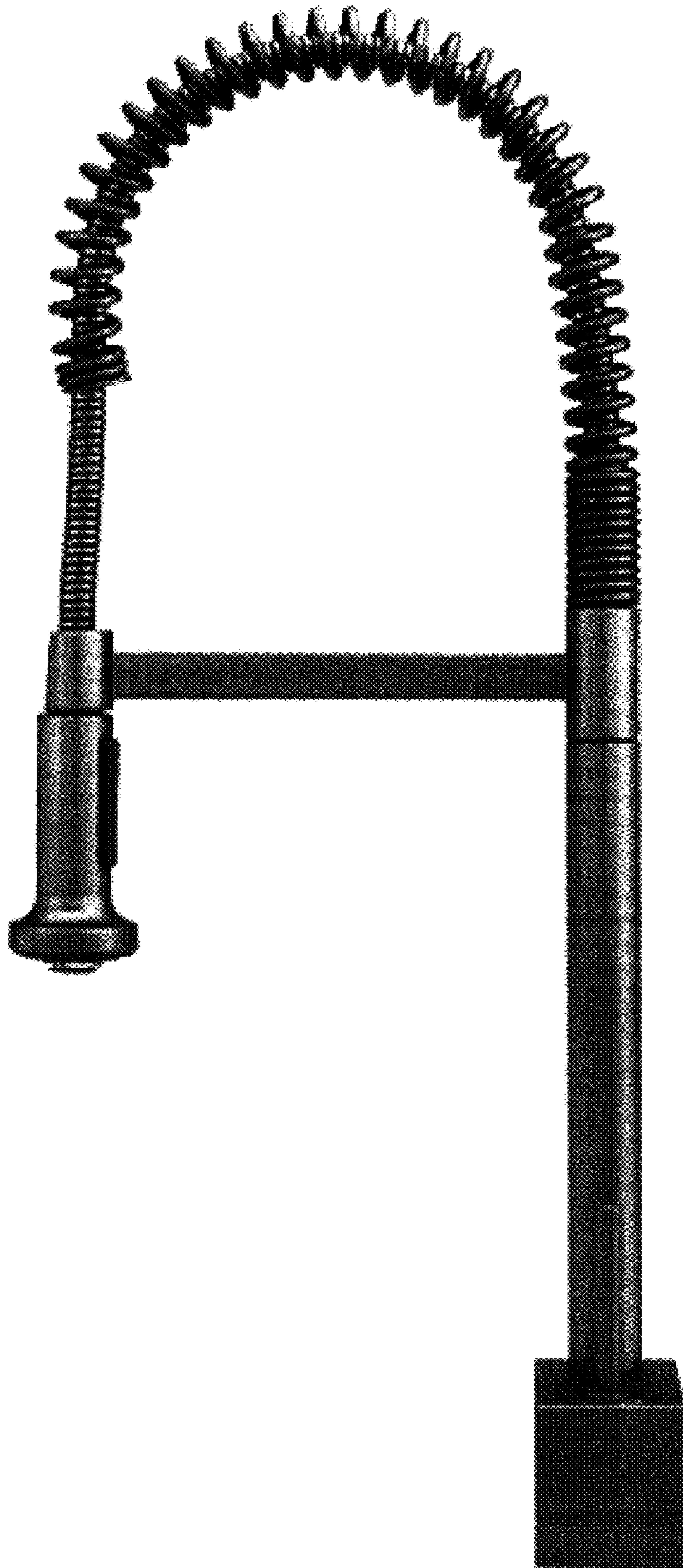

FIG. 6

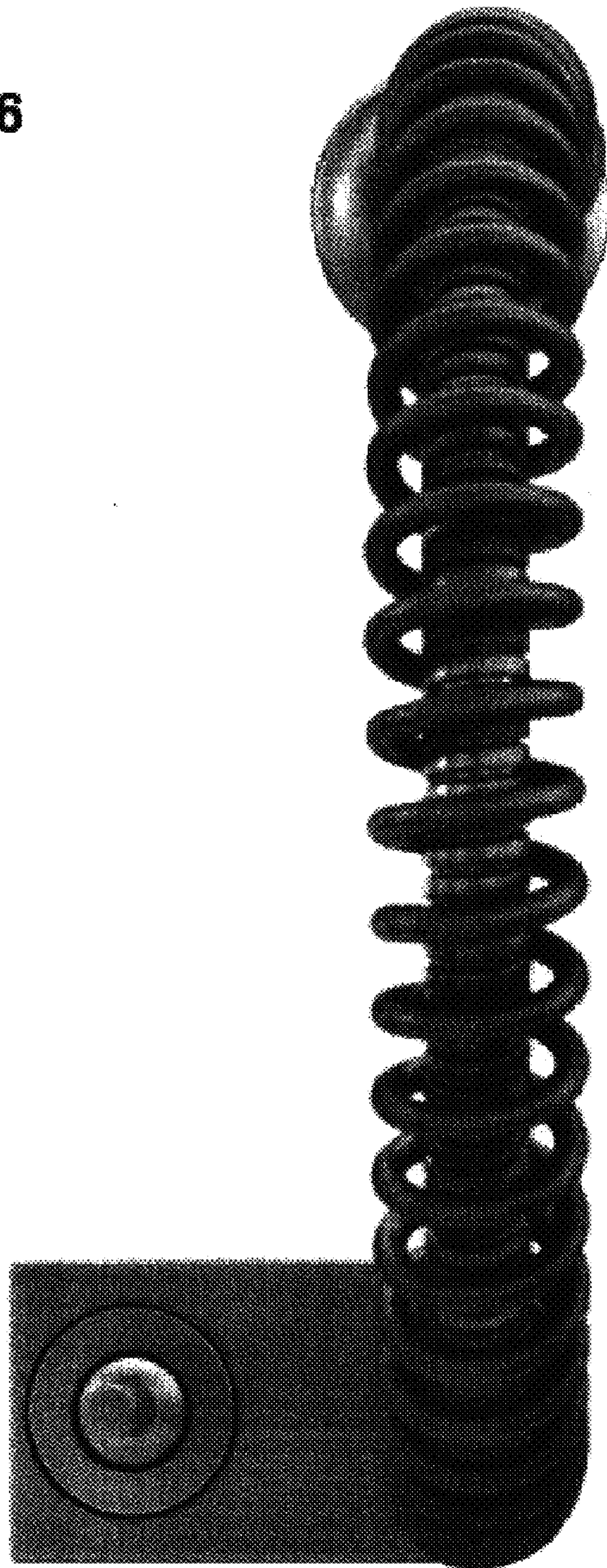



FIG. 7