

US00D520015S

(12) **United States Design Patent**  
**Peddle**

(10) **Patent No.:** **US D520,015 S**

(45) **Date of Patent:** **\*\* May 2, 2006**

(54) **COVER FOR MEMORY CHIPS ON A  
CIRCUIT BOARD**

(75) Inventor: **Charles I. Peddle**, Las Vegas, NV (US)

(73) Assignee: **Celetronix, Inc.**, Simi Valley, CA (US)

(\*\*) Term: **14 Years**

(21) Appl. No.: **29/168,585**

(22) Filed: **Oct. 4, 2002**

(51) **LOC (8) Cl.** ..... **14-02**

(52) **U.S. Cl.** ..... **D14/435**

(58) **Field of Classification Search** ..... D14/432-438;  
D13/182; 361/816, 748, 800  
See application file for complete search history.

(56) **References Cited**

**U.S. PATENT DOCUMENTS**

D257,723 S	*	12/1980	Stockdale	.....	D13/182
D261,760 S	*	11/1981	Dlugos	.....	D14/438
D294,579 S	*	3/1988	Kirpluk et al.	.....	D14/438
D296,787 S	*	7/1988	Hidaka et al.	.....	D14/438
D376,134 S	*	12/1996	Anton	.....	D13/182
5,867,371 A	*	2/1999	Denzene et al.	.....	361/816
D432,096 S	*	10/2000	Jeon et al.	.....	D13/182

\* cited by examiner

*Primary Examiner*—M. H. Tung

(74) *Attorney, Agent, or Firm*—Steven L. Nichols; Paul W. Fish; Rader, Fishman & Grauer PLLC

(57) **CLAIM**

The ornamental design for a cover for memory chips on a circuit board, as shown and described.

**DESCRIPTION**

FIG. 1 is a top plan view of a cover for memory chips on a circuit board showing my new design;

FIG. 2 is an inside view of the top portion, of the cover for memory chips on a circuit board;

FIG. 3 is a top plan view thereof;

FIG. 4 is a bottom plan view thereof;

FIG. 5 is a cross-sectional view thereof, taken along 5—5 of FIG. 1;

FIG. 6 is a front elevational view thereof;

FIG. 7 is a rear elevational view thereof;

FIG. 8 is an end elevational view thereof, the top portion is shown separately for clarity of illustration, the opposite end is a mirror image;

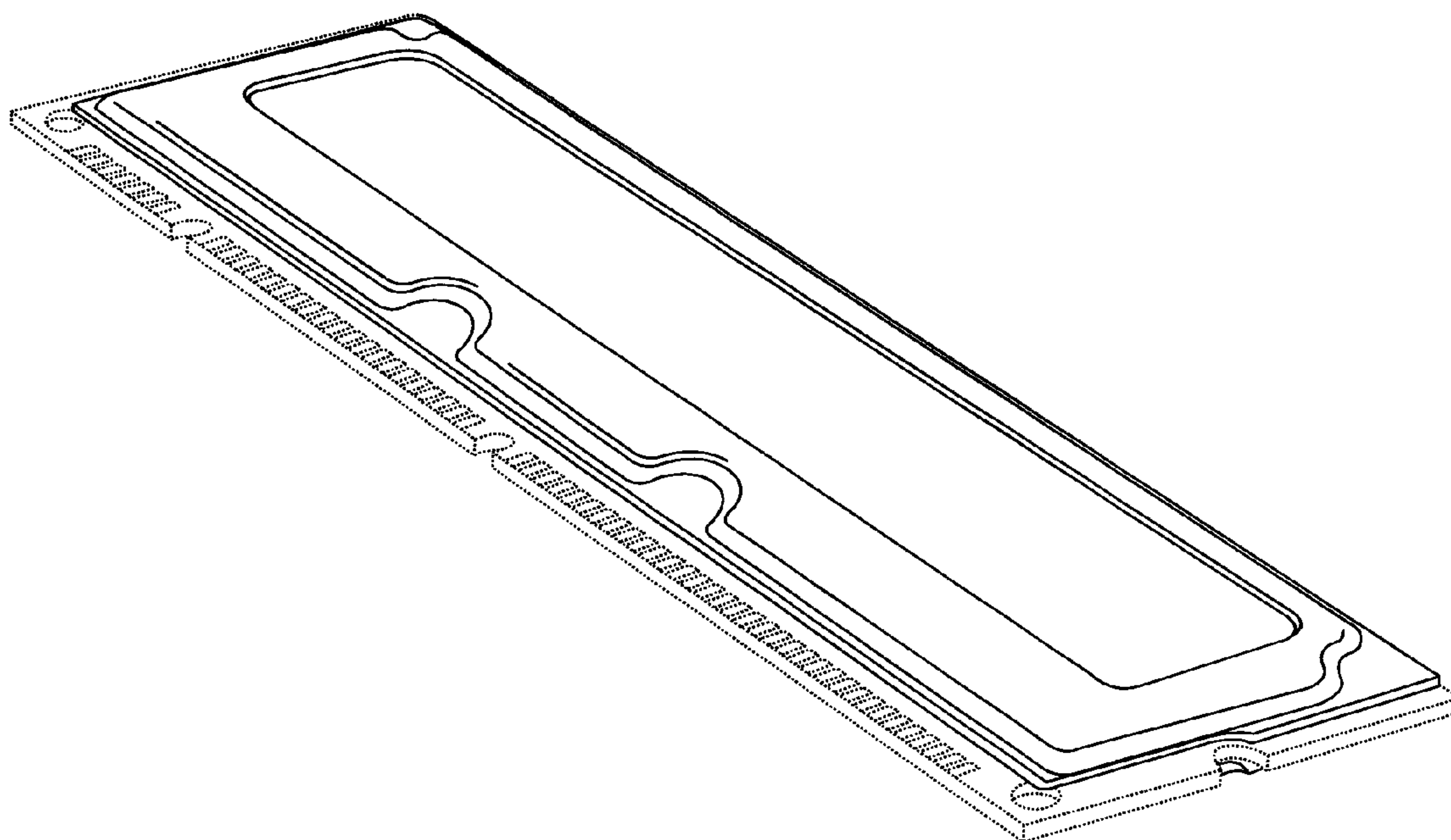
FIG. 9 is an end elevational view thereof;

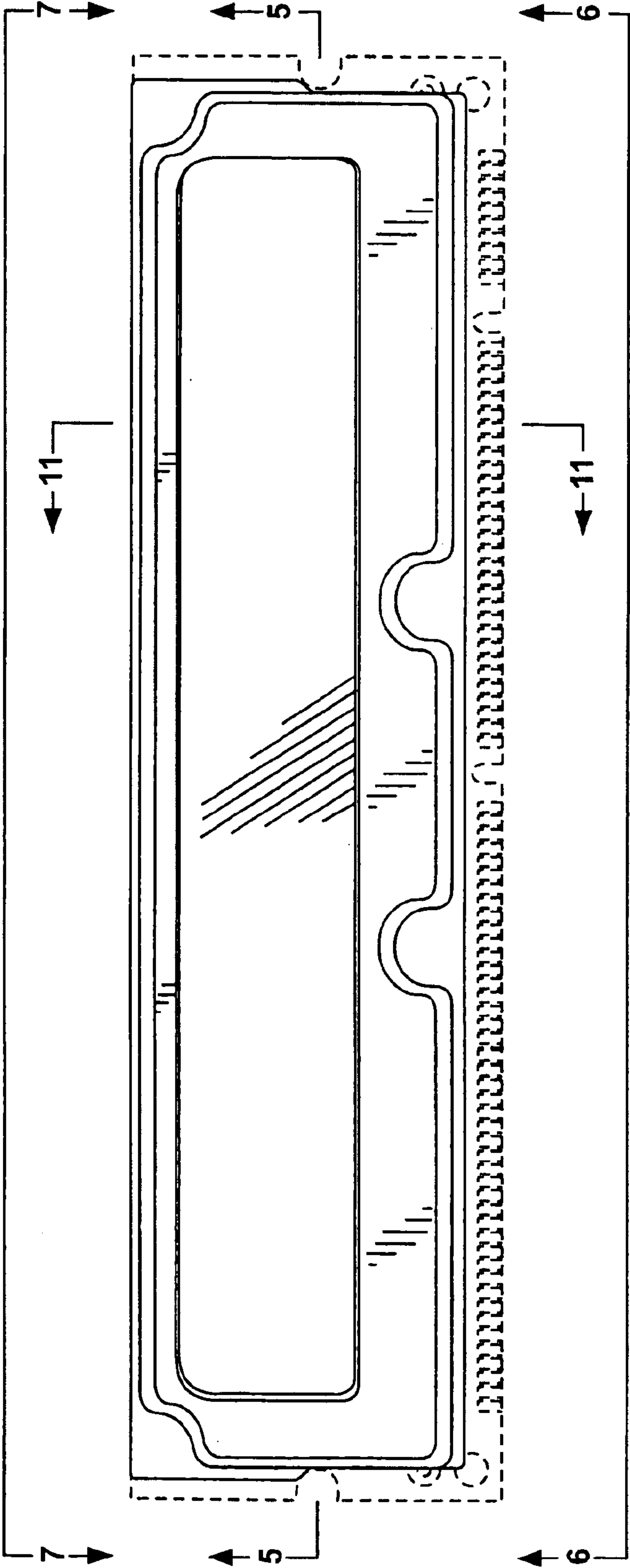
FIG. 10 is a top perspective view thereof, on a reduced scale; and,

FIG. 11 is a cross-sectional view thereof, taken on line 11—11 of FIG. 1.

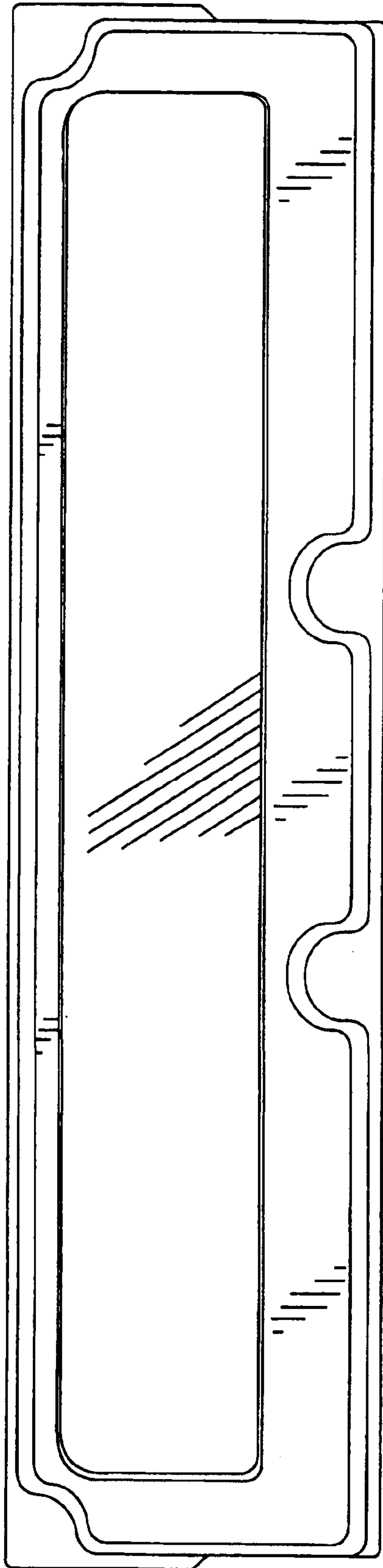
The broken line drawings of a circuit board in FIGS. 1, 4-7 and 9-11 is for illustrative purposes only and forms no part of the claimed design.

**1 Claim, 11 Drawing Sheets**

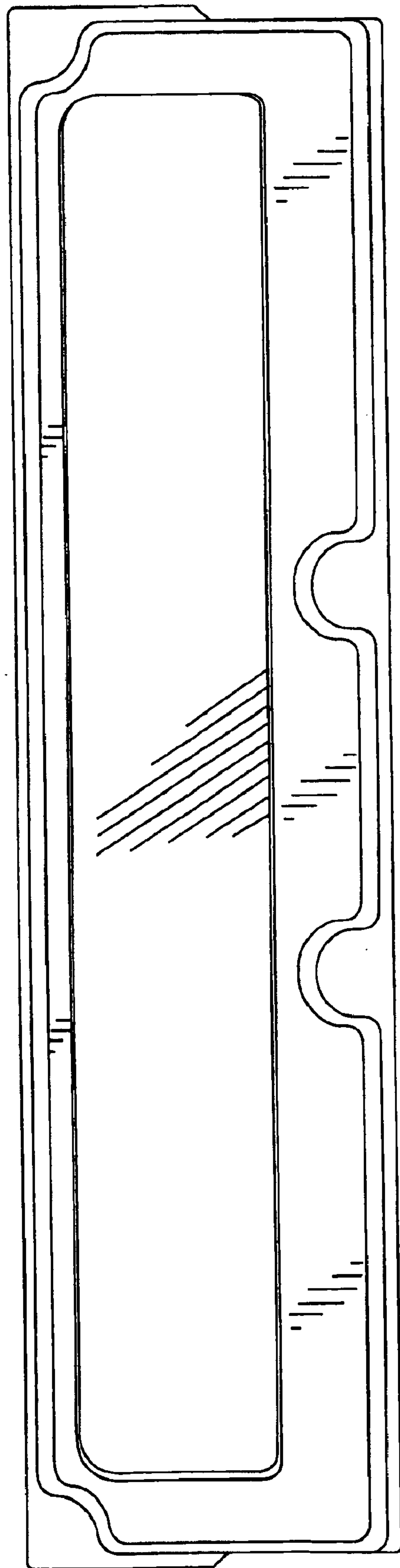




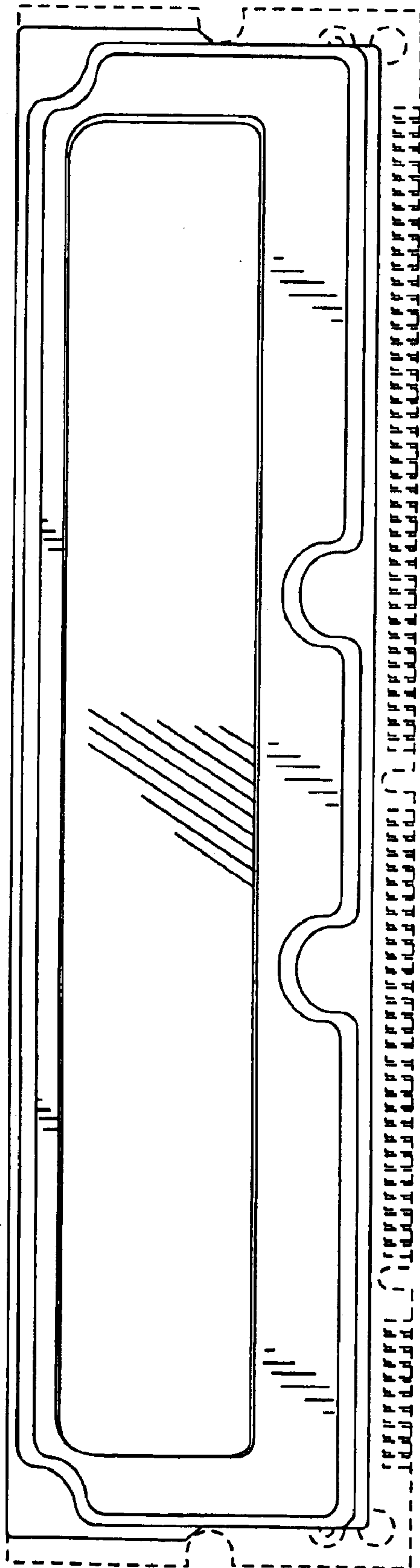
**Fig. 1**



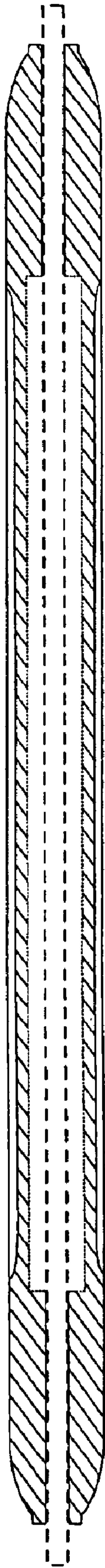
**Fig. 2**



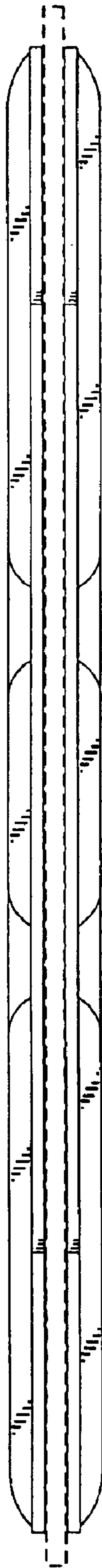
**Fig. 3**



**Fig. 4**

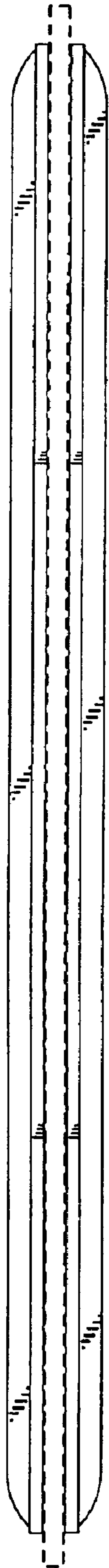


**Fig. 5**



**Fig. 6**



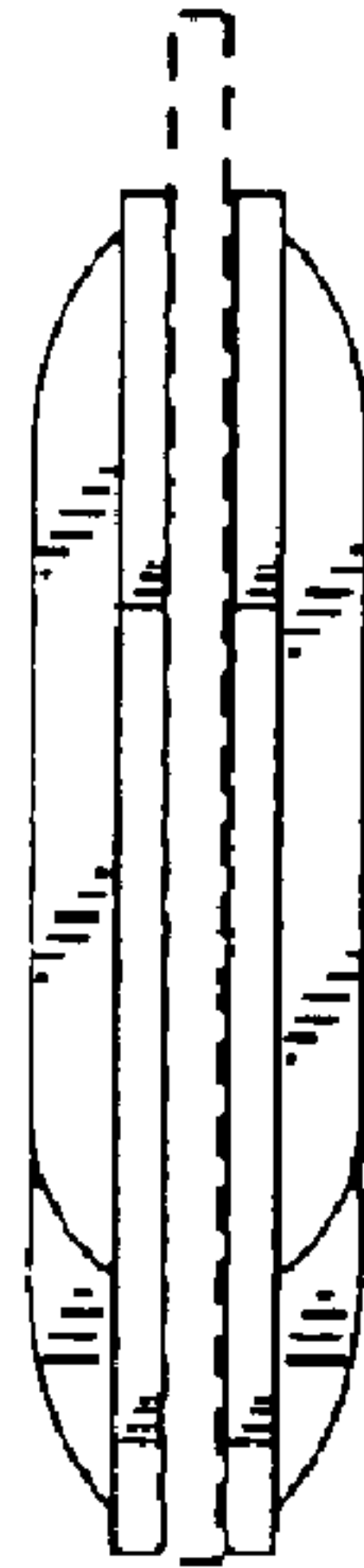


**Fig. 7**

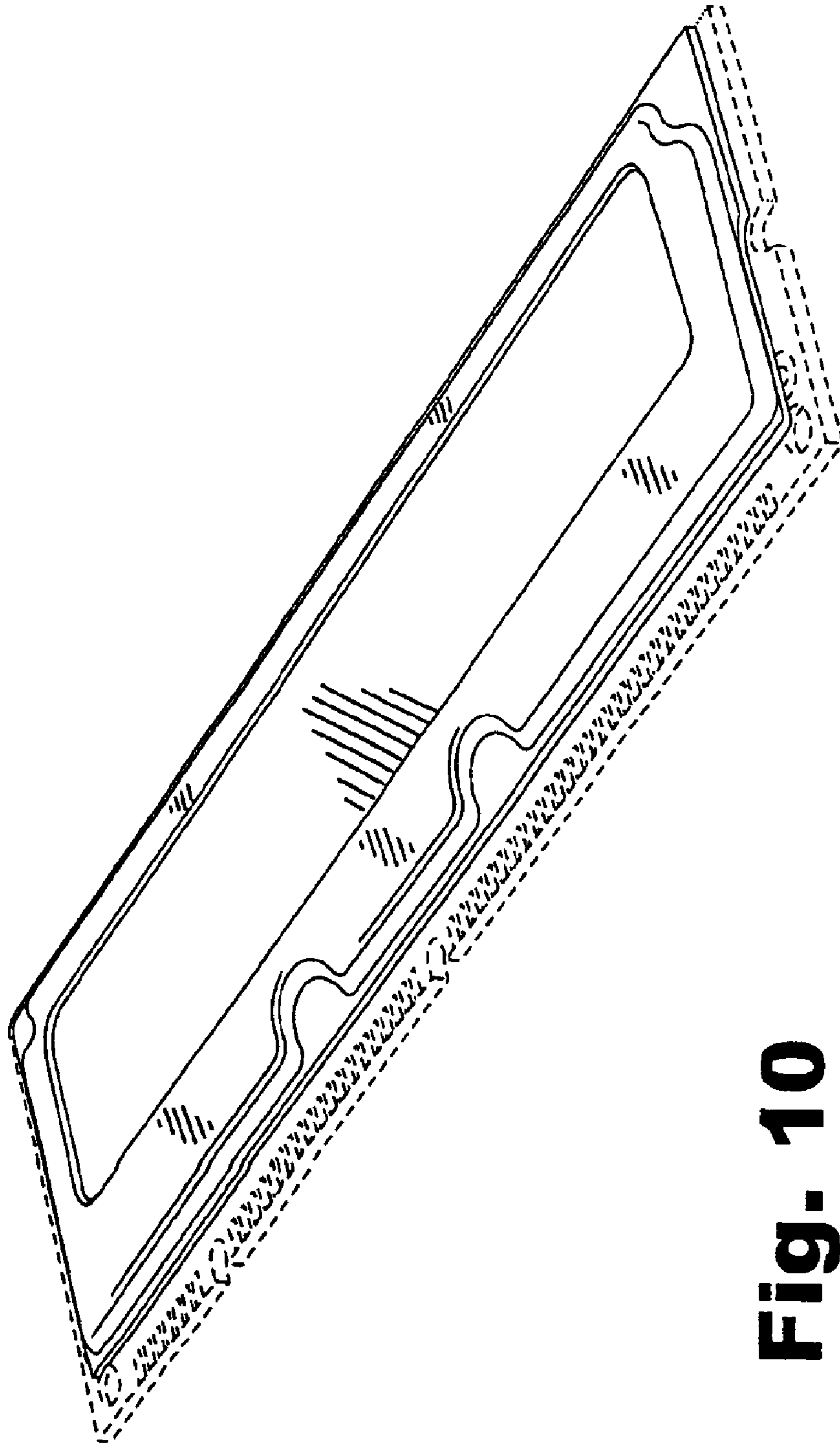




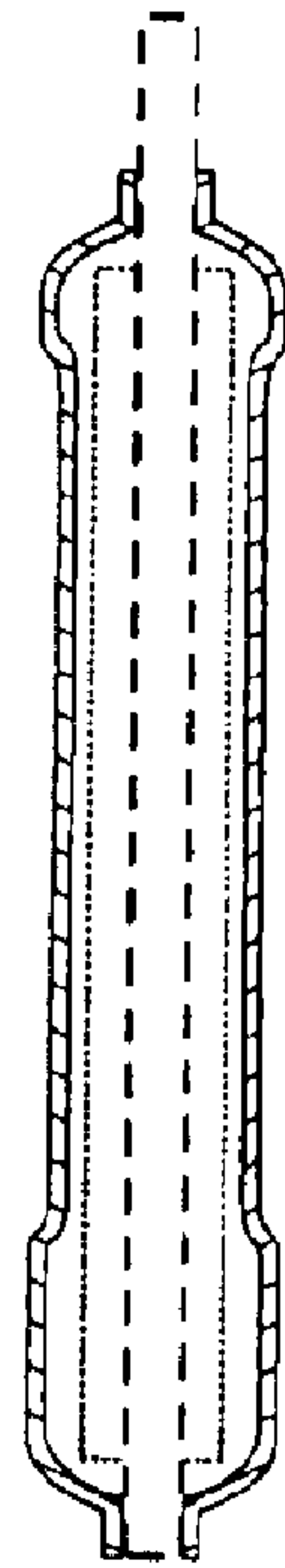
**Fig. 8**



**Fig. 9**



**Fig. 10**



**Fig. 11**