



US00D519994S

(12) **United States Design Patent**  
**Kettula et al.**

(10) **Patent No.:** **US D519,994 S**

(45) **Date of Patent:** **\*\* May 2, 2006**

(54) **HANDSFREE DEVICE FOR A HANDSET**

(75) Inventors: **Jan Kettula**, Espoo (FI); **Yossef Schvetz**, Milan (IT)

(73) Assignee: **Nokia Corporation**, Espoo (FI)

(\*\*) Term: **14 Years**

(21) Appl. No.: **29/217,905**

(22) Filed: **Nov. 24, 2004**

(30) **Foreign Application Priority Data**

May 26, 2004 (FI) ..... M20040087

(51) **LOC (8) Cl.** ..... **14-03**

(52) **U.S. Cl.** ..... **D14/248; D14/205; D13/107**

(58) **Field of Classification Search** ..... D14/107,  
D14/144, 248, 205, 225, 206, 223; D13/107,  
D13/108, 110, 144; 307/10.1; 439/668; 455/569.2;  
320/110-115

See application file for complete search history.

(56) **References Cited**

**U.S. PATENT DOCUMENTS**

5,170,067 A \* 12/1992 Baum et al. .... 307/10.1  
D341,123 S \* 11/1993 Hakanen et al. .... D13/108  
D356,571 S \* 3/1995 Garmon et al. .... D14/225

D369,811 S \* 5/1996 Chen ..... D14/248  
D373,756 S \* 9/1996 Chen ..... D13/108  
5,642,402 A \* 6/1997 Vilmi et al. .... 455/569.2  
D384,936 S \* 10/1997 Liebler ..... D13/103  
D433,379 S 11/2000 Jokinen  
D471,517 S \* 3/2003 Nazar ..... D13/110  
6,767,256 B1 \* 7/2004 Faerber et al. .... 439/668

\* cited by examiner

*Primary Examiner*—Paula A. Greene

(74) *Attorney, Agent, or Firm*—Banner & Witcoff, Ltd.

(57) **CLAIM**

The ornamental design for a handsfree device for a handset, as shown and described.

**DESCRIPTION**

FIG. 1 is a front view of a handsfree device for a handset showing my new design;  
FIG. 2 is a rear view thereof;  
FIG. 3 is a right side view thereof;  
FIG. 4 is a left side view thereof;  
FIG. 5 is a top plan view thereof;  
FIG. 6 is a bottom plan view thereof;  
FIG. 7 is a perspective front view thereof; and,  
FIG. 8 is a perspective rear view thereof.

**1 Claim, 5 Drawing Sheets**

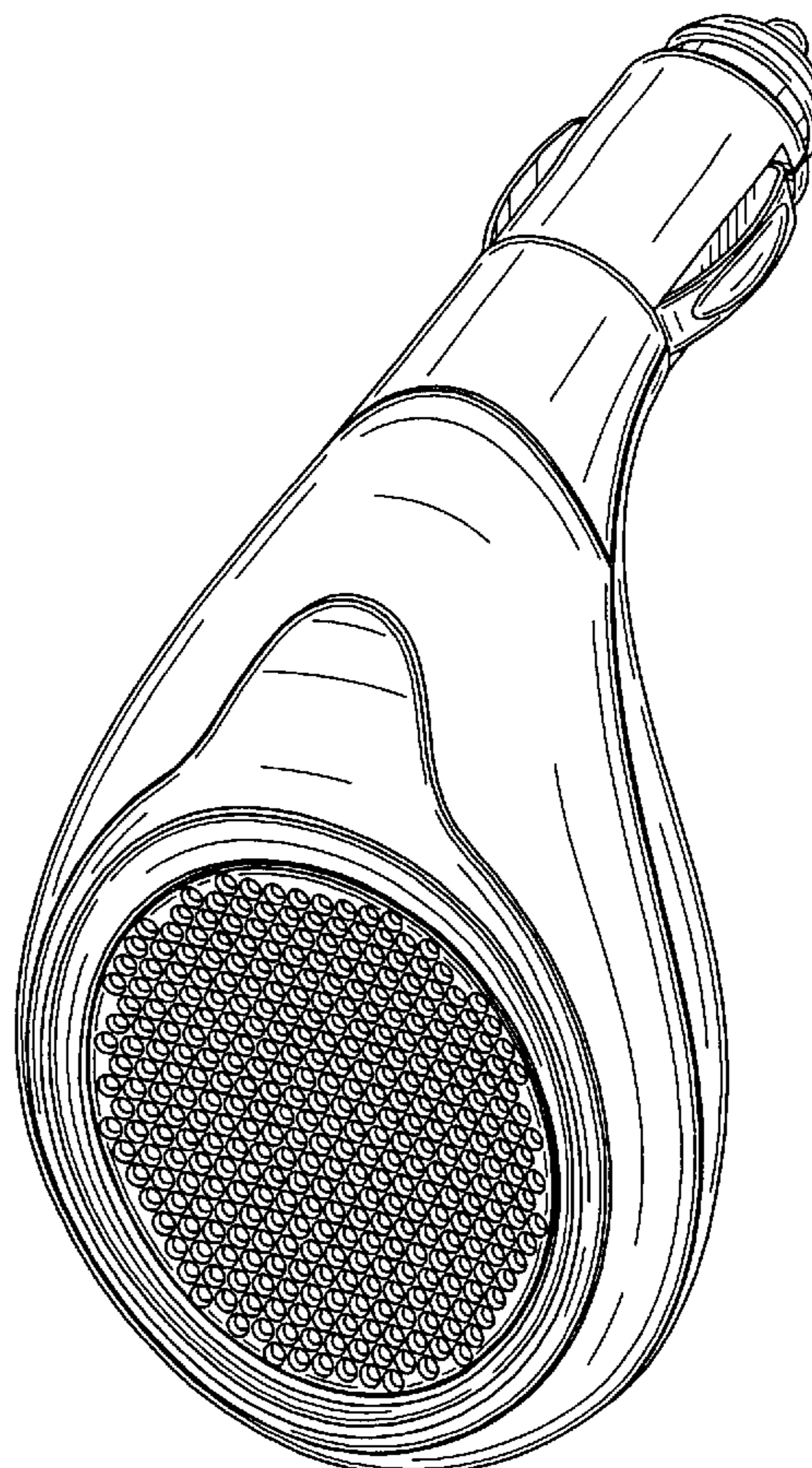
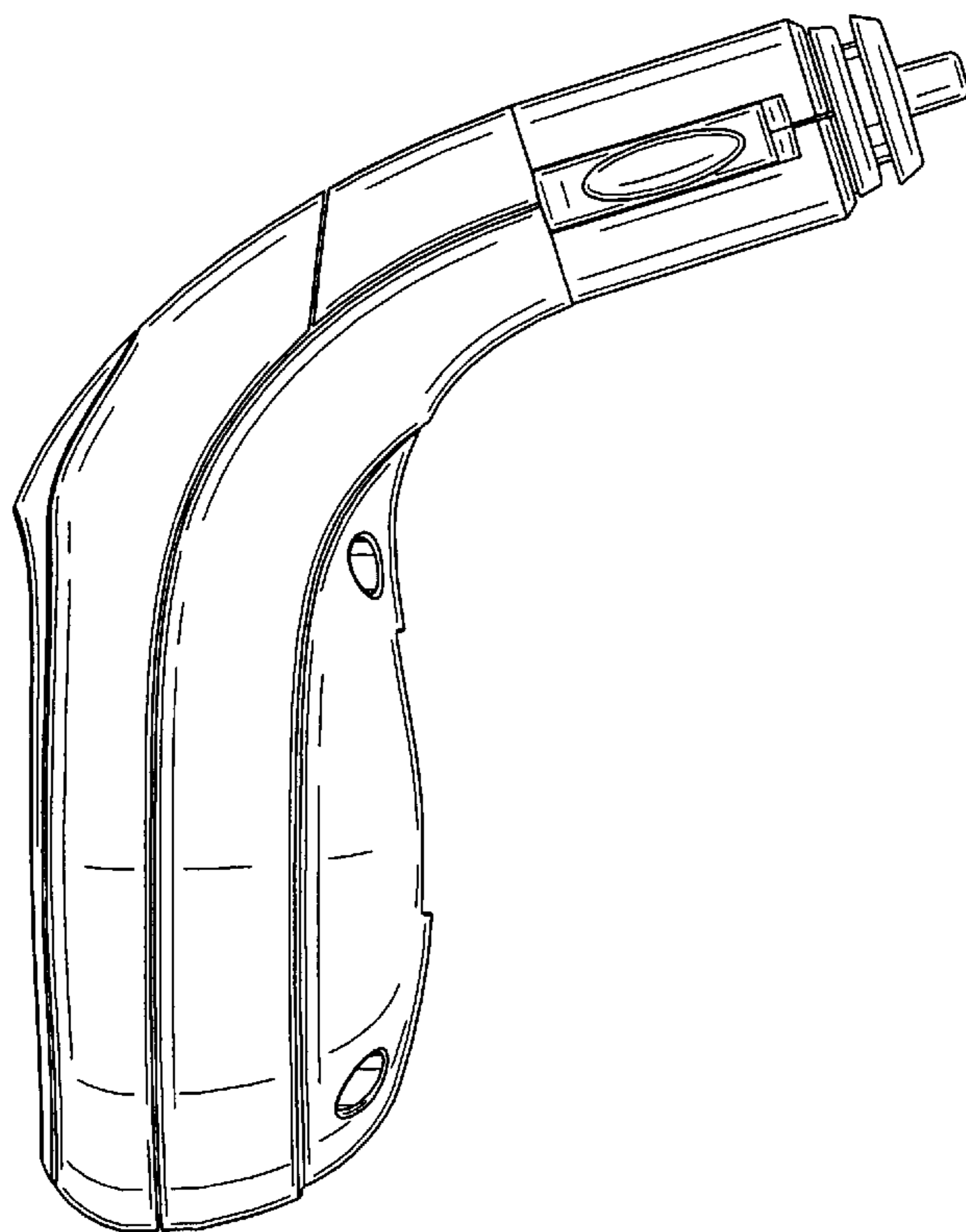

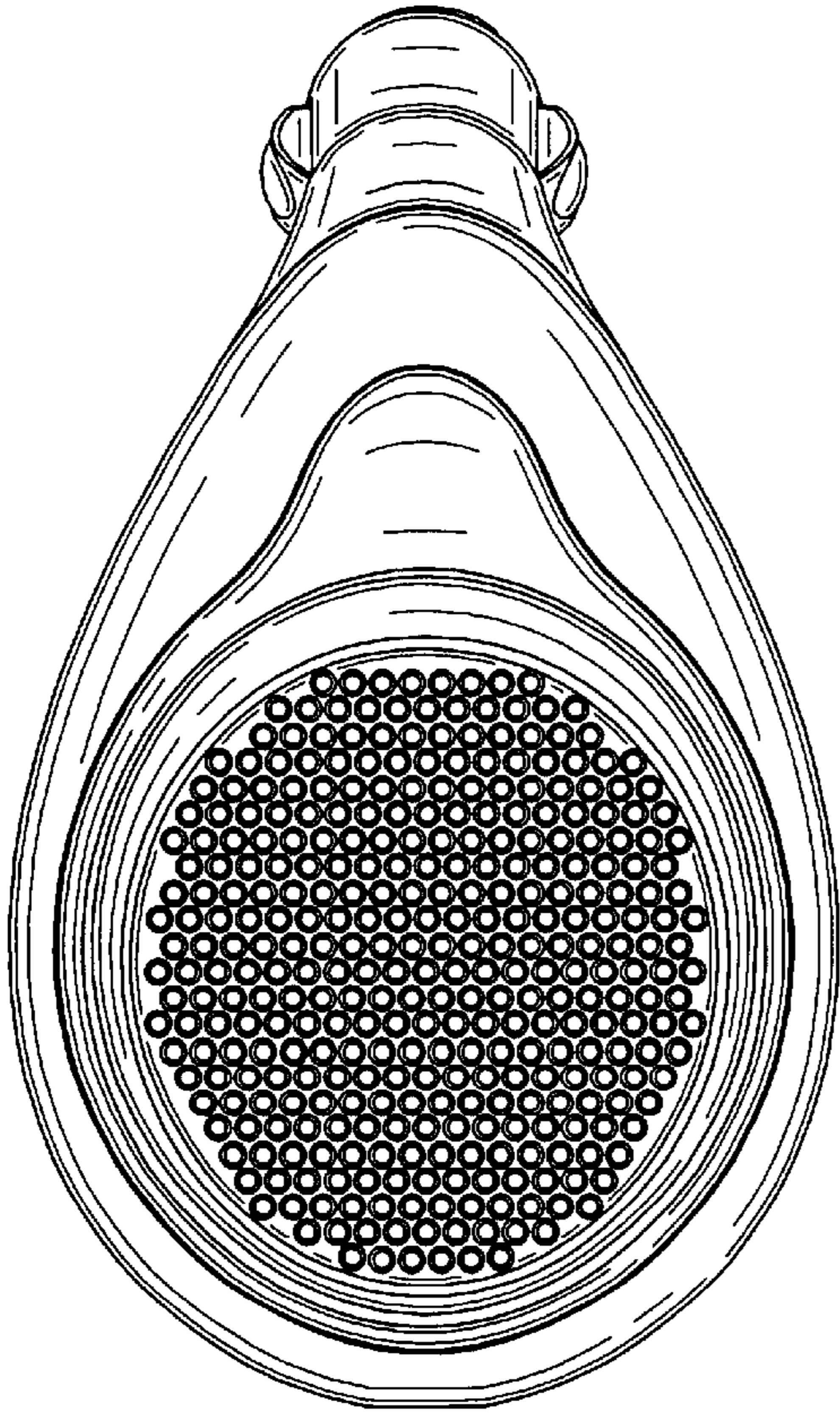

FIG. 1

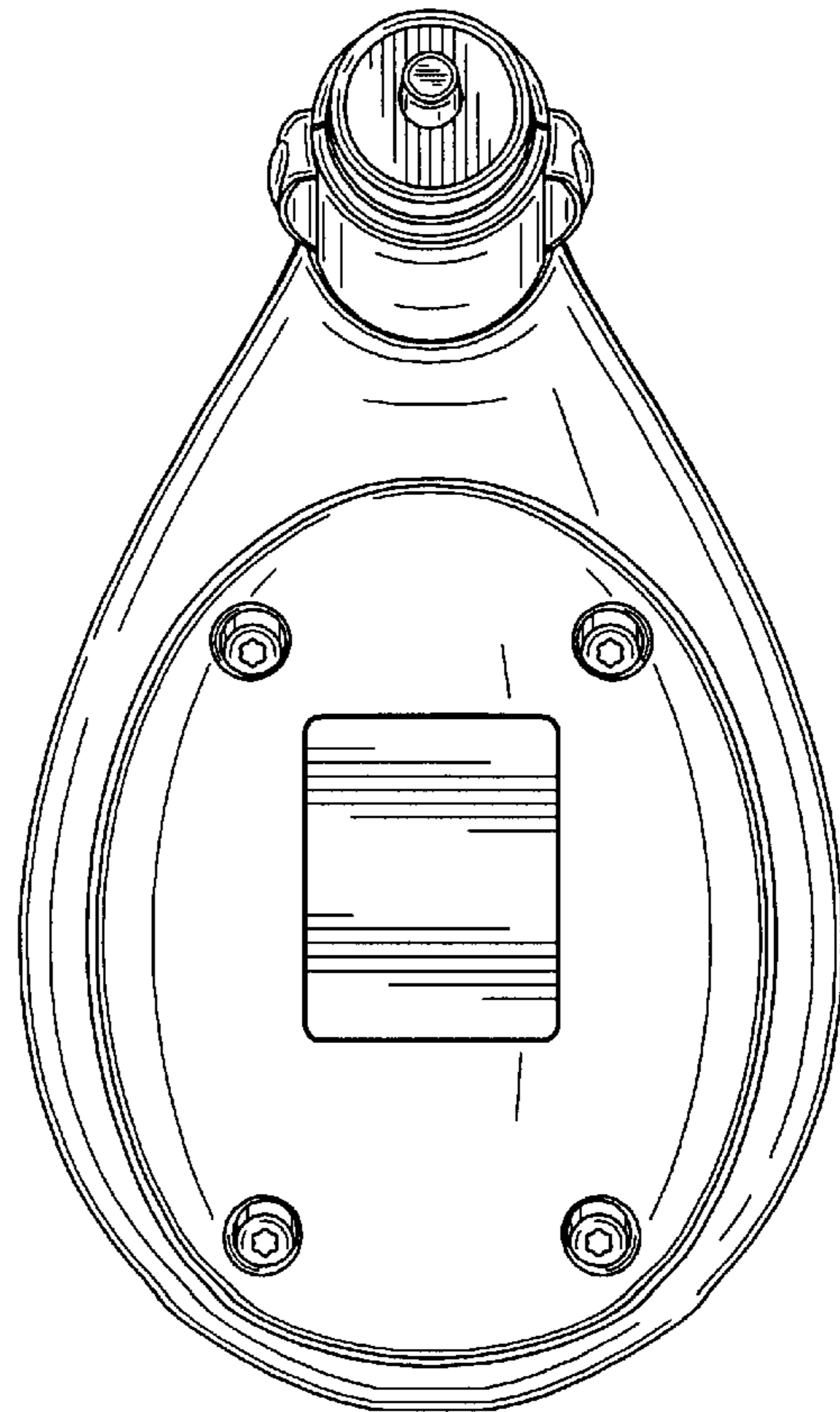

FIG. 2

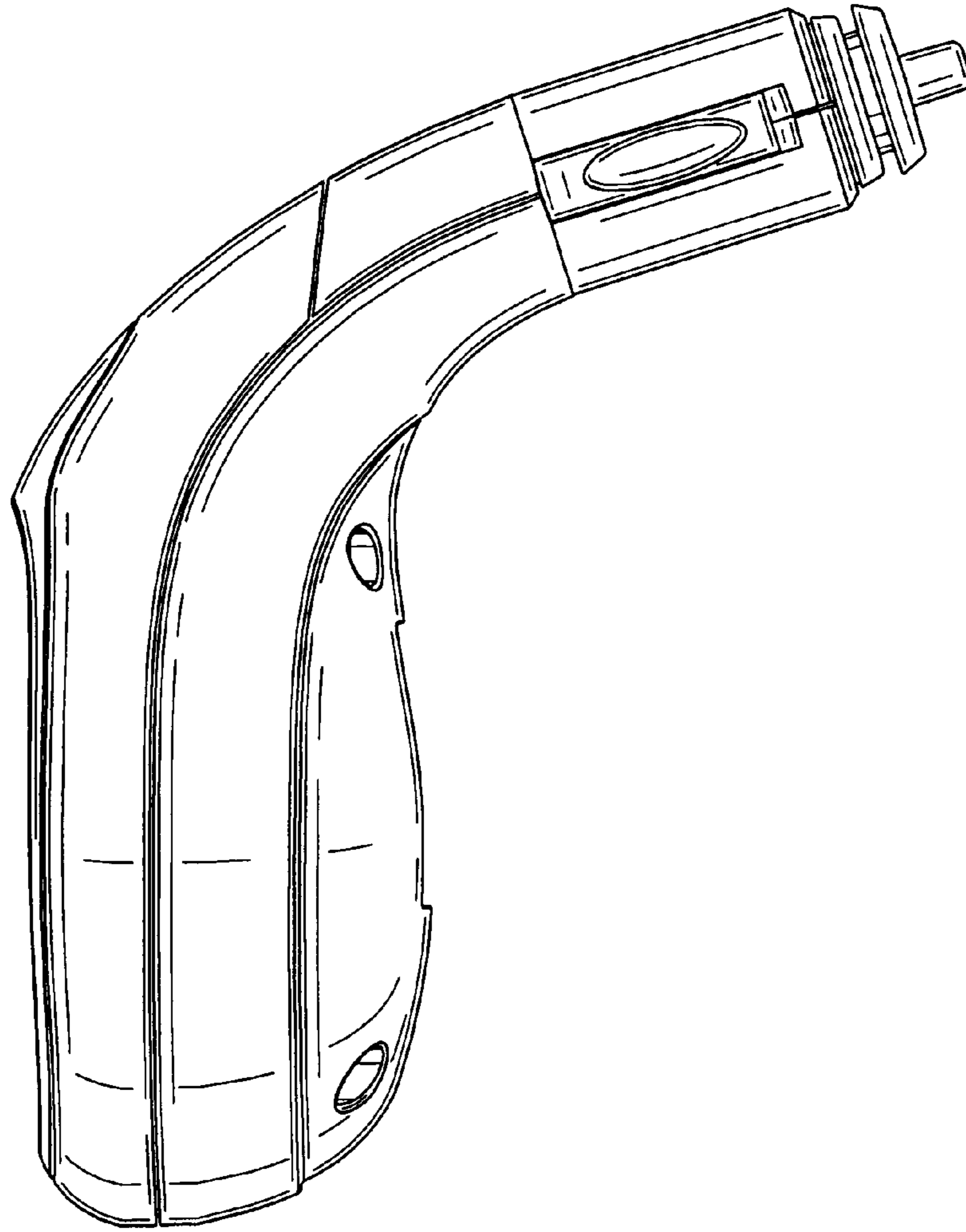

FIG. 3

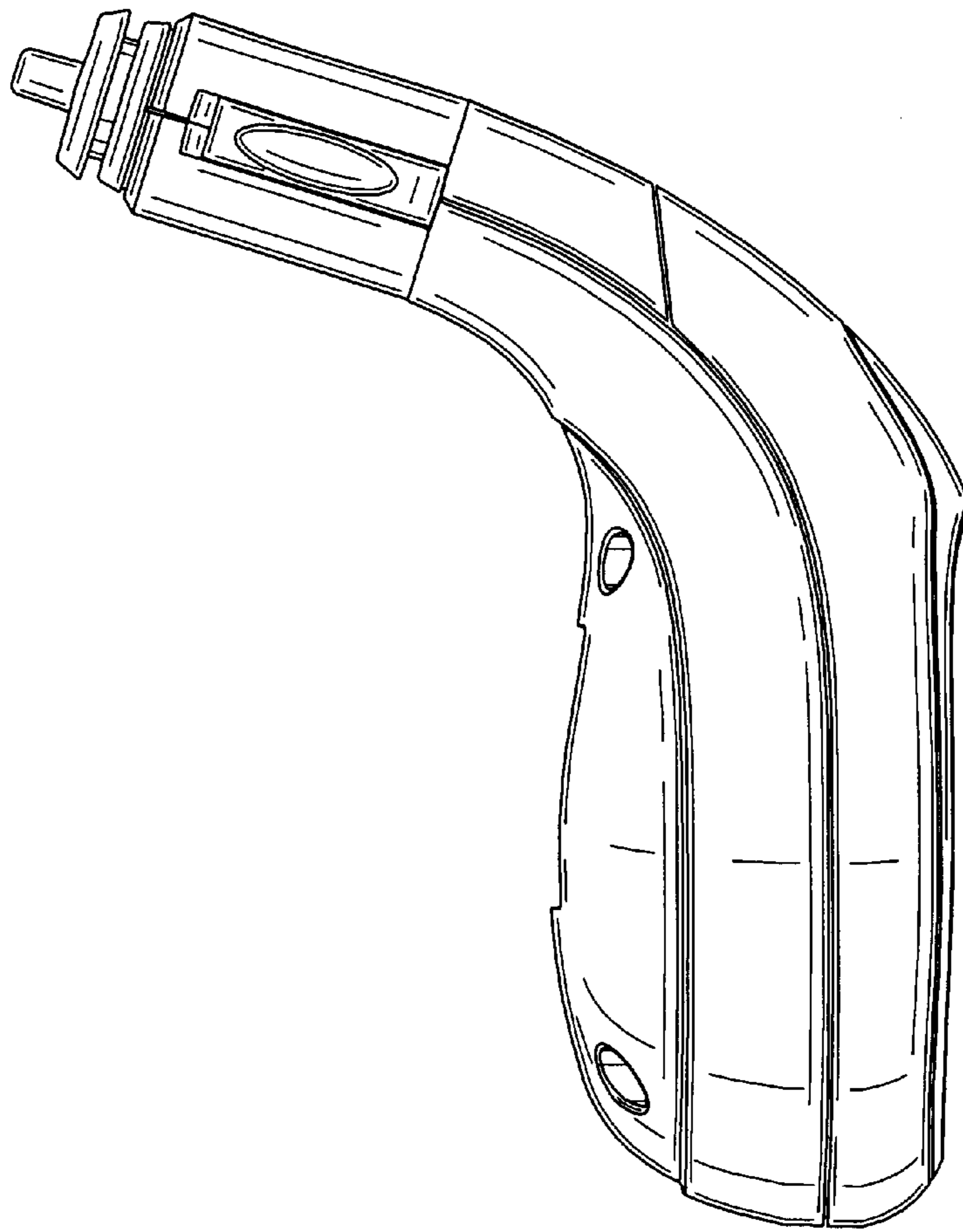

FIG. 4

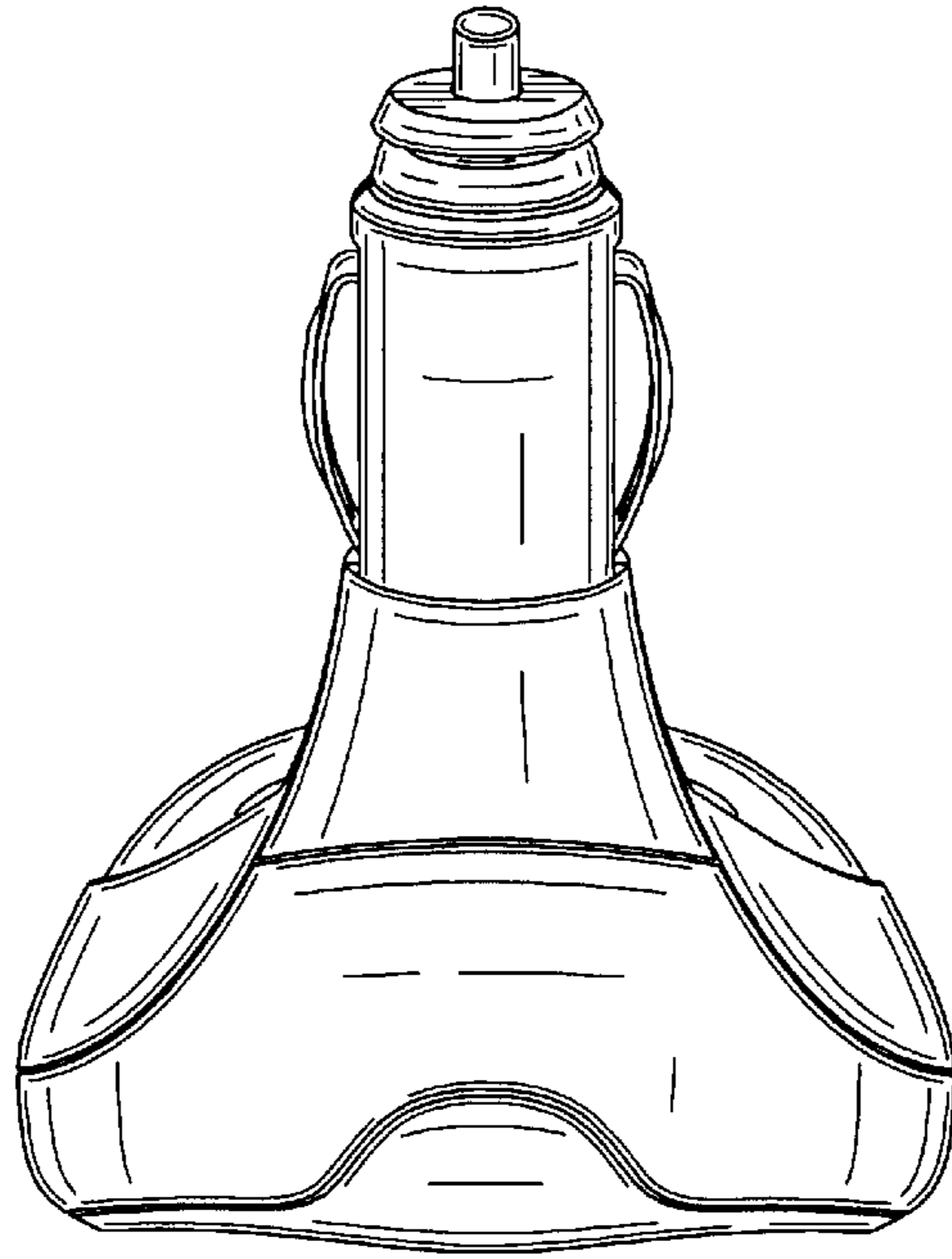

FIG. 5

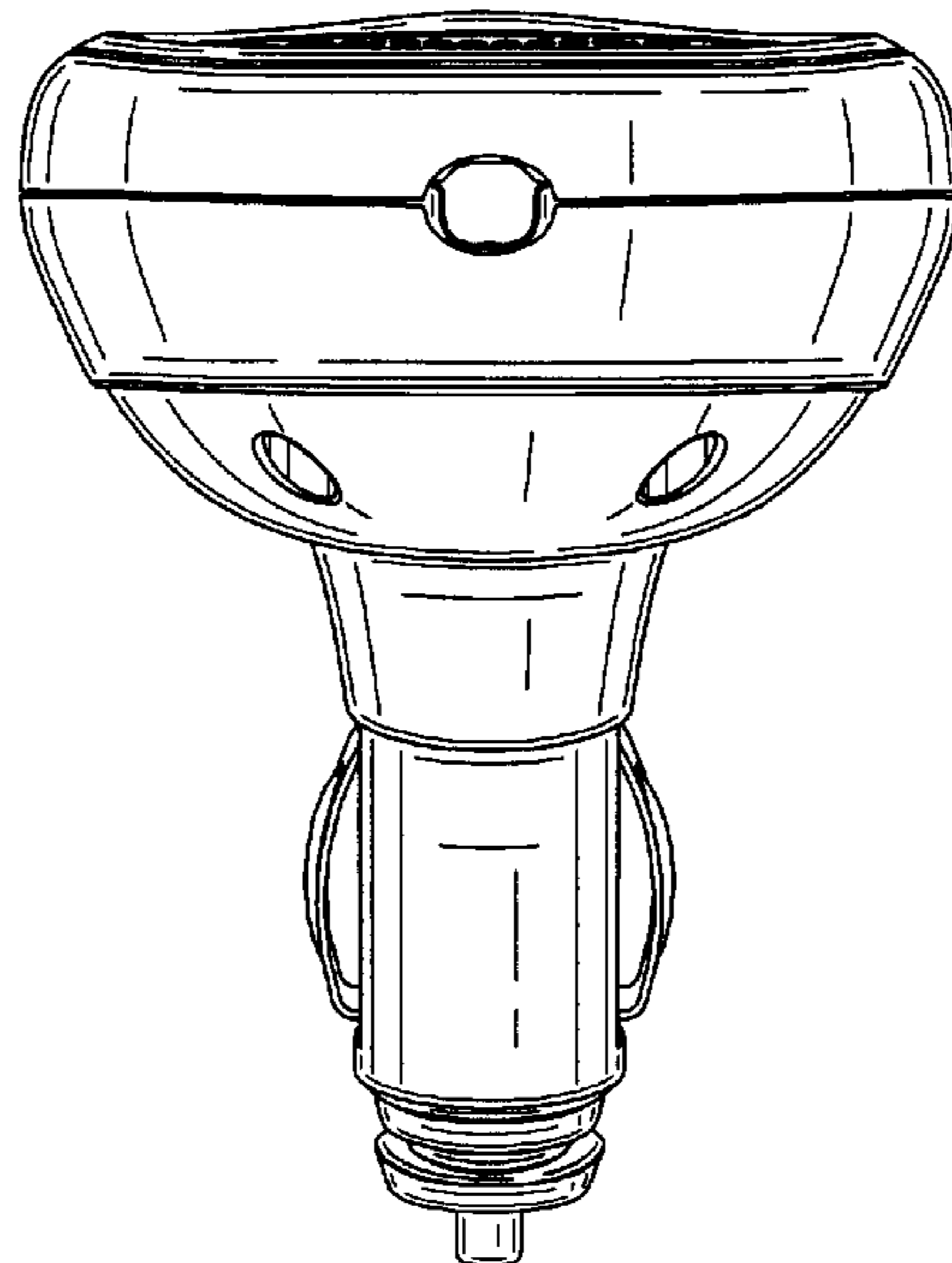

FIG. 6

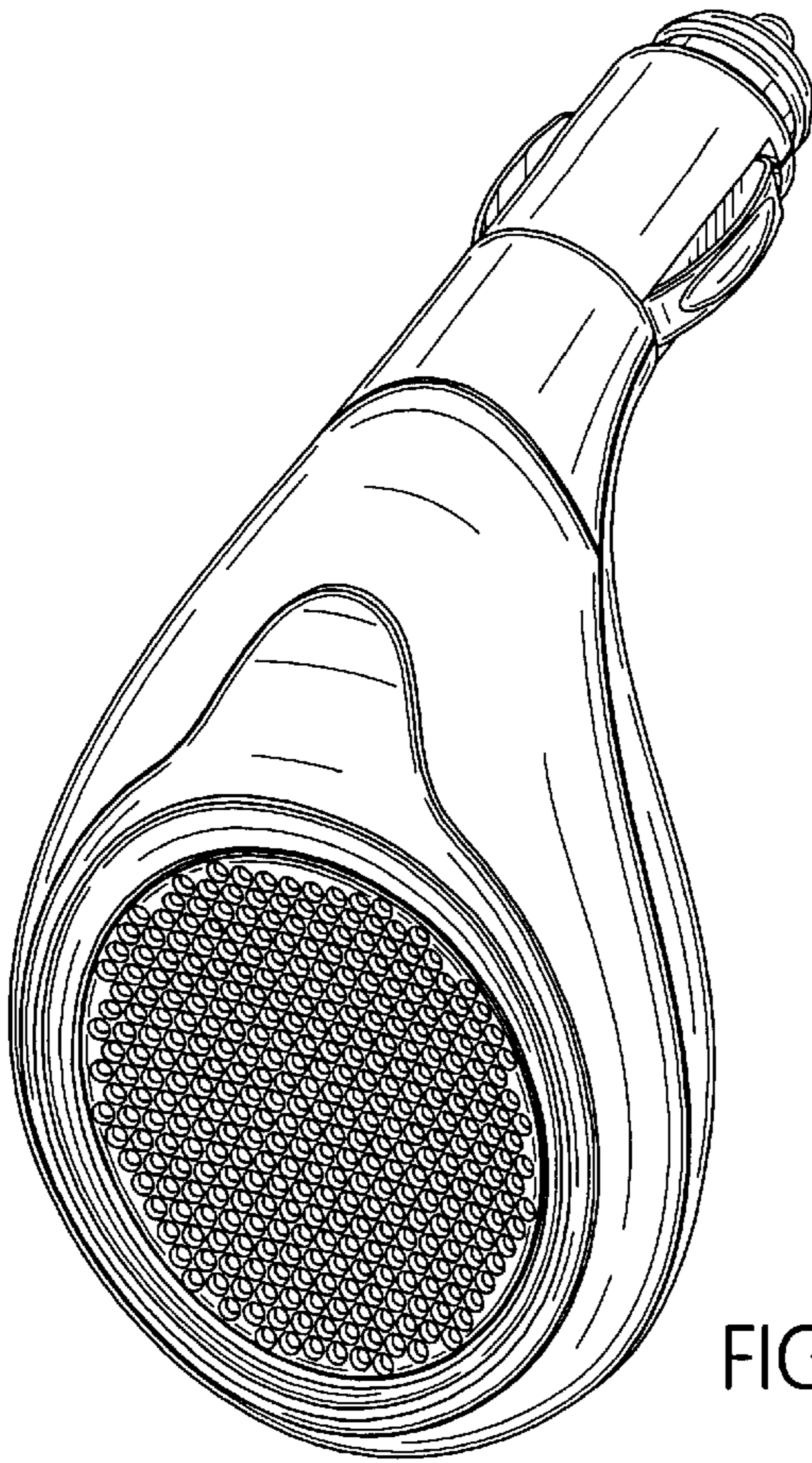

FIG. 7

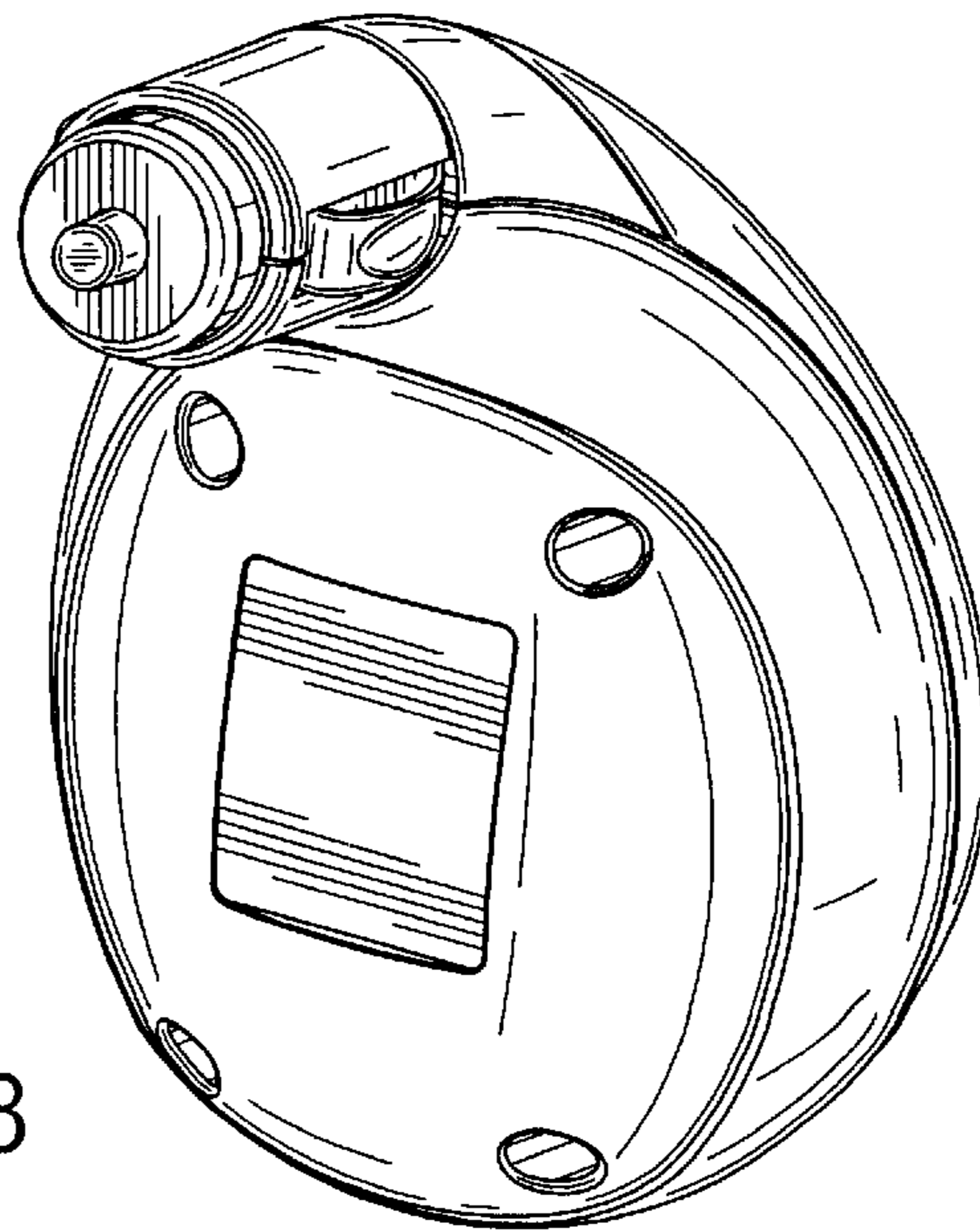

FIG. 8