



US00D519972S

(12) **United States Design Patent** (10) **Patent No.:** **US D519,972 S**
Chung et al. (45) **Date of Patent:** **** May 2, 2006**

(54) **CELLULAR PHONE**

(75) Inventors: **Sung-Mo Chung**, Seoul (KR);
Jong-Seong Lee, Seoul (KR);
Chang-Hwan Hwang, Goyang-si (KR)

(73) Assignee: **Samsung Electronics Co., Ltd.** (KR)

(**) Term: **14 Years**

(21) Appl. No.: **29/221,585**

(22) Filed: **Jan. 17, 2005**

(30) **Foreign Application Priority Data**

Nov. 16, 2004 (KR) 30-2004-0034958

(51) **LOC (8) Cl.** **14-03**

(52) **U.S. Cl.** **D14/138**

(58) **Field of Classification Search** D14/137,
D14/138, 147-148, 247-248, 144, 341-347;
379/433.01-433.13, 434; D21/517; 455/575.3,
455/566, 575.1; 345/169

See application file for complete search history.

(56) **References Cited**

U.S. PATENT DOCUMENTS

D395,300 S * 6/1998 Yamazaki et al. D14/138
D407,716 S * 4/1999 Park D14/138
D419,990 S * 2/2000 Park D14/138
6,549,789 B1 * 4/2003 Kfoury 455/550.1
D488,453 S * 4/2004 Chang et al. D14/138
6,731,959 B1 * 5/2004 Kumagai et al. 455/575.3
6,748,242 B1 * 6/2004 Dunleavy 455/566
D496,020 S * 9/2004 Lee D14/138
D496,021 S * 9/2004 Jang D14/138
D498,468 S * 11/2004 Seo D14/138
D500,994 S * 1/2005 Lee et al. D14/138
D501,839 S * 2/2005 Lee et al. D14/138
D502,161 S * 2/2005 Kim et al. D14/138
D502,459 S * 3/2005 Lee et al. D14/138
D503,697 S * 4/2005 Kim D14/138
D506,454 S * 6/2005 Kim et al. D14/138
D508,035 S * 8/2005 Kim et al. D14/138
D508,036 S * 8/2005 Wada D14/138

D508,475 S * 8/2005 Wu et al. D14/138
D508,684 S * 8/2005 Lee et al. D14/138
D508,903 S * 8/2005 Kim et al. D14/138
2002/0051060 A1 * 5/2002 Wada 348/207
2003/0064758 A1 * 4/2003 Mizuta et al. 455/566
2003/0078069 A1 * 4/2003 Lindeman 455/550
2003/0228847 A1 * 12/2003 Matsumoto 455/90.3
2004/0132482 A1 * 7/2004 Kang et al. 455/550.1
2004/0192220 A1 * 9/2004 Huang et al. 455/74
2004/0192422 A1 * 9/2004 Watanabe et al. 455/575.3
2004/0198474 A1 * 10/2004 Jung et al. 455/575.1
2004/0203535 A1 * 10/2004 Kim et al. 455/90.3
2004/0224730 A1 * 11/2004 Sakai et al. 455/575.3
2005/0078211 A1 * 4/2005 Whitehorn et al. 348/376
2005/0104955 A1 * 5/2005 Navntoft 348/14.02
2005/0113156 A1 * 5/2005 Park et al. 455/575.4
2005/0130718 A1 * 6/2005 Woo 455/575.3
2005/0140778 A1 * 6/2005 Kim et al. 348/14.02
2005/0186985 A1 * 8/2005 Im et al. 455/550.1

FOREIGN PATENT DOCUMENTS

JP 1143093 * 6/2002
JP 1159728 * 12/2002

* cited by examiner

Primary Examiner—Jeffrey Asch

(74) *Attorney, Agent, or Firm*—Cantor Colburn LLP

(57) **CLAIM**

We claim, the ornamental design for a cellular phone, as shown and described.

DESCRIPTION

FIG. 1 is a top and front perspective view of a cellular phone, showing our new design;
FIG. 2 is a front elevational view thereof;
FIG. 3 is a rear elevational view thereof;
FIG. 4 is a left side elevational view thereof;
FIG. 5 is a right side elevational view thereof;
FIG. 6 is a top elevational view thereof;
FIG. 7 is a bottom elevational view thereof; and,
FIG. 8 is a front perspective view thereof, the cellular phone being in an alternate position.

1 Claim, 4 Drawing Sheets

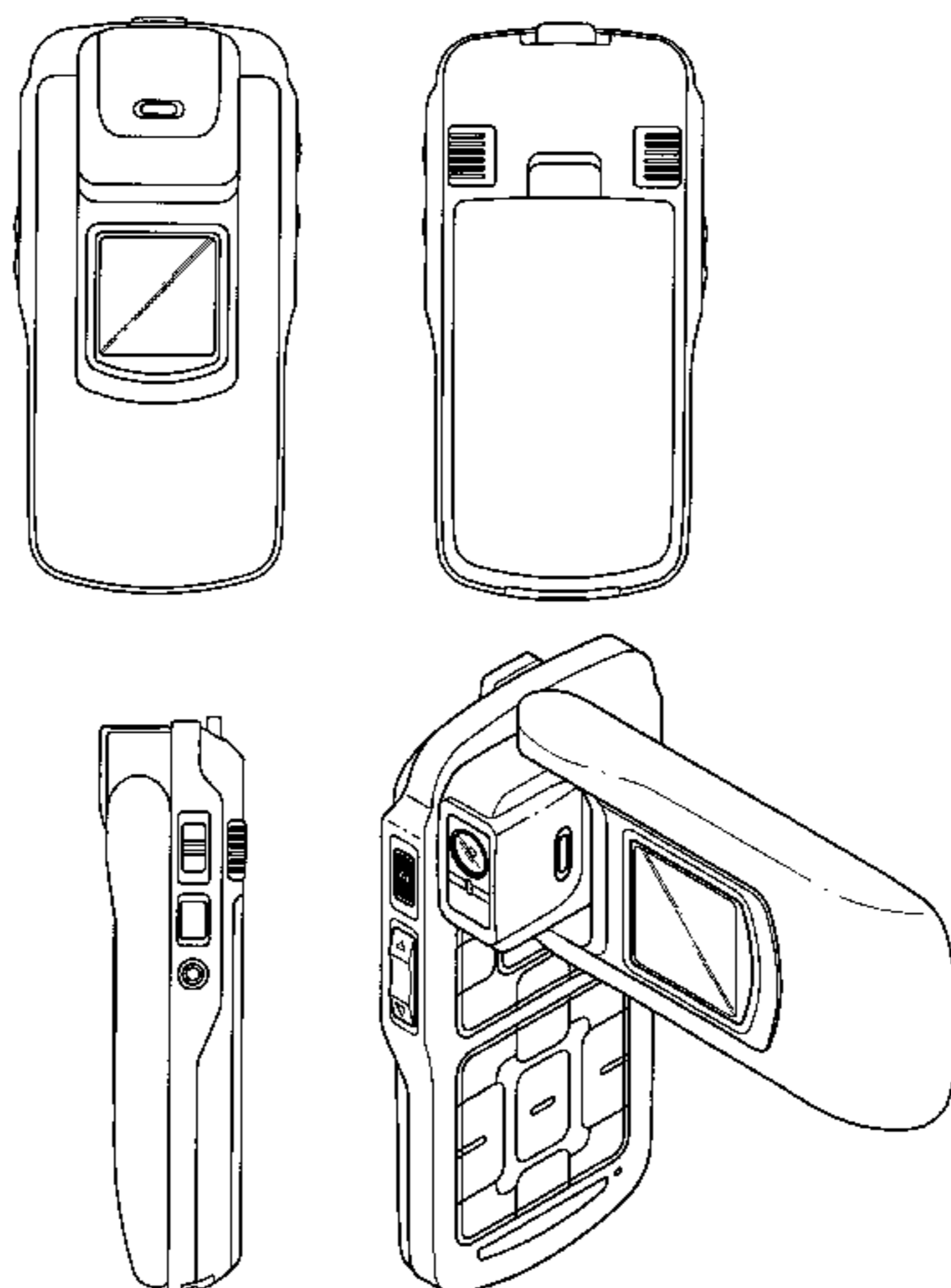

FIG. 1

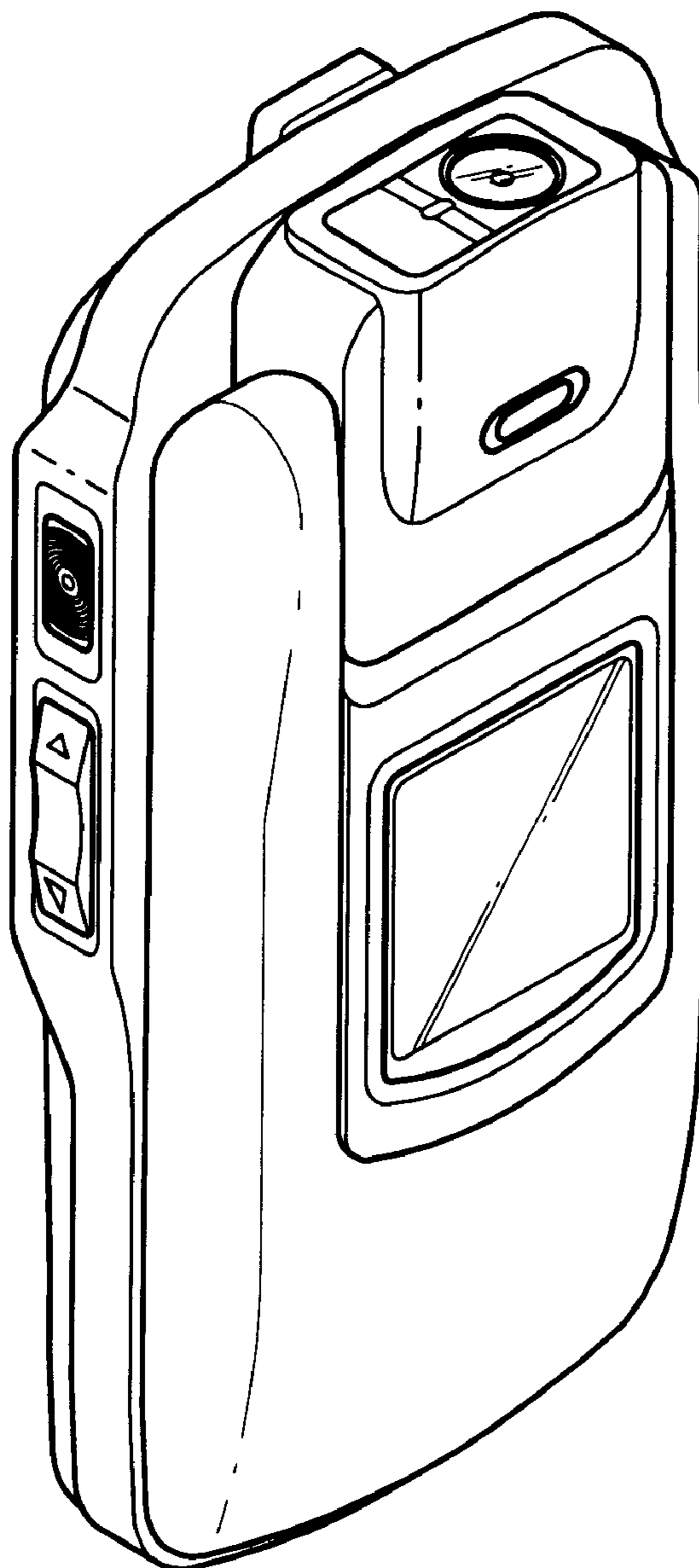

FIG. 2

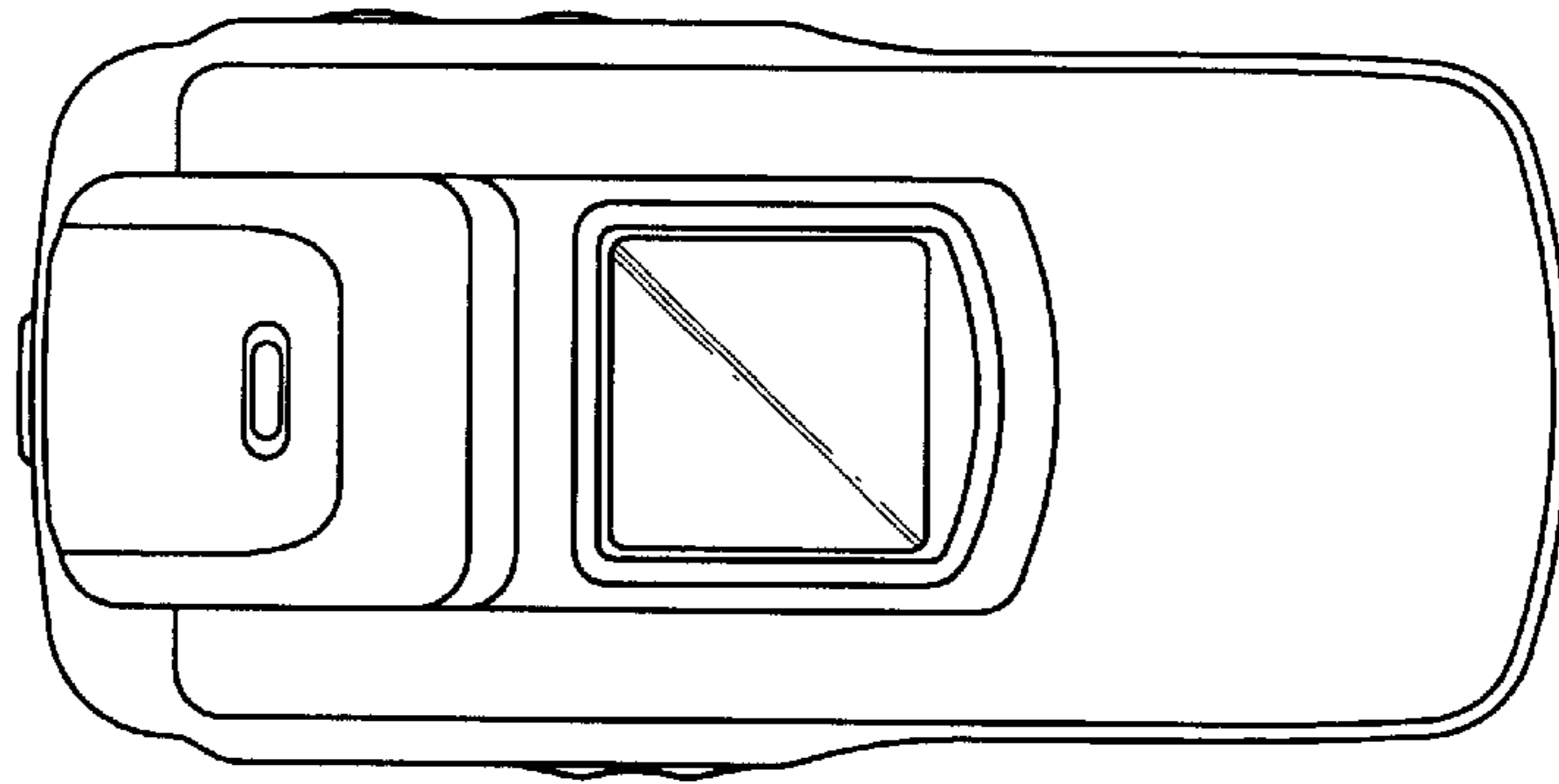

FIG. 3

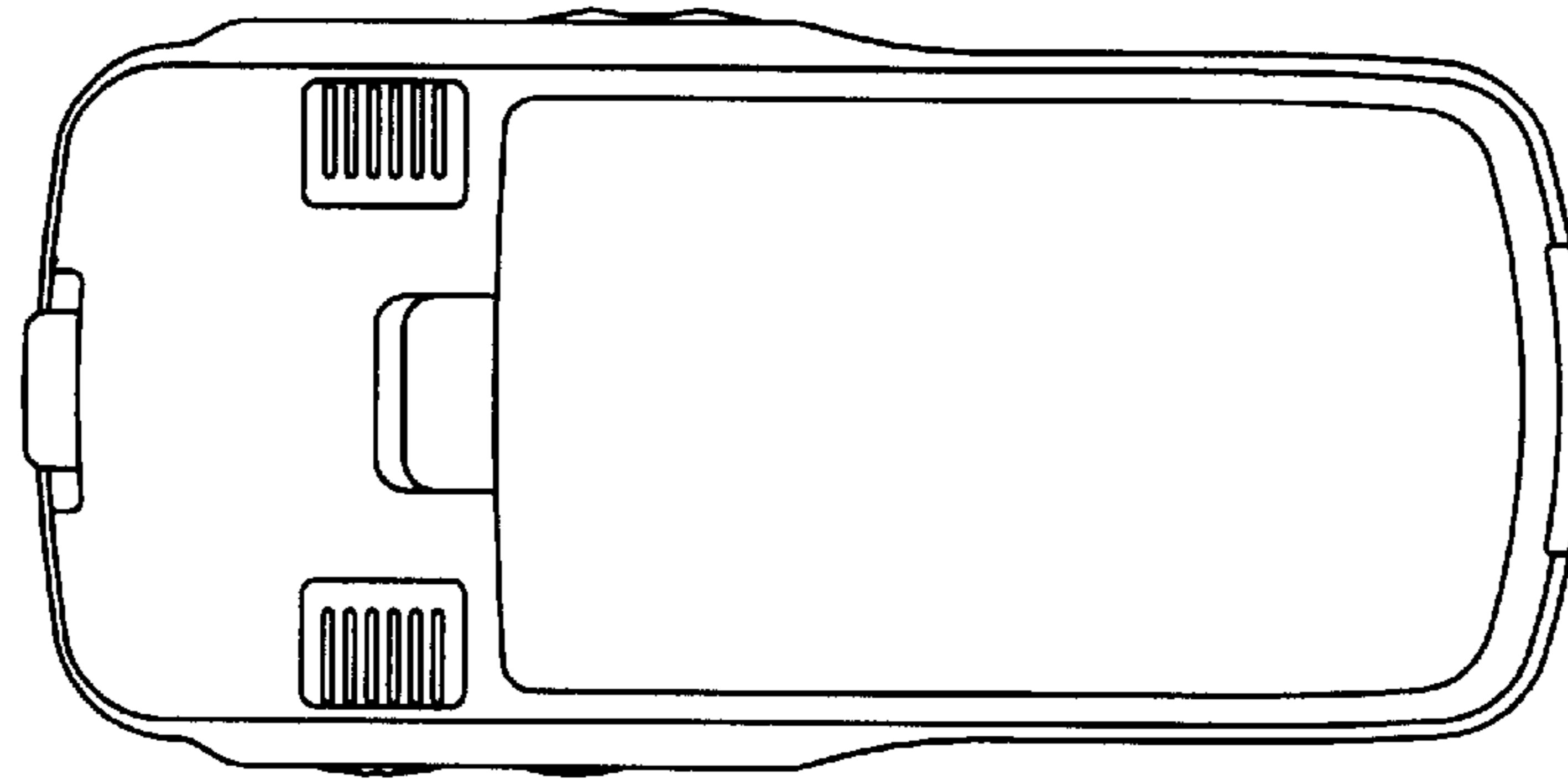

FIG. 4

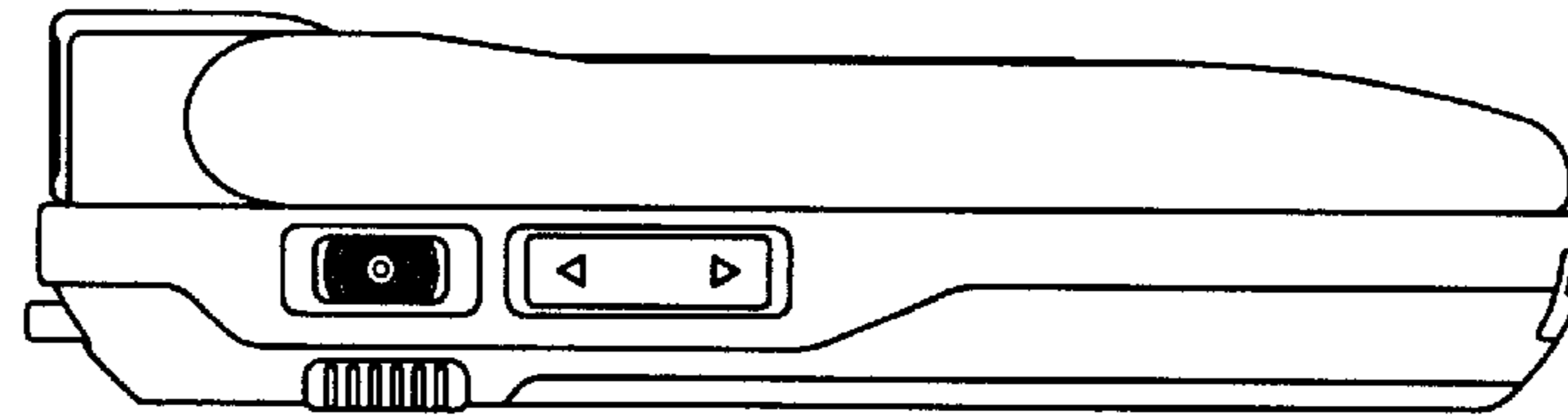

FIG. 5

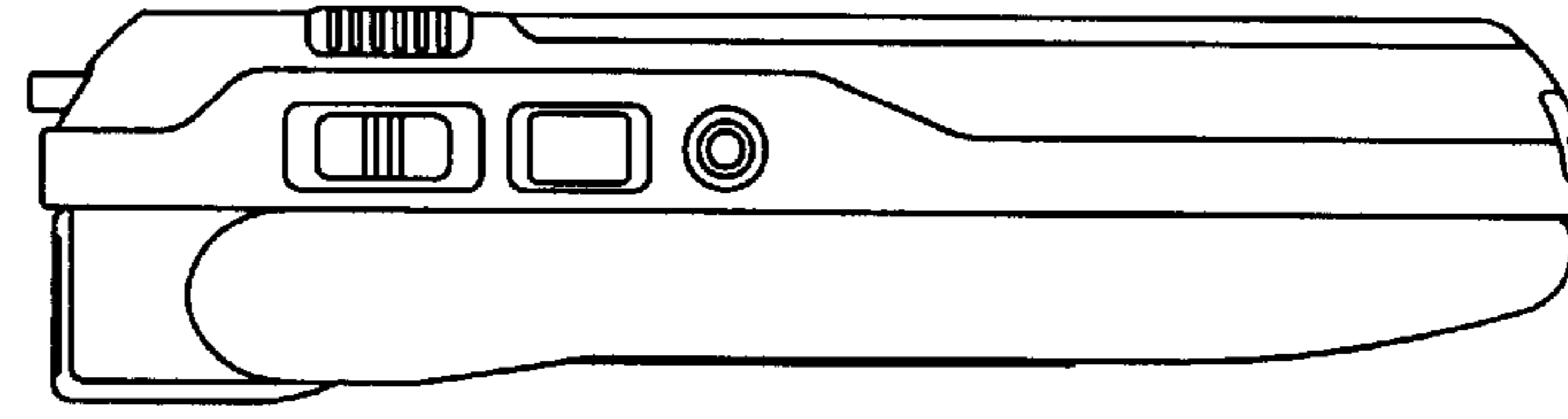

FIG. 6

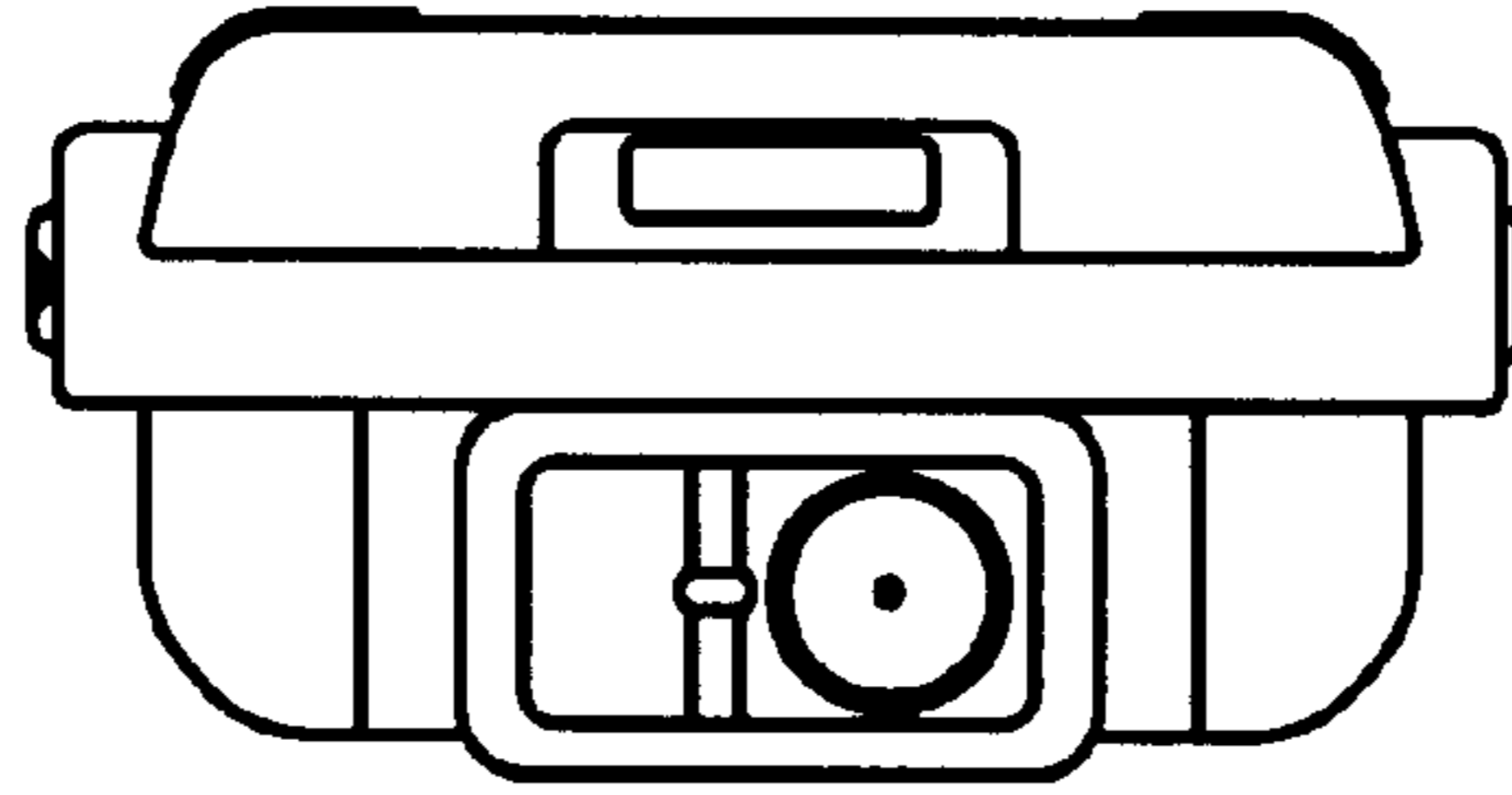

FIG. 7

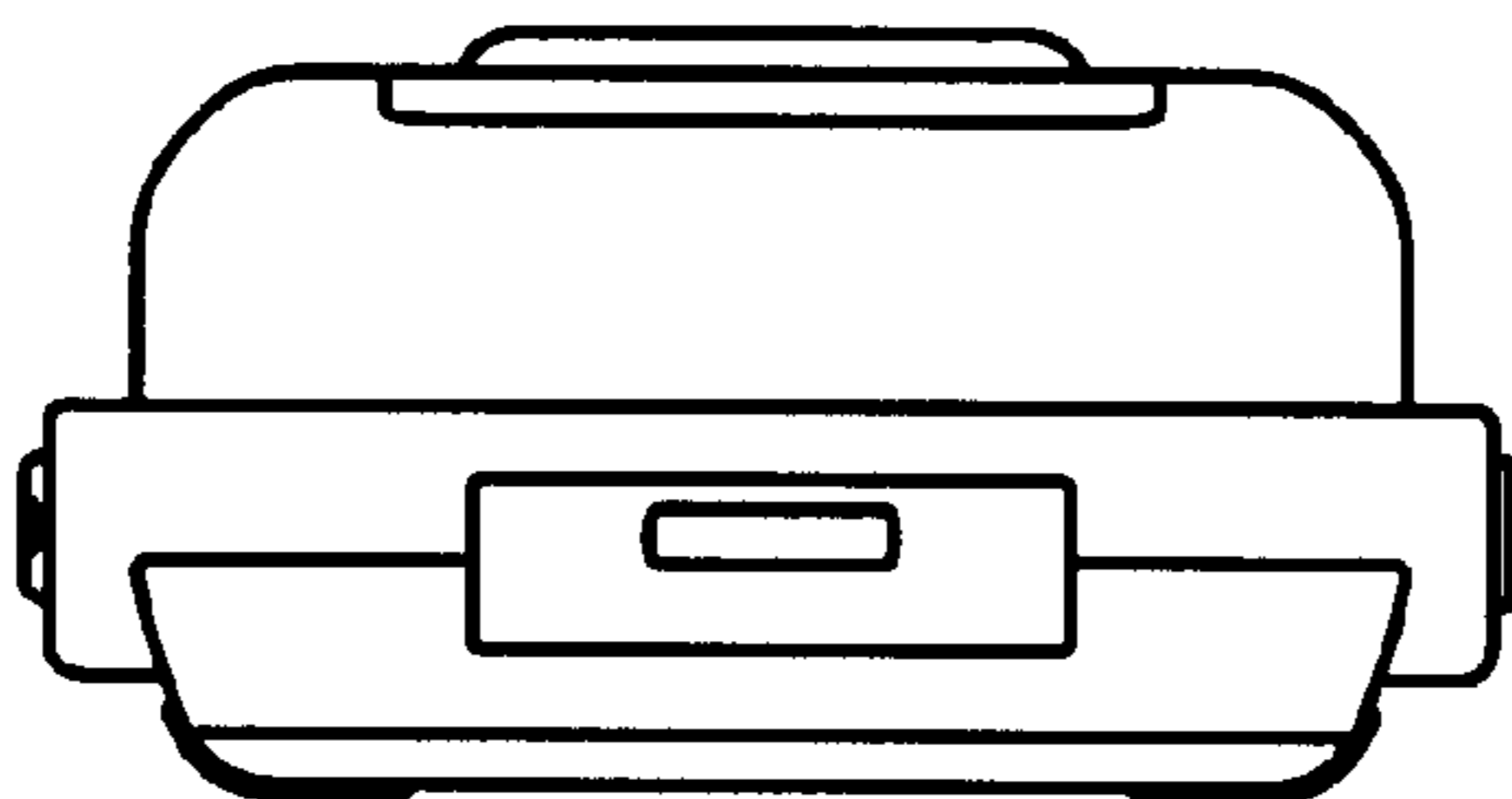

FIG. 8

