



US00D519947S

(12) **United States Design Patent**
Lin

(10) **Patent No.:** **US D519,947 S**

(45) **Date of Patent:** **** May 2, 2006**

(54) **TELEVISION SET**

(75) Inventor: **Roger Lin**, Taipei (TW)

(73) Assignee: **Hannspree, Inc.**, Taipei (TW)

(**) Term: **14 Years**

(21) Appl. No.: **29/227,504**

(22) Filed: **Apr. 13, 2005**

(30) **Foreign Application Priority Data**

Nov. 9, 2004 (TW) 93306636

(51) **LOC (8) Cl.** **14-03**

(52) **U.S. Cl.** **D14/126; D14/129**

(58) **Field of Classification Search** D14/125-134,
D14/239, 371, 136, 374-376; 312/7.2; 348/836,
348/838, 180, 184, 325, 739; 341/12; 248/917-924,
248/465; 345/104, 133, 156, 168, 87, 173;
720/605, 669, 600, 655; 369/99, 197; 455/344-347
See application file for complete search history.

(56) **References Cited**

U.S. PATENT DOCUMENTS

5,072,998 A * 12/1991 Oh 312/7.2
D323,324 S * 1/1992 Suda D14/125
5,464,214 A * 11/1995 Griffin 273/148 B
5,564,209 A * 10/1996 Zagnoli 312/7.2

5,825,347 A * 10/1998 Prinsen 348/836
D406,613 S * 3/1999 Nakanishi D21/329
6,159,101 A * 12/2000 Simpson 463/46
D438,849 S * 3/2001 Adachi et al. D14/126
6,558,225 B1 * 5/2003 Rehkemper et al. 446/297
D475,707 S * 6/2003 Zuege et al. D14/371
D500,099 S * 12/2004 Gioffre D21/627
D508,695 S * 8/2005 Vaughn D14/448

OTHER PUBLICATIONS

Hong Kong Enterprise, p. 212, Feb. 2000.*

* cited by examiner

Primary Examiner—Raphael Barkai

(74) *Attorney, Agent, or Firm*—Troxell Law Office, PLC

(57) **CLAIM**

The ornamental design for a television set, as shown and described.

DESCRIPTION

FIG. 1 is a front e view of television set showing my design;
FIG. 2 is a right side view thereof;
FIG. 3 is a top view thereof;
FIG. 4 is a rear view thereof;
FIG. 5 is a left side view thereof; and,
FIG. 6 is a perspective view thereof.

1 Claim, 3 Drawing Sheets

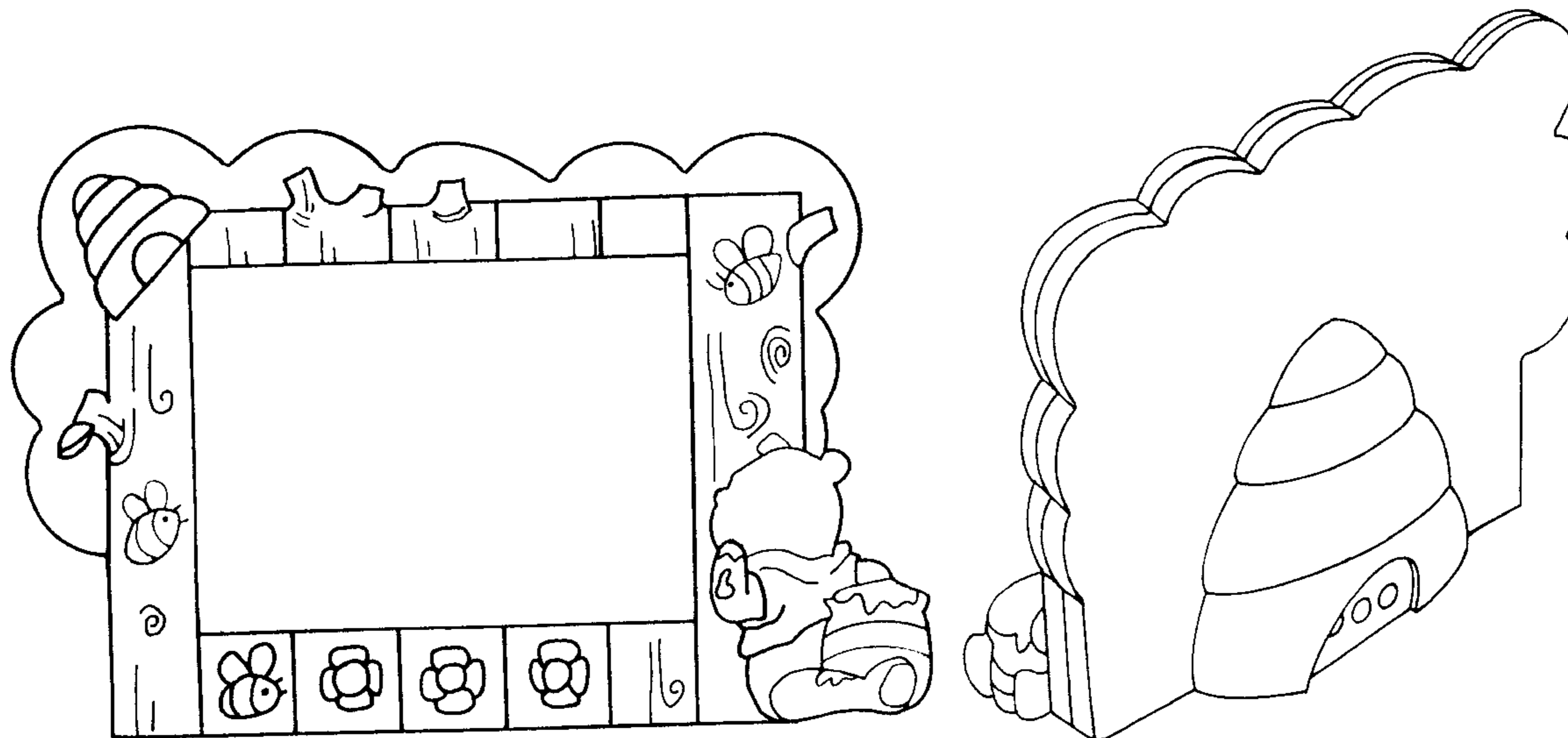

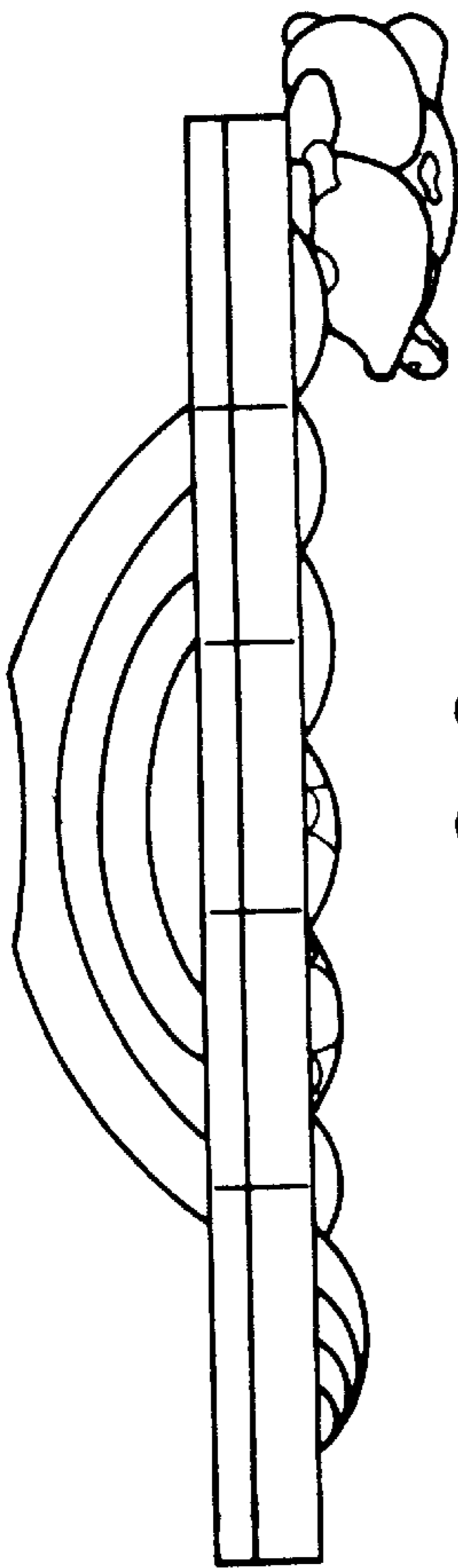

FIG. 3

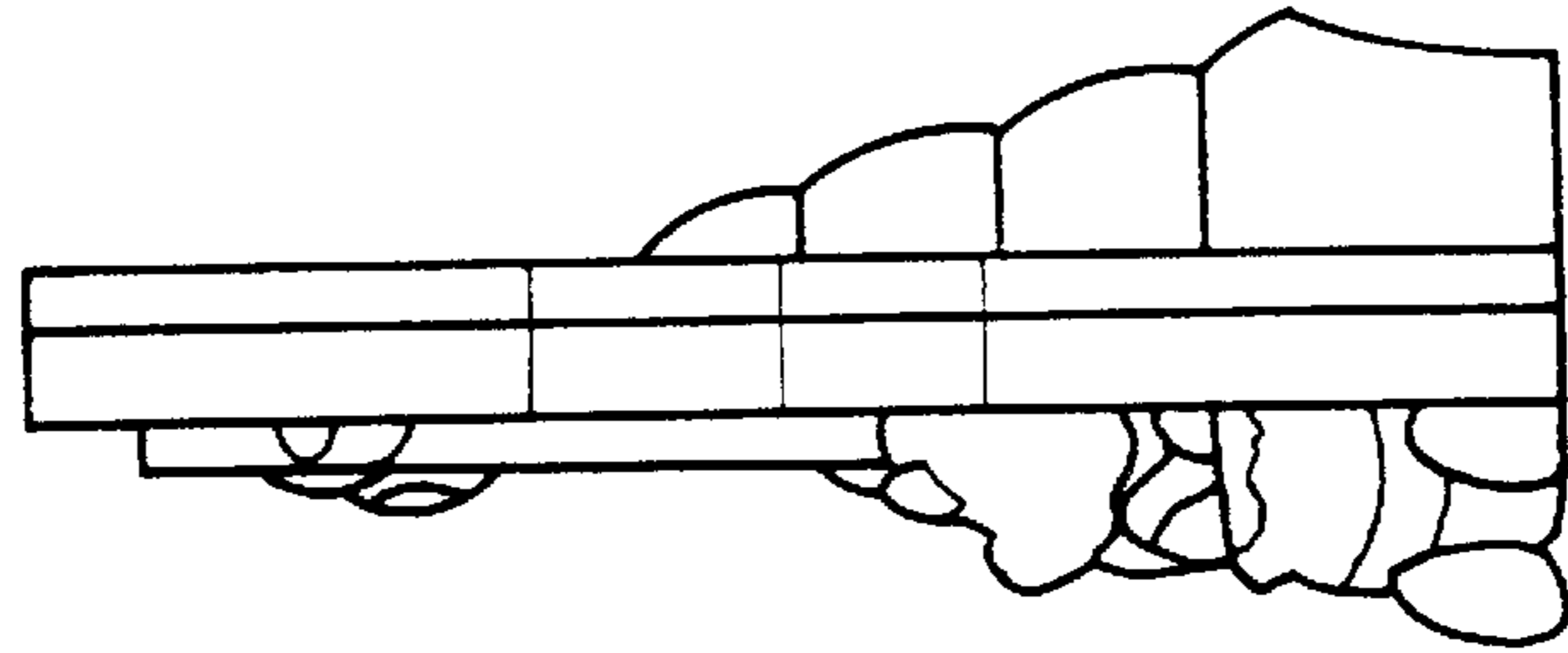

FIG. 2

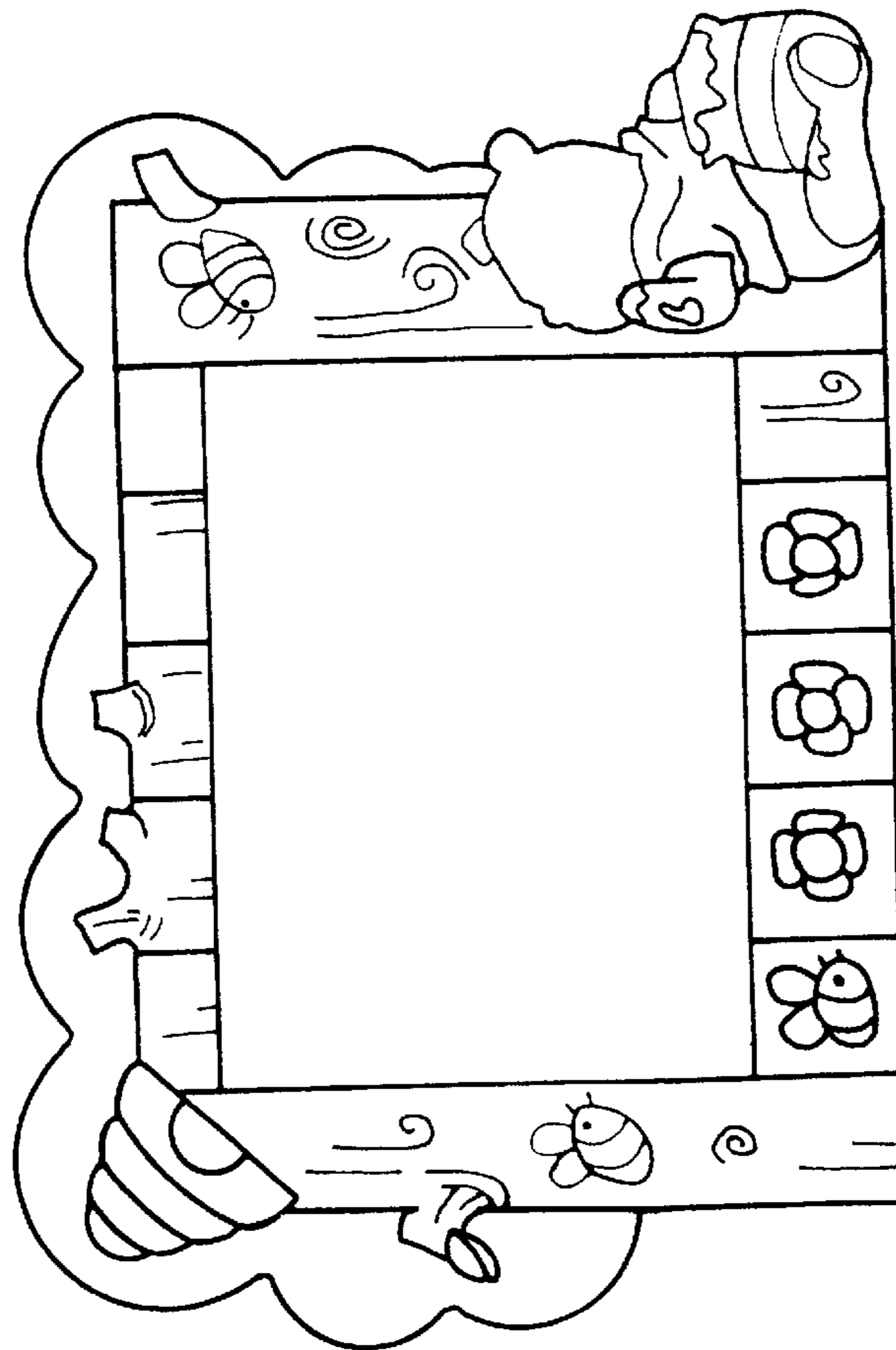

FIG. 1

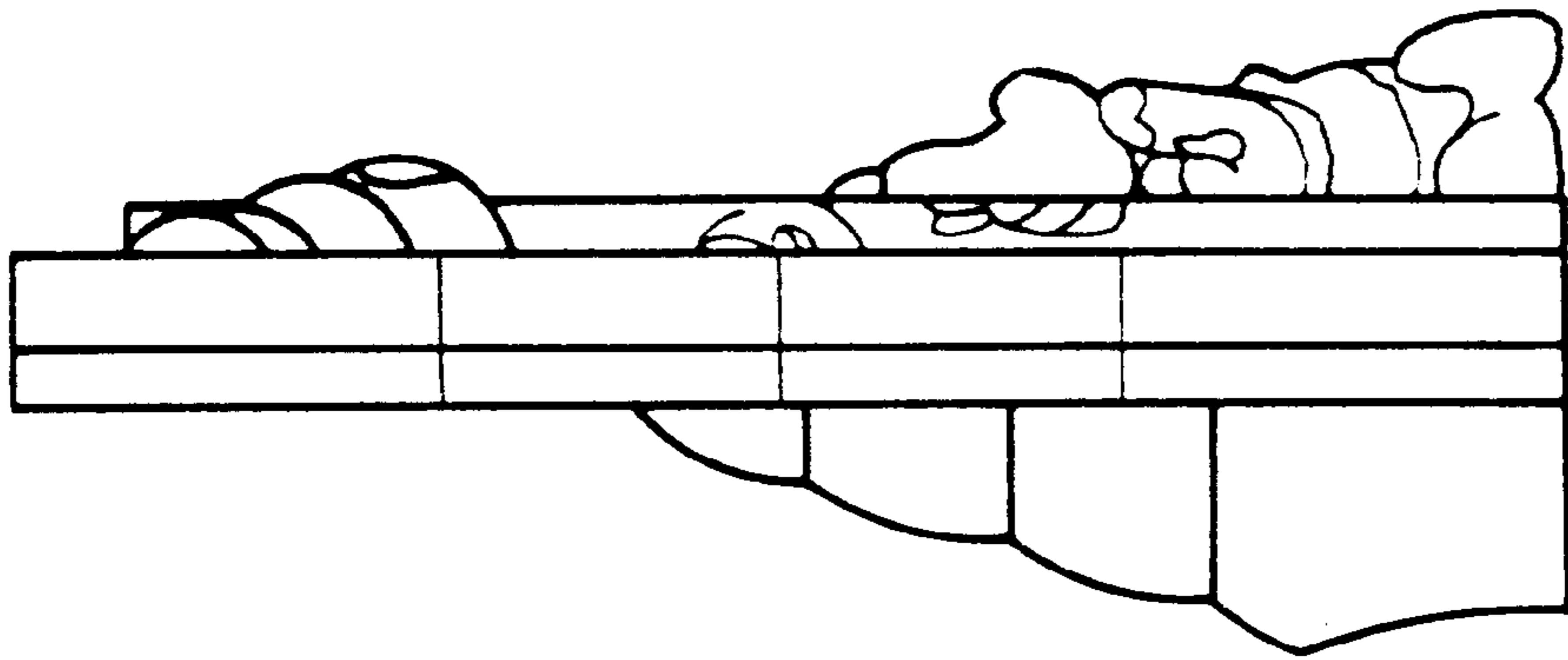

FIG. 5

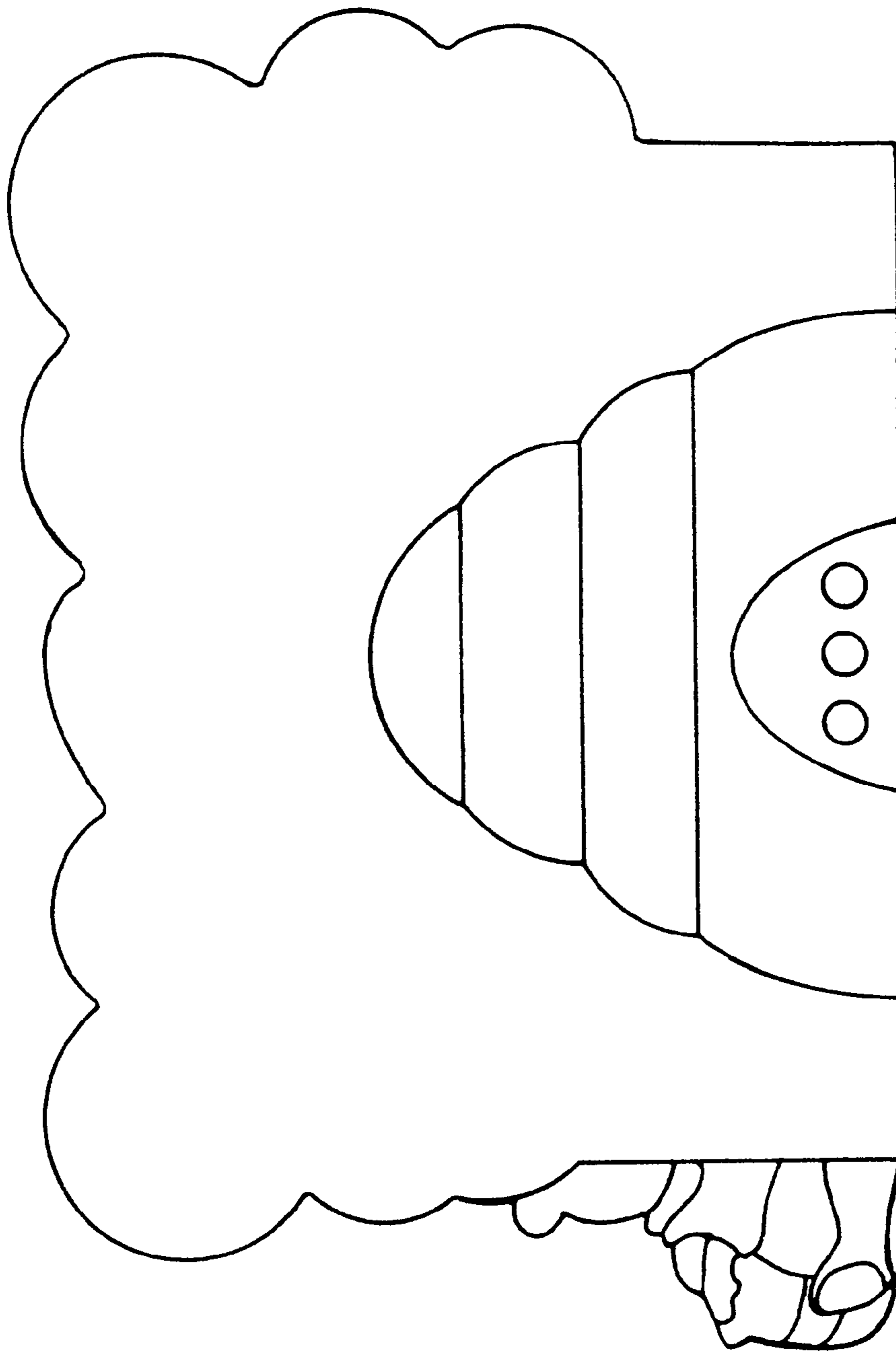

FIG. 4

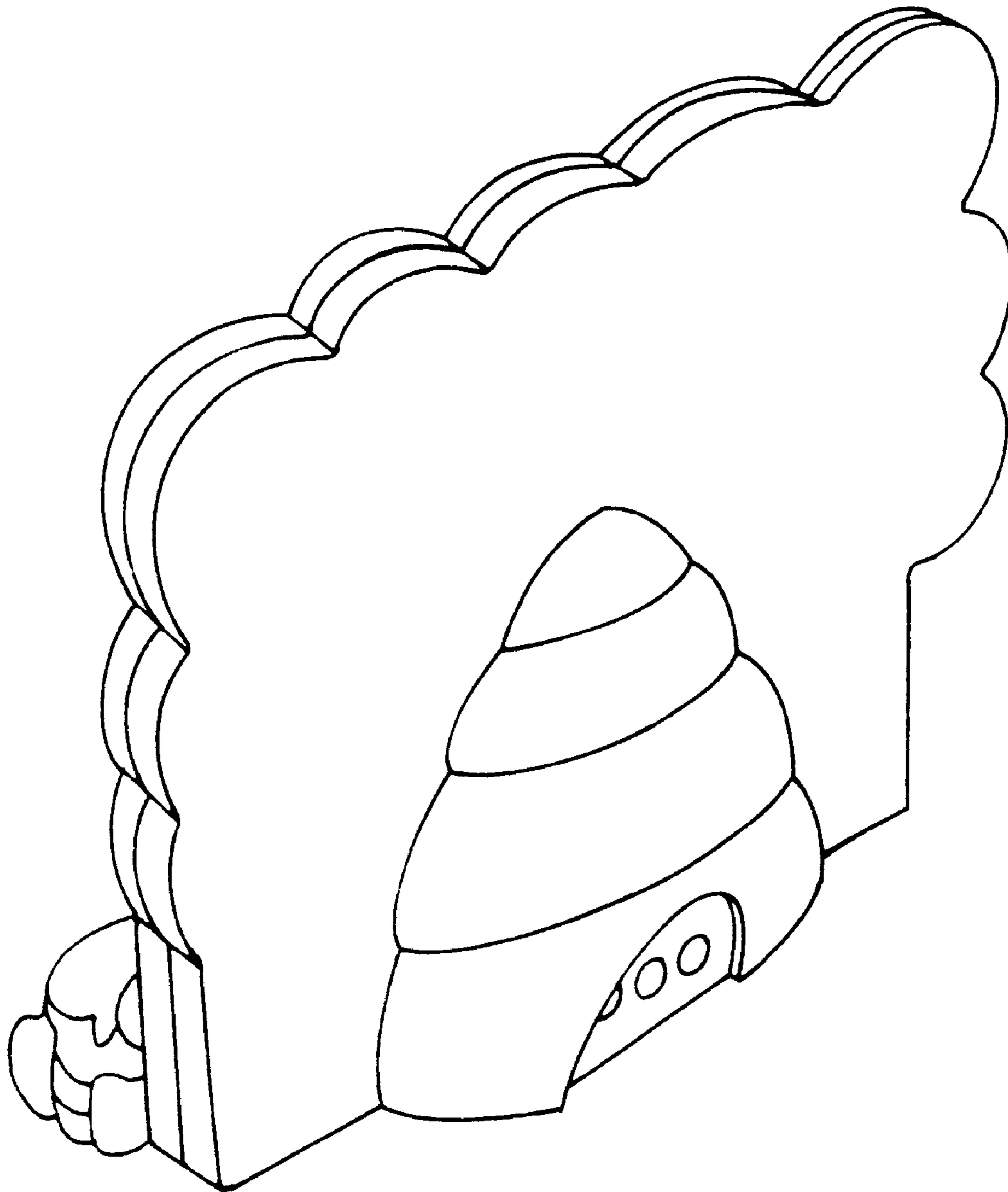

FIG. 6