



US00D519512S

(12) **United States Design Patent** (10) **Patent No.:** **US D519,512 S**
Nishio et al. (45) **Date of Patent:** **** Apr. 25, 2006**

(54) **CONNECTOR FOR DATA CONVERSION**

(75) Inventors: **Atsushi Nishio**, Tama (JP); **Yoshinori Ohta**, Tama (JP); **Masaaki Hayashi**, Tama (JP)

(73) Assignee: **Mitsumi Electric Co., Ltd.**, Tokyo (JP)

(**) Term: **14 Years**

(21) Appl. No.: **29/223,250**

(22) Filed: **Feb. 14, 2005**

(30) **Foreign Application Priority Data**

Nov. 15, 2004 (JP) 2004-034786

(51) **LOC (8) Cl.** **14-02**

(52) **U.S. Cl.** **D14/433; D13/147**

(58) **Field of Classification Search** 439/367, 439/352, 620, 247, 248, 263, 378, 37, 701, 439/76.1, 541.5, 74; D14/433, 435, 356, D14/357, 432; D13/147; 174/65 R; 361/601, 361/686, 730, 752, 796; 333/25, 24 R, 32, 333/33; 335/202

See application file for complete search history.

(56) **References Cited**

U.S. PATENT DOCUMENTS

- 4,558,914 A * 12/1985 Prager et al. 439/259
- D290,705 S * 7/1987 Yomo D14/435
- 4,978,313 A * 12/1990 Kameyama et al. 439/248
- D331,573 S * 12/1992 Iino D14/434
- D339,105 S * 9/1993 Manaka et al. D13/120
- 5,263,875 A * 11/1993 Spicer et al. 439/367

- 5,276,418 A * 1/1994 Klosowiak et al. 335/202
- D363,918 S * 11/1995 Buongervino et al. D13/147
- 5,863,211 A * 1/1999 Sobotta et al. 439/74
- D421,968 S * 3/2000 Matsumura D13/182
- 6,050,849 A * 4/2000 Chang 439/536
- D426,522 S * 6/2000 Matsumura D13/182
- D463,414 S * 9/2002 Gao D14/240
- D474,449 S * 5/2003 Rosander D13/147
- D476,977 S * 7/2003 Gao et al. D14/240
- 6,652,292 B1 * 11/2003 Pratt et al. 439/76.1
- D485,562 S * 1/2004 Goto D14/439
- 6,692,310 B1 * 2/2004 Zaderej et al. 439/701
- D495,299 S * 8/2004 Saito et al. D13/147
- D510,091 S * 9/2005 Mori et al. D14/434

* cited by examiner

Primary Examiner—Alan P. Douglas

Assistant Examiner—Susan Moon Lee

(74) *Attorney, Agent, or Firm*—Sughrue Mion, PLLC

(57) **CLAIM**

The ornamental design for a connector for data conversion, as shown.

DESCRIPTION

FIG. 1 is a perspective view of the front, top, and right side of a connector for data conversion showing our new design; FIG. 2 is a front elevational view thereof; FIG. 3 is a rear elevational view thereof; FIG. 4 is a left side elevational view thereof; FIG. 5 is a right side elevational view thereof; FIG. 6 is a top plan view thereof; and, FIG. 7 is a bottom plan view thereof.

1 Claim, 5 Drawing Sheets

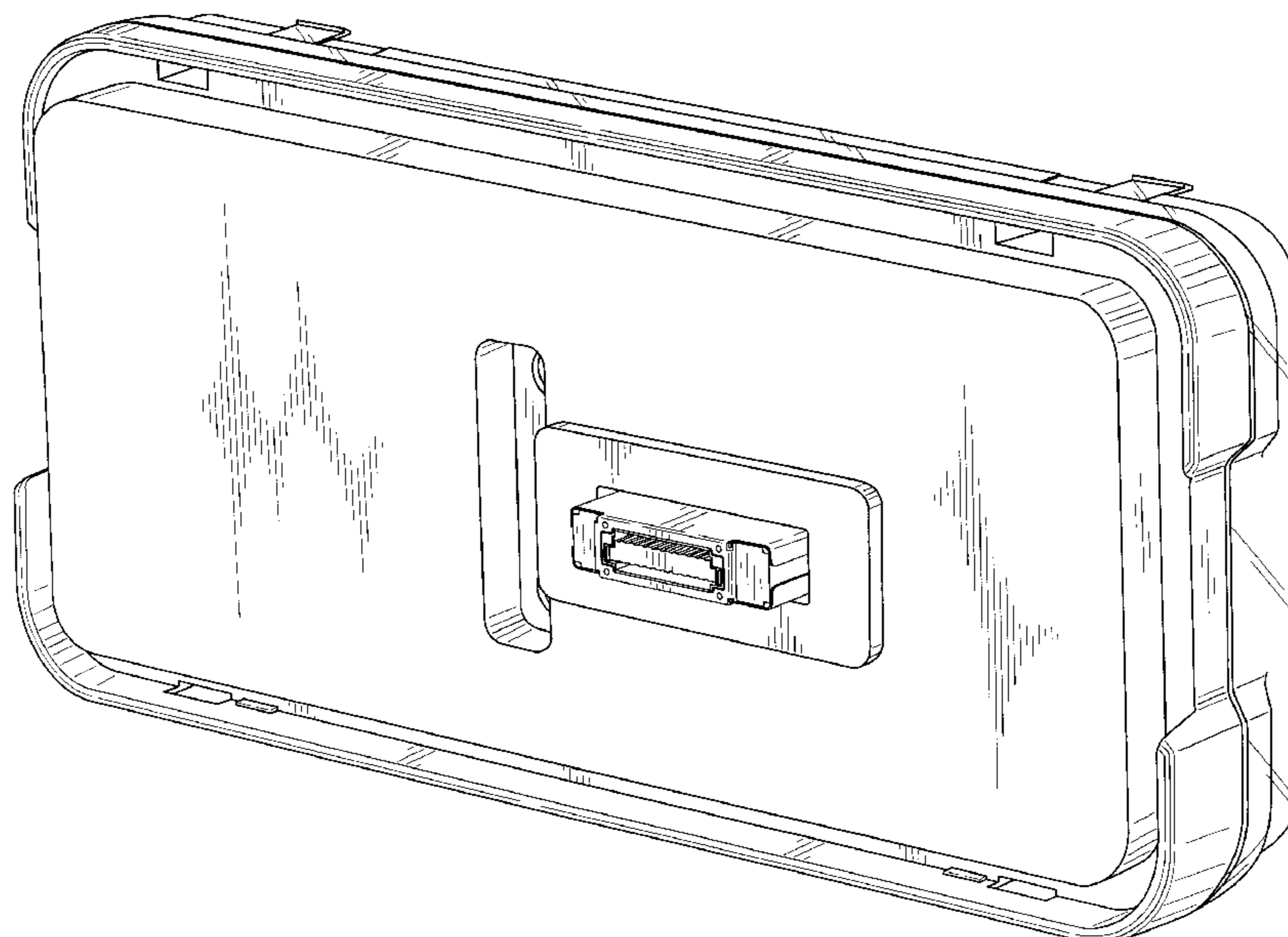

FIG. 1

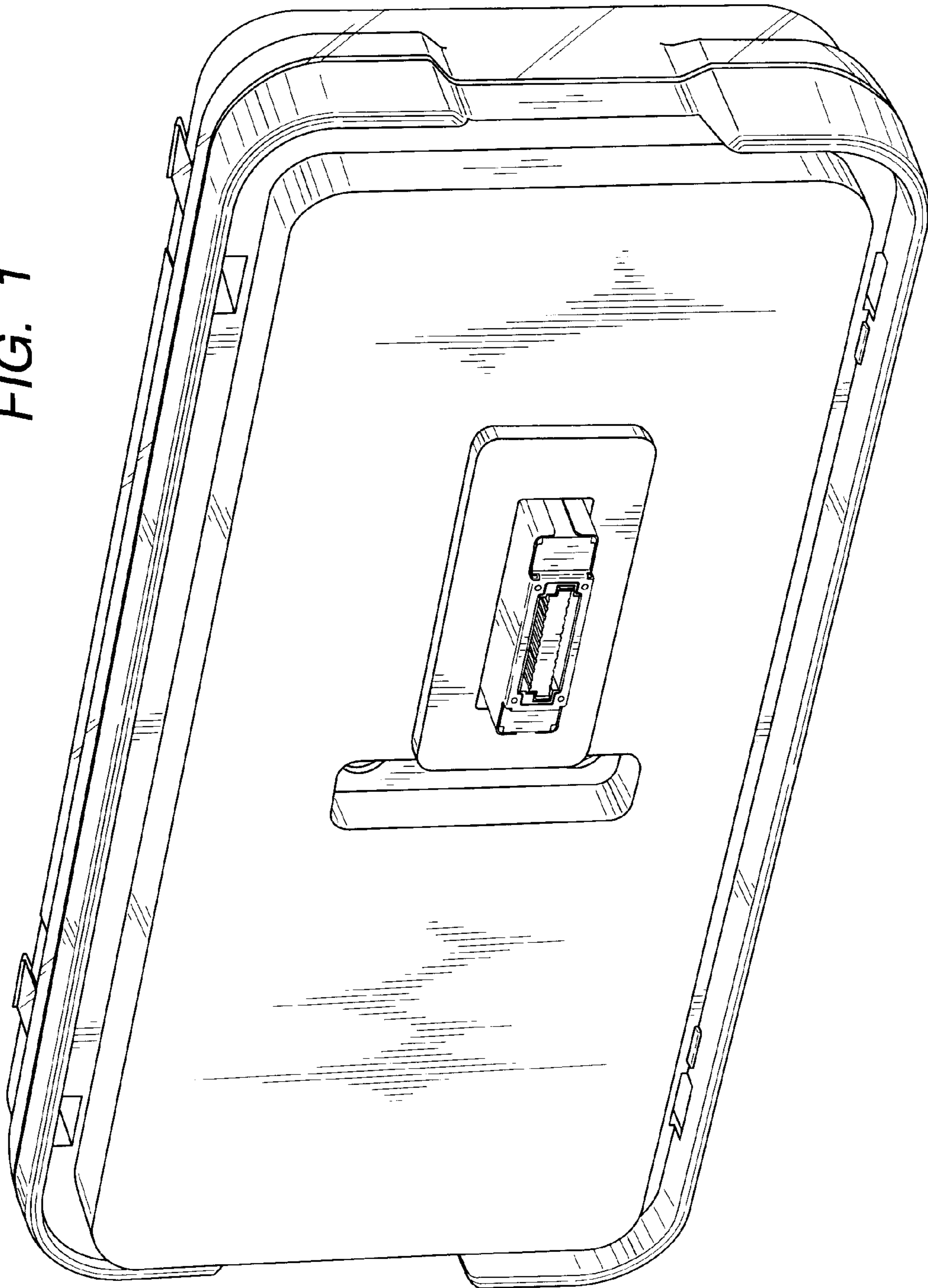

FIG. 2

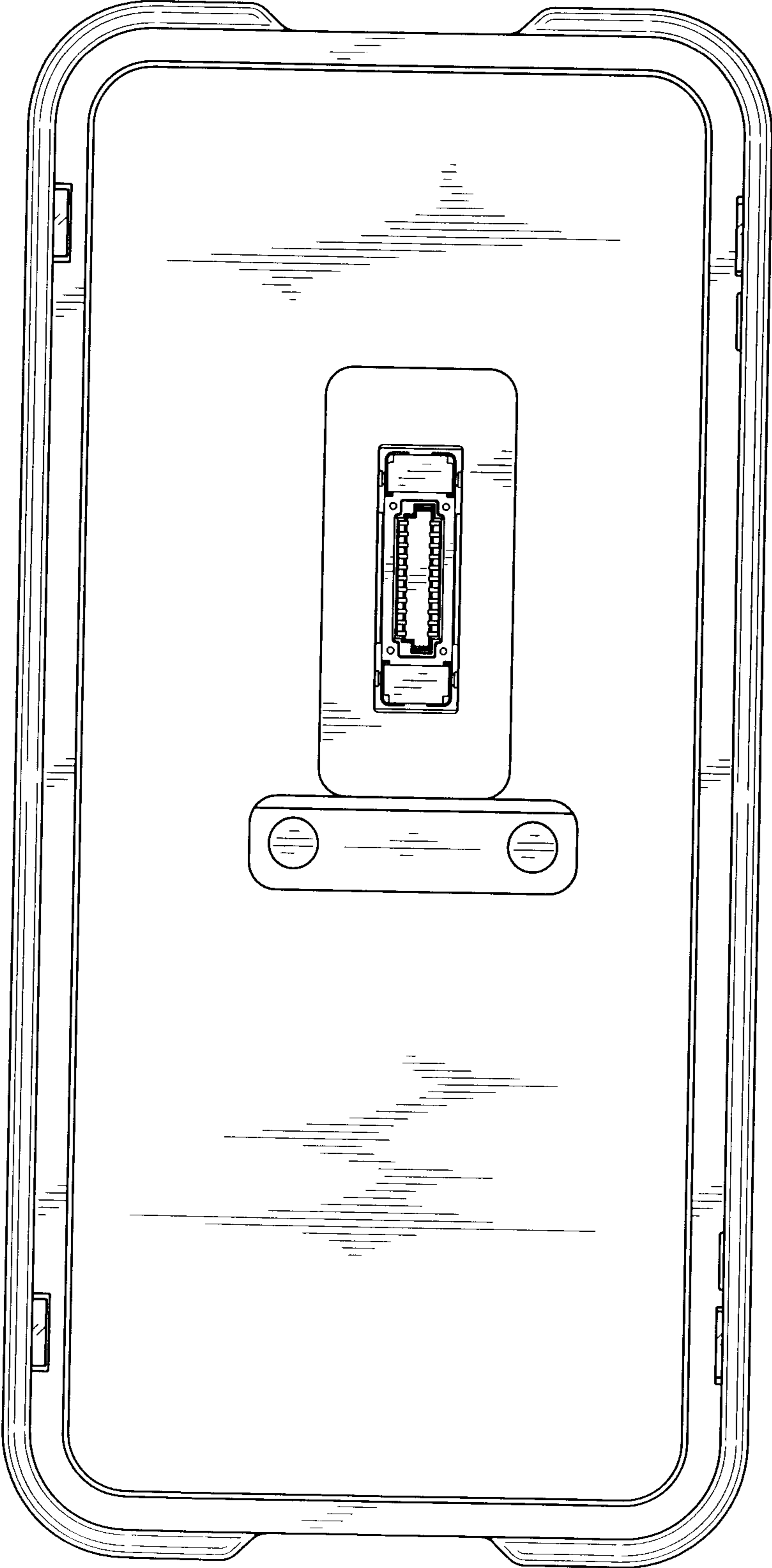

FIG. 3

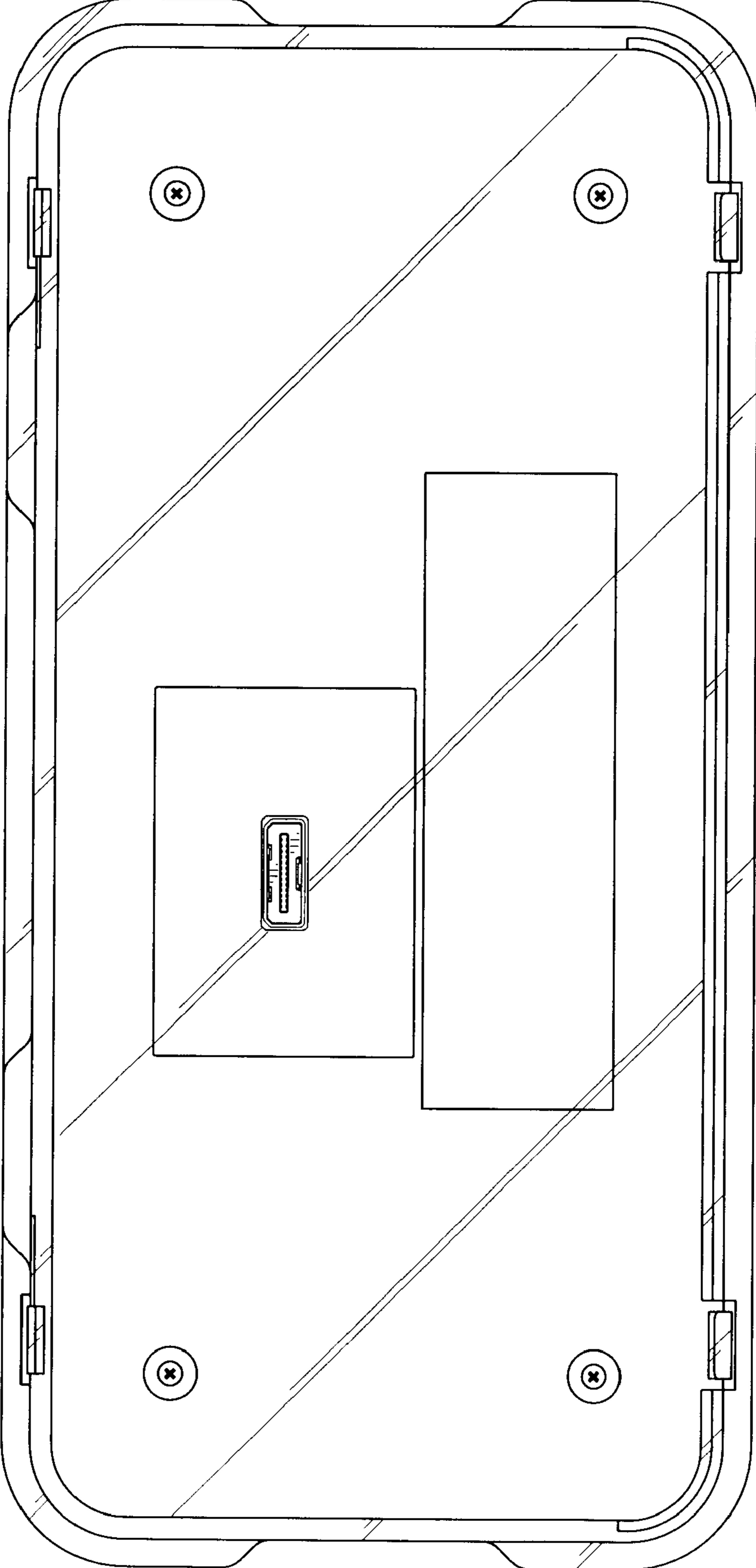

FIG. 4

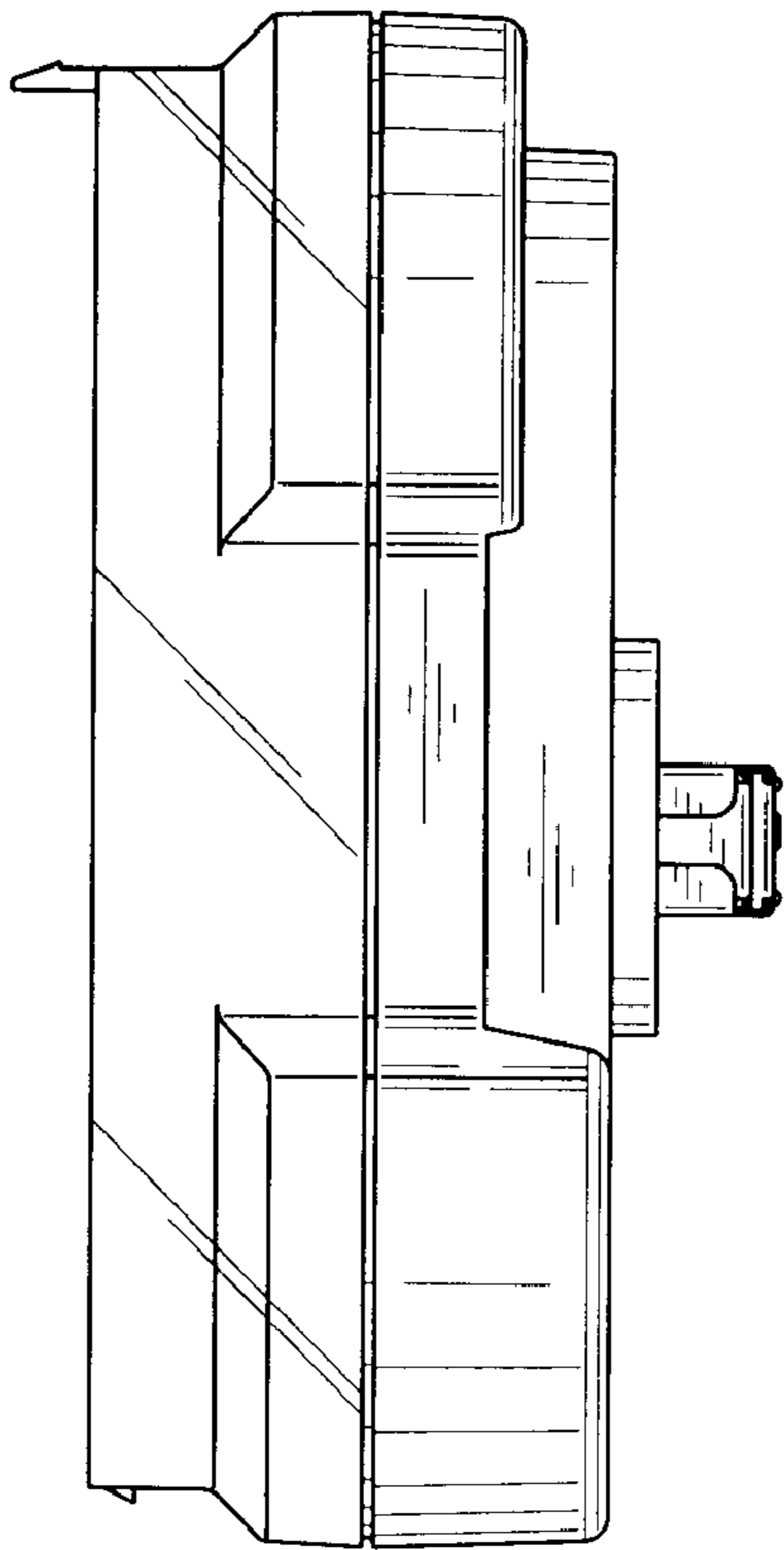

FIG. 5

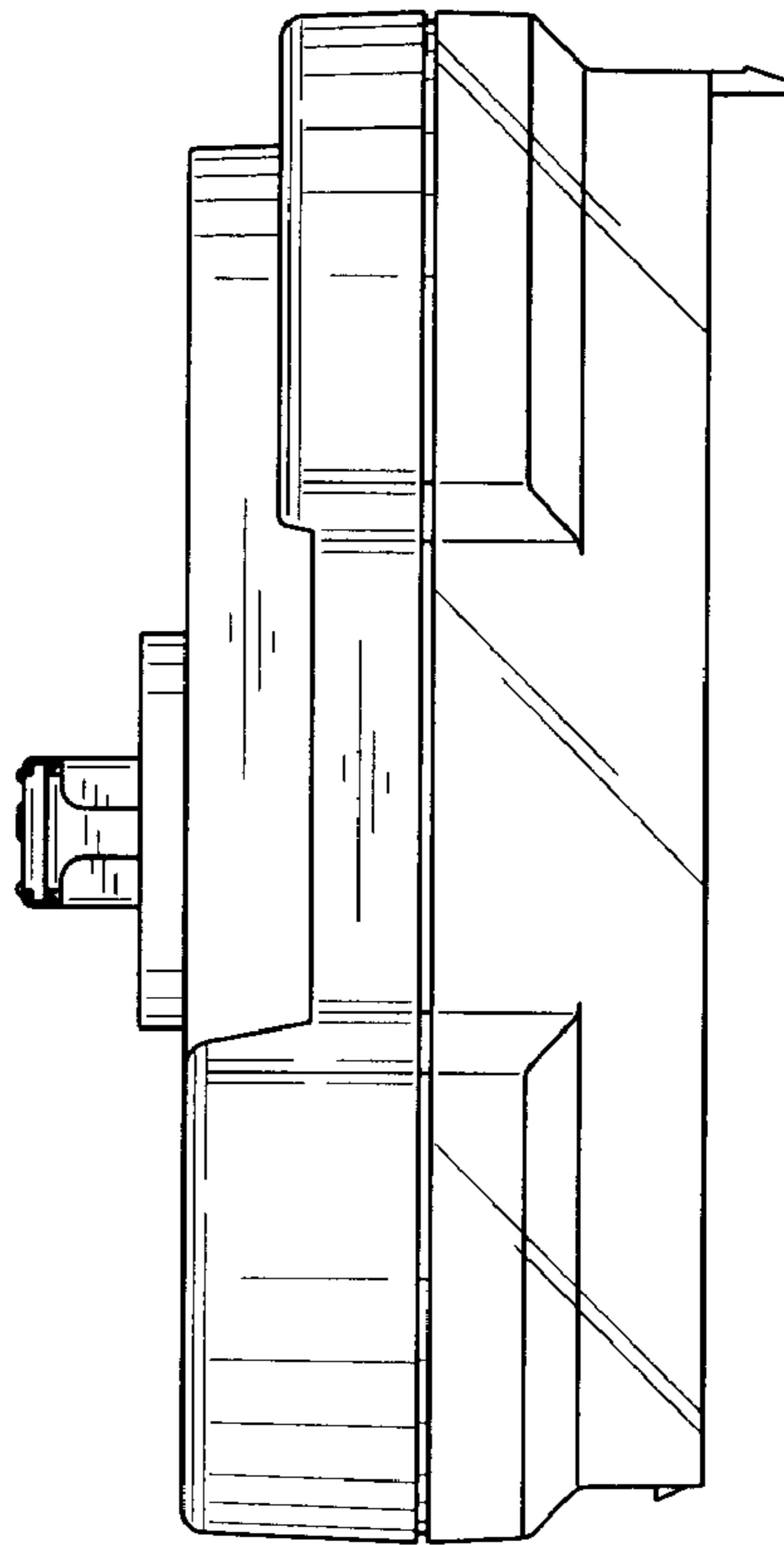

FIG. 6

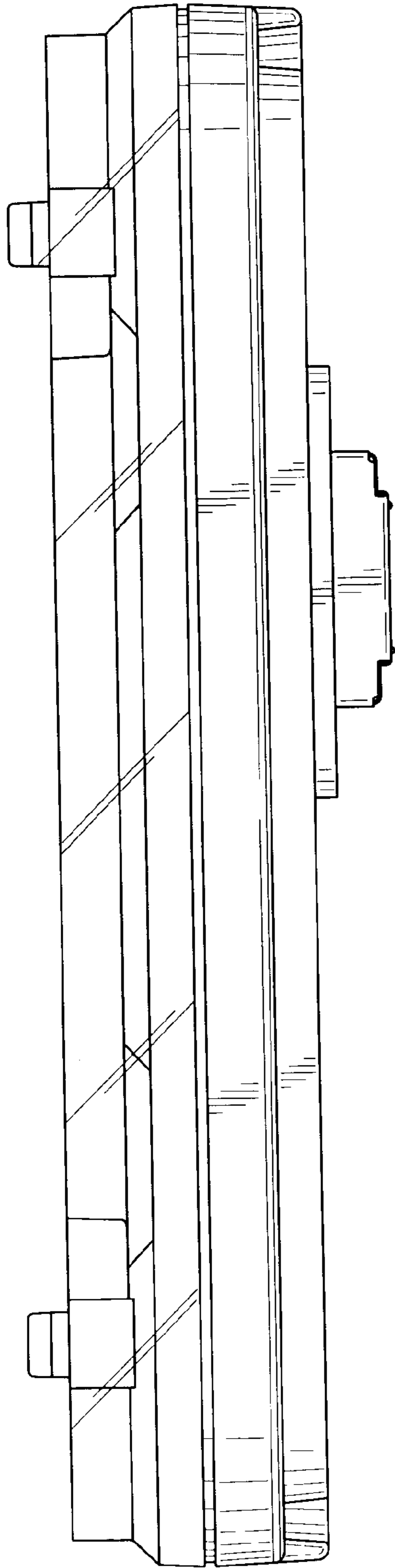

FIG. 7

