



US00D519445S

(12) **United States Design Patent**
Wang et al.

(10) **Patent No.:** **US D519,445 S**
(45) **Date of Patent:** **** Apr. 25, 2006**

(54) **CELL CHARGER**

(75) Inventors: **Nianqiang Wang**, Shenzhen (CN);
Yuanping Zhong, Shenzhen (CN); **Wei Li**, Shenzhen (CN); **Weihua Liu**, Shenzhen (CN); **Linzu Tian**, Shenzhen (CN)

(73) Assignee: **BYD Company Limited**, Shenzhen (CN)

(**) Term: **14 Years**

(21) Appl. No.: **29/202,916**

(22) Filed: **Apr. 7, 2004**

(30) **Foreign Application Priority Data**

Jan. 6, 2004 (CN) 2004300130356

(51) **LOC (8) Cl.** **13-02**

(52) **U.S. Cl.** **D13/107**

(58) **Field of Classification Search** D13/107-110,
D13/118-119, 184; D14/251, 253; 320/107-115
See application file for complete search history.

(56) **References Cited**

U.S. PATENT DOCUMENTS

- D358,363 S * 5/1995 Usami D13/107
- D442,544 S * 5/2001 Ku D13/107
- D443,856 S * 6/2001 Lehtovaara D13/107
- D454,837 S * 3/2002 Ibuki et al. D13/107
- 6,384,575 B1 * 5/2002 Chen et al. 320/110
- D463,360 S * 9/2002 Lie D13/107
- D465,452 S * 11/2002 Lie D13/107

- D466,075 S * 11/2002 Lie D13/107
- D478,557 S * 8/2003 Pfeiffer D13/184
- D483,014 S * 12/2003 Hsiao D13/107
- D501,824 S * 2/2005 Ku D13/107
- 6,876,172 B1 * 4/2005 Lam et al. 320/110

* cited by examiner

Primary Examiner—Pamela Burgess

Assistant Examiner—Rosemary Tarcza

(74) *Attorney, Agent, or Firm*—Squire, Sanders & Dempsey; Aaron Wininger

(57) **CLAIM**

The ornamental design for a cell charger, as shown and described.

DESCRIPTION

FIG. 1 is a perspective view in one side of the cell charger embodying our design;

FIG. 2 is a perspective view in another side of the cell charger embodying our design;

FIG. 3 is a front view of the of the cell charger as shown in FIGS. 1 and 2;

FIG. 4 is a back view of the of the cell charger as shown in FIGS. 1 and 2;

FIG. 5 is a left side elevational view of the cell charger as shown in FIGS. 1 and 2;

FIG. 6 is a right side elevational view of the cell charger as shown in FIG. 1 and 2;

FIG. 7 is a top plan view of the cell charger as shown in FIGS. 1 and 2; and,

FIG. 8 is a bottom plan view of the cell charger as shown in FIGS. 1 and 2.

1 Claim, 5 Drawing Sheets

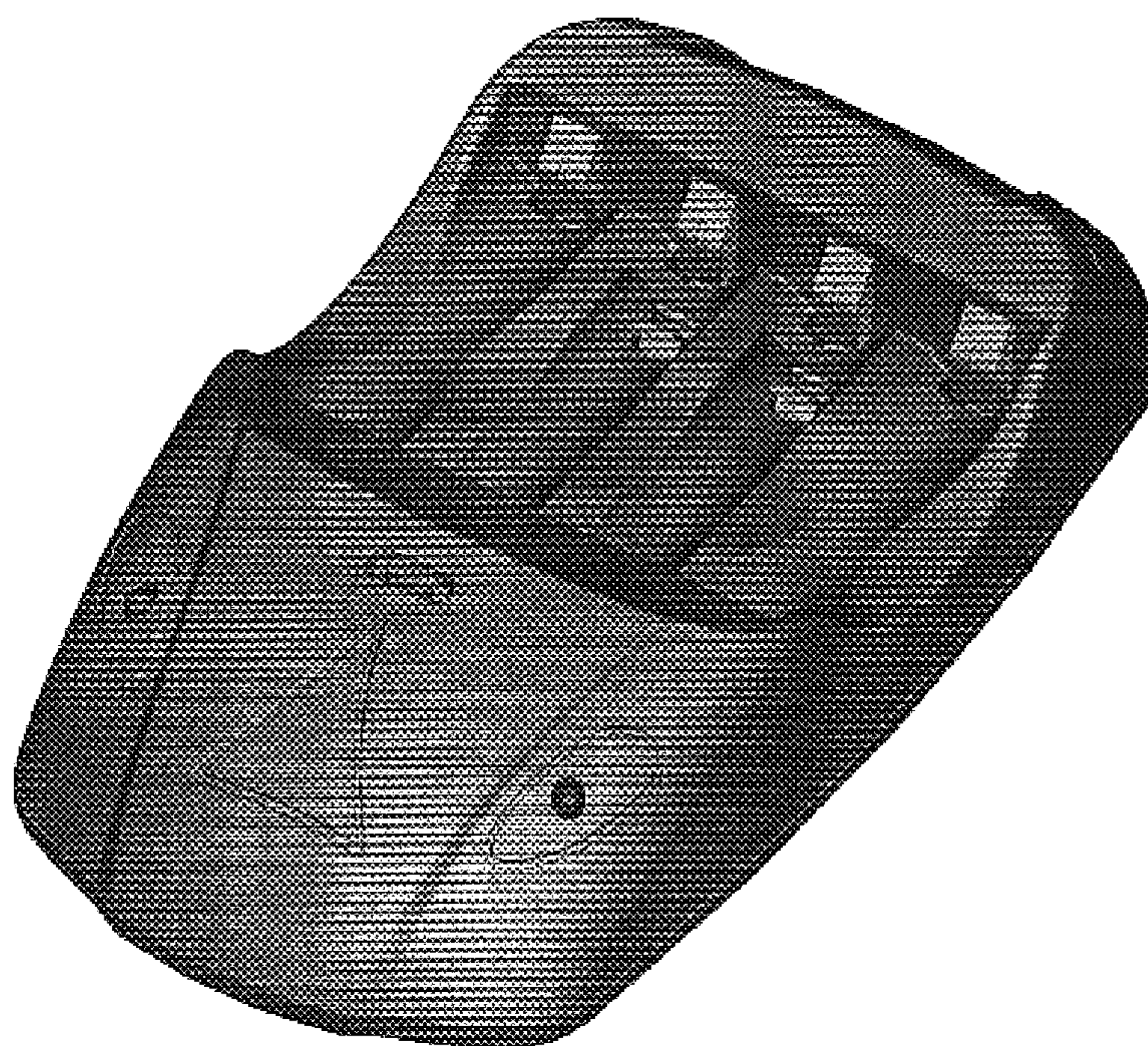

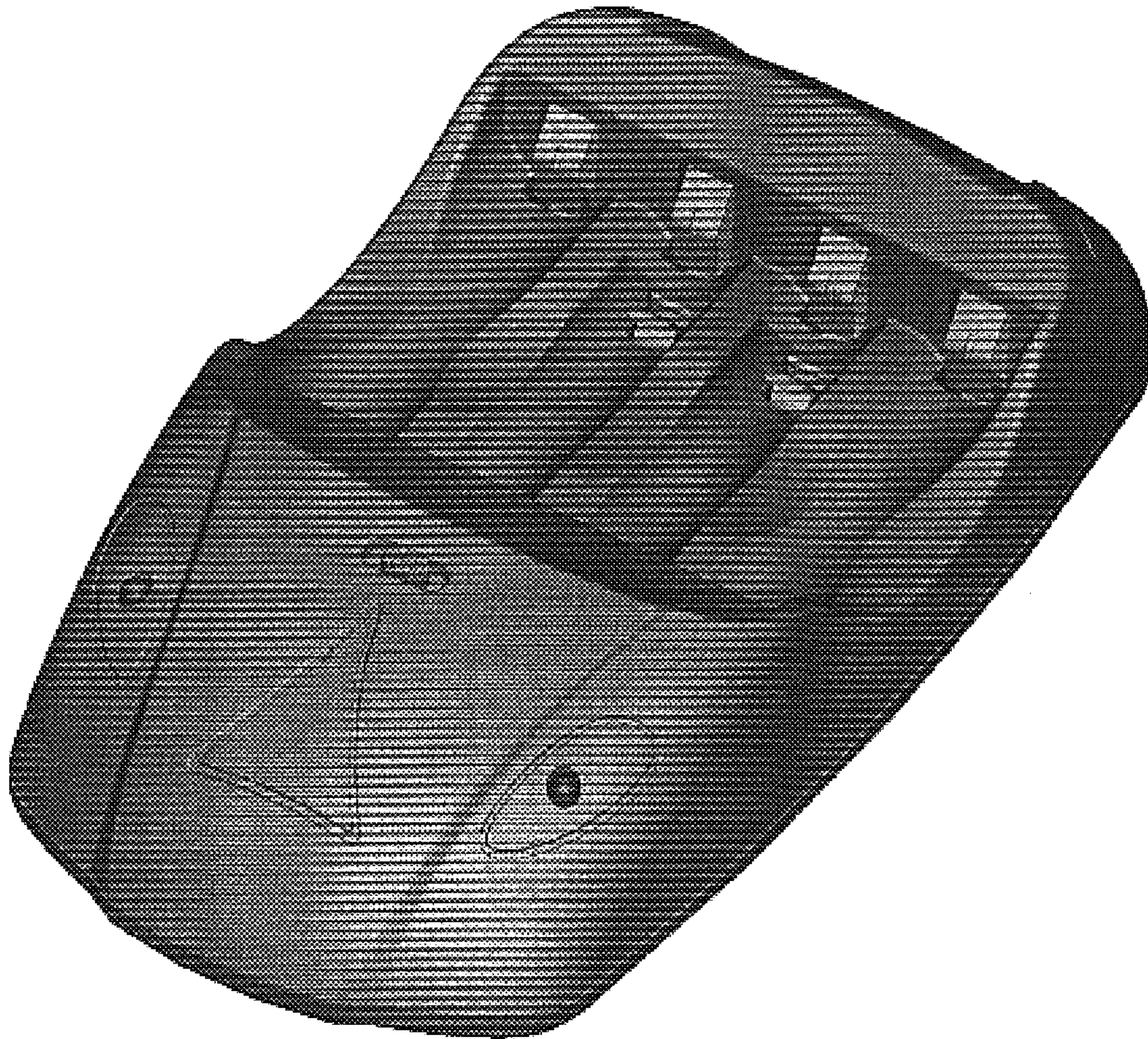

Figure 1

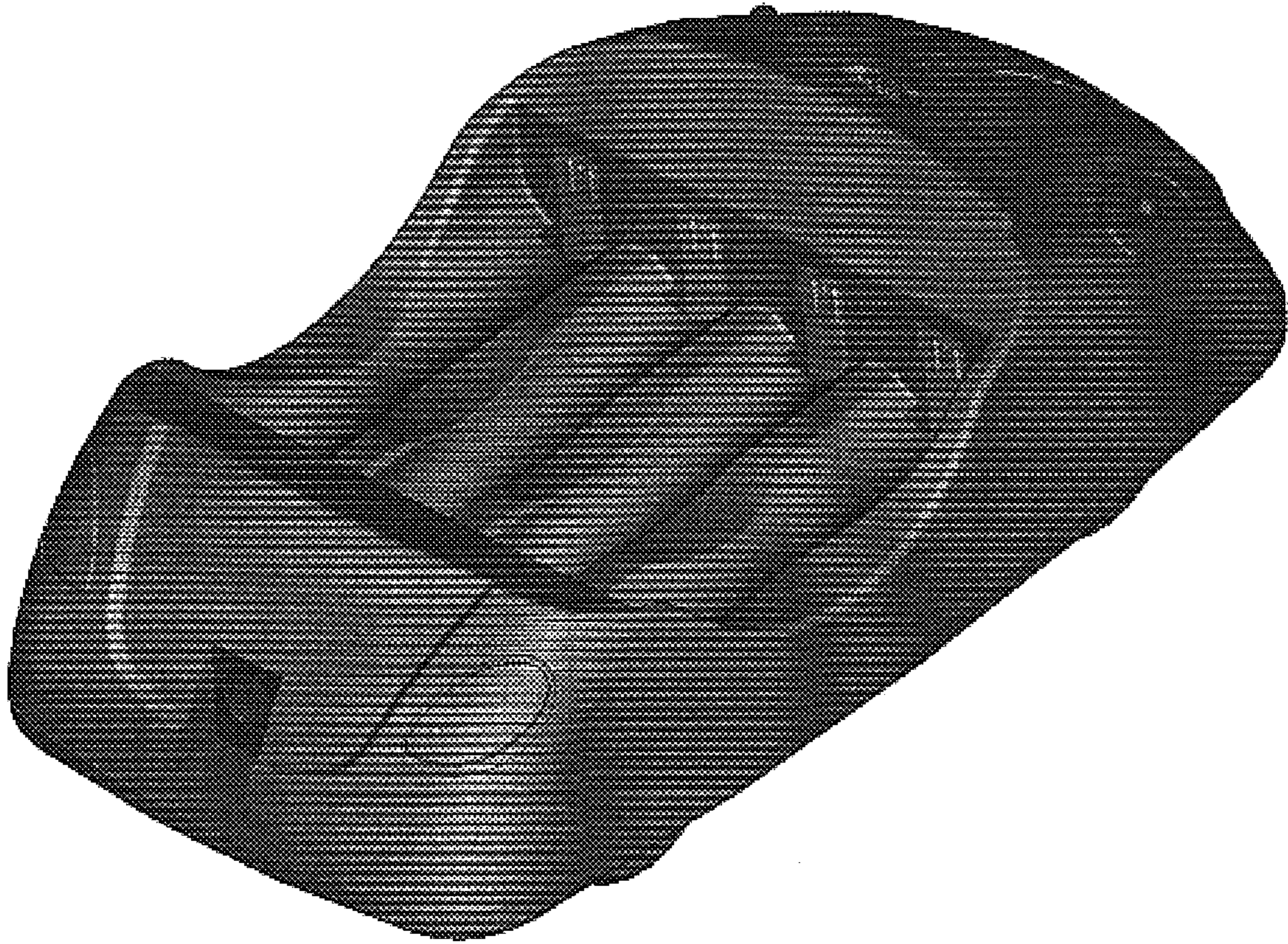

Figure 2

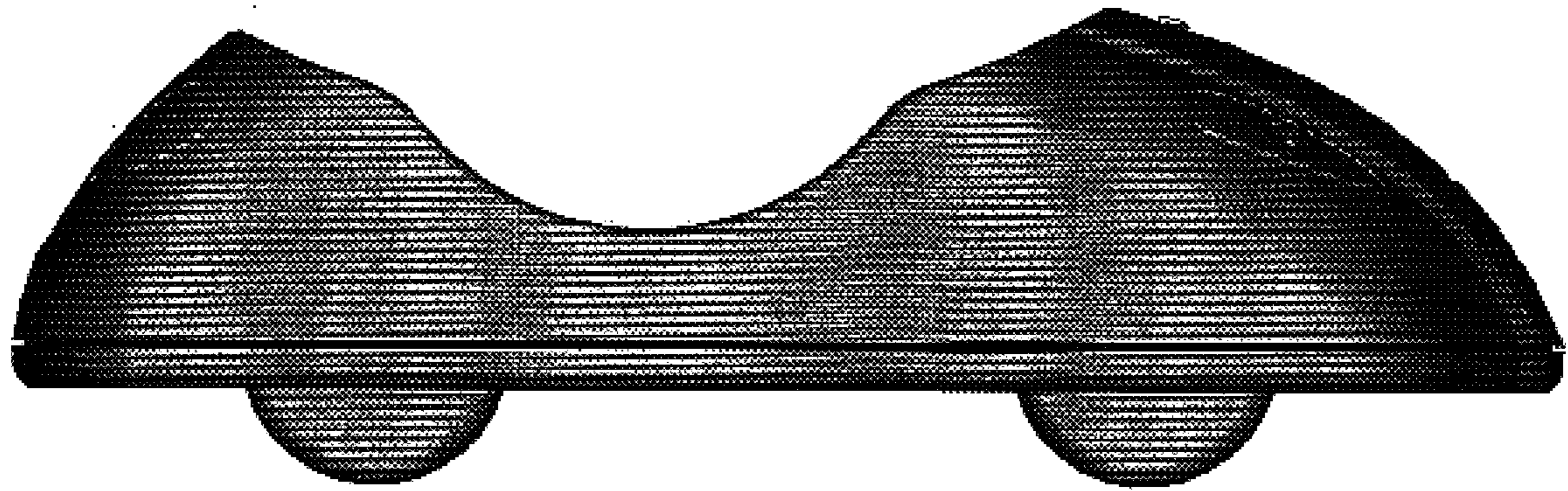

Figure 3

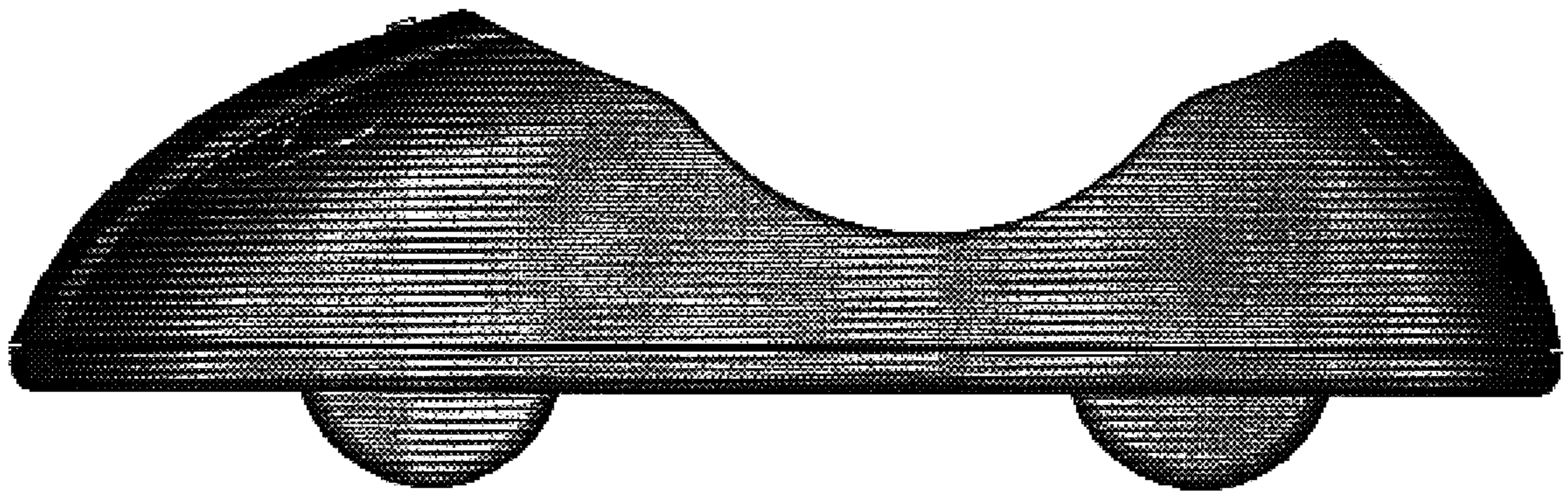

Figure 4

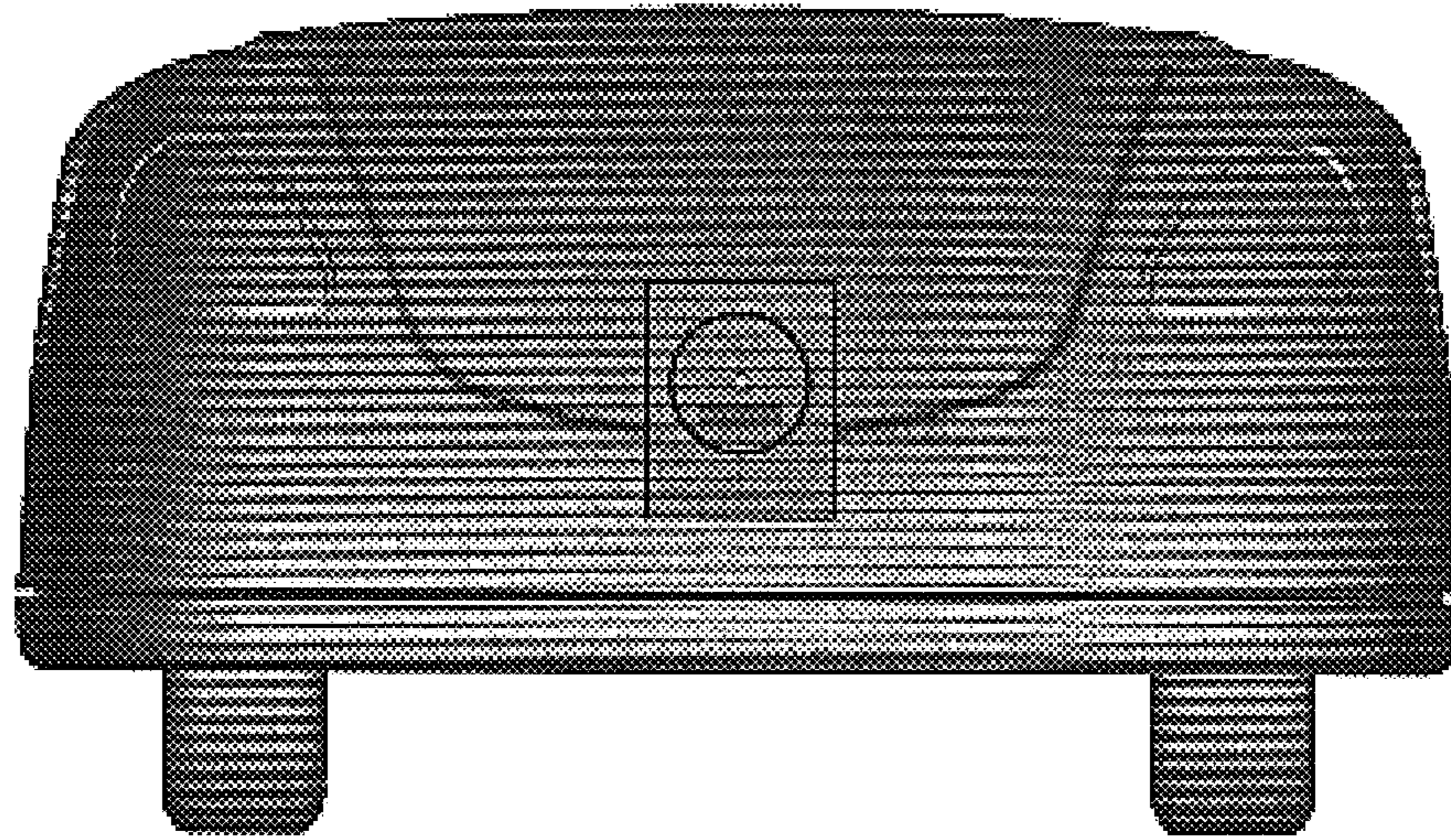

Figure 5

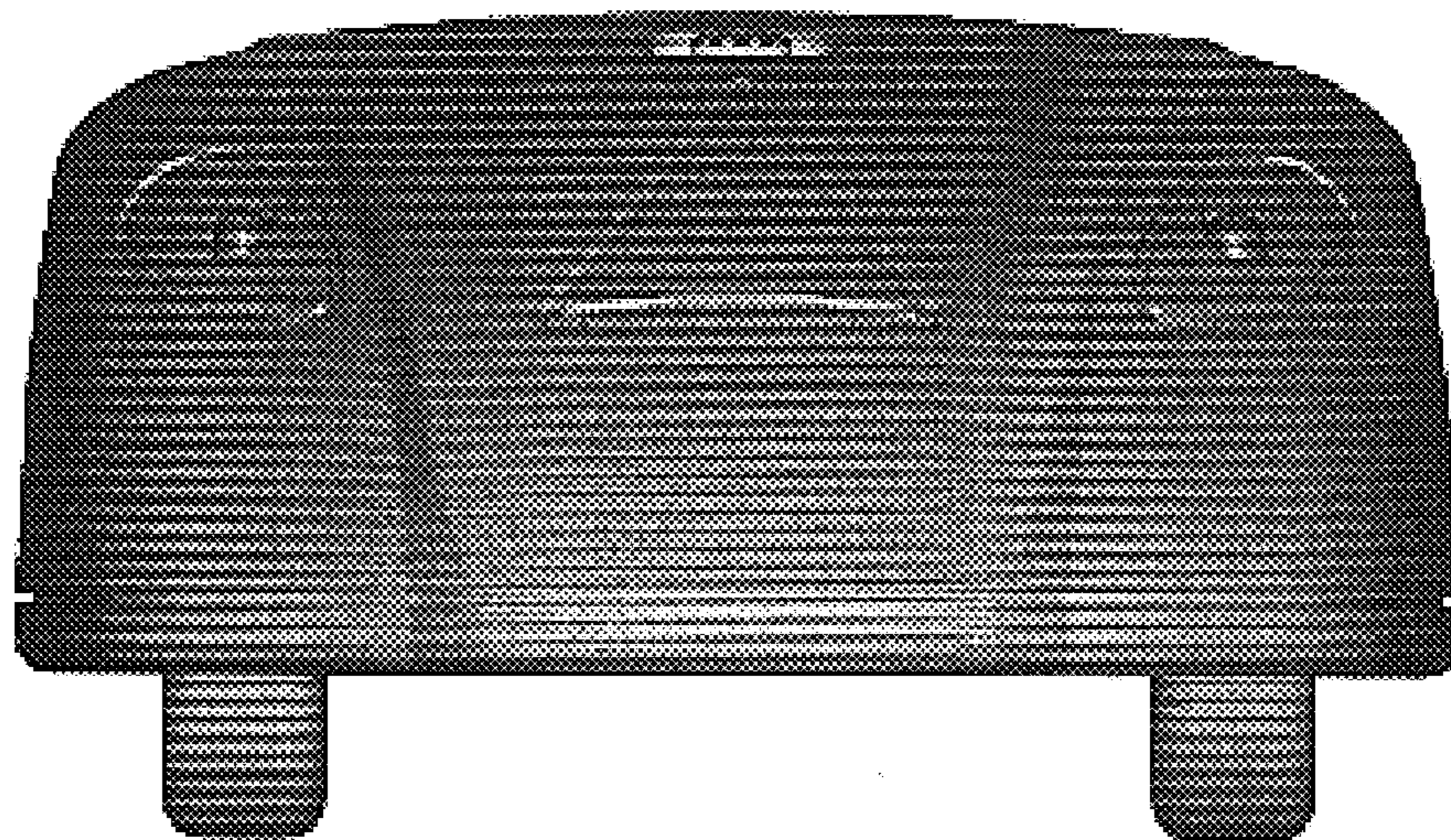

Figure 6

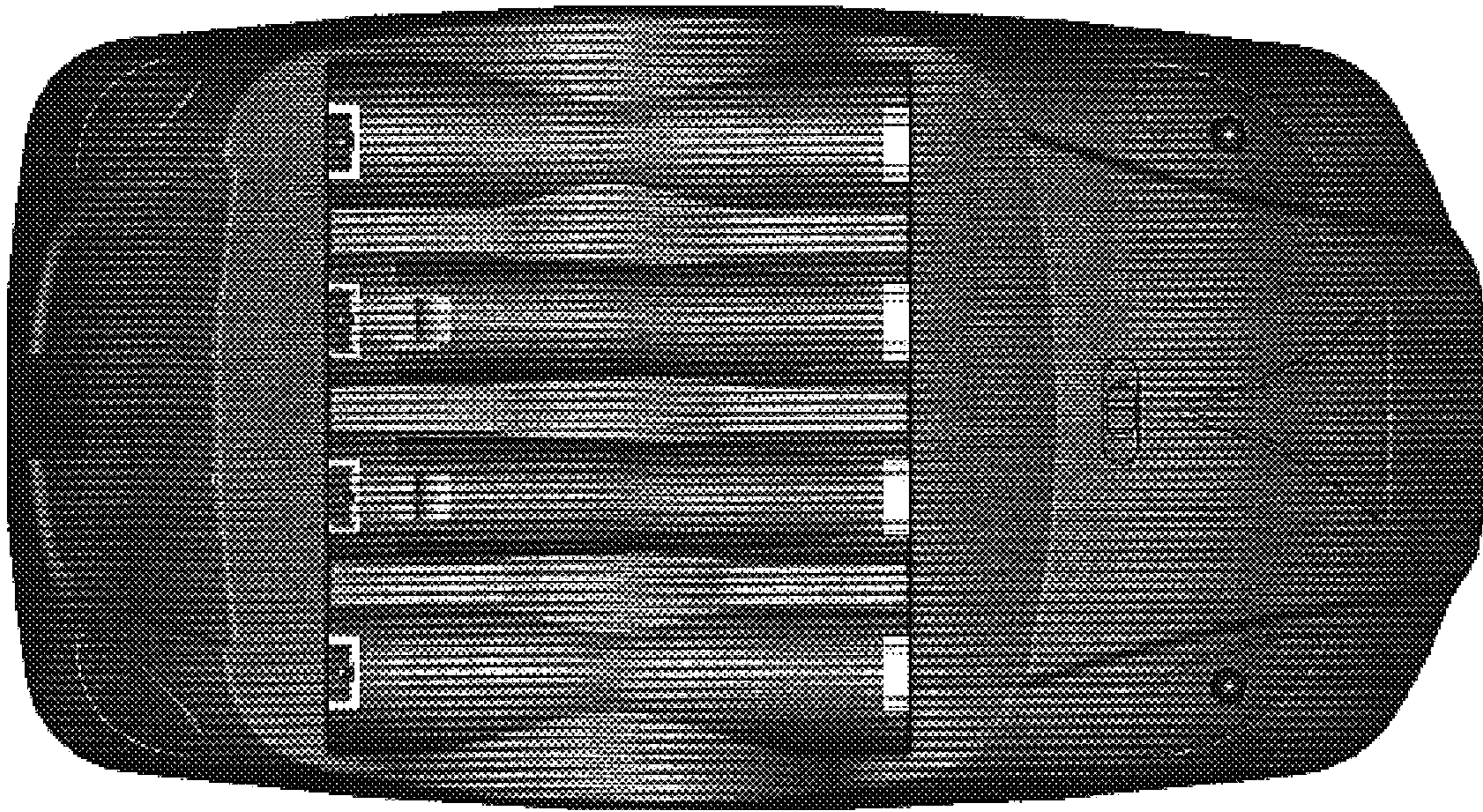

Figure 7

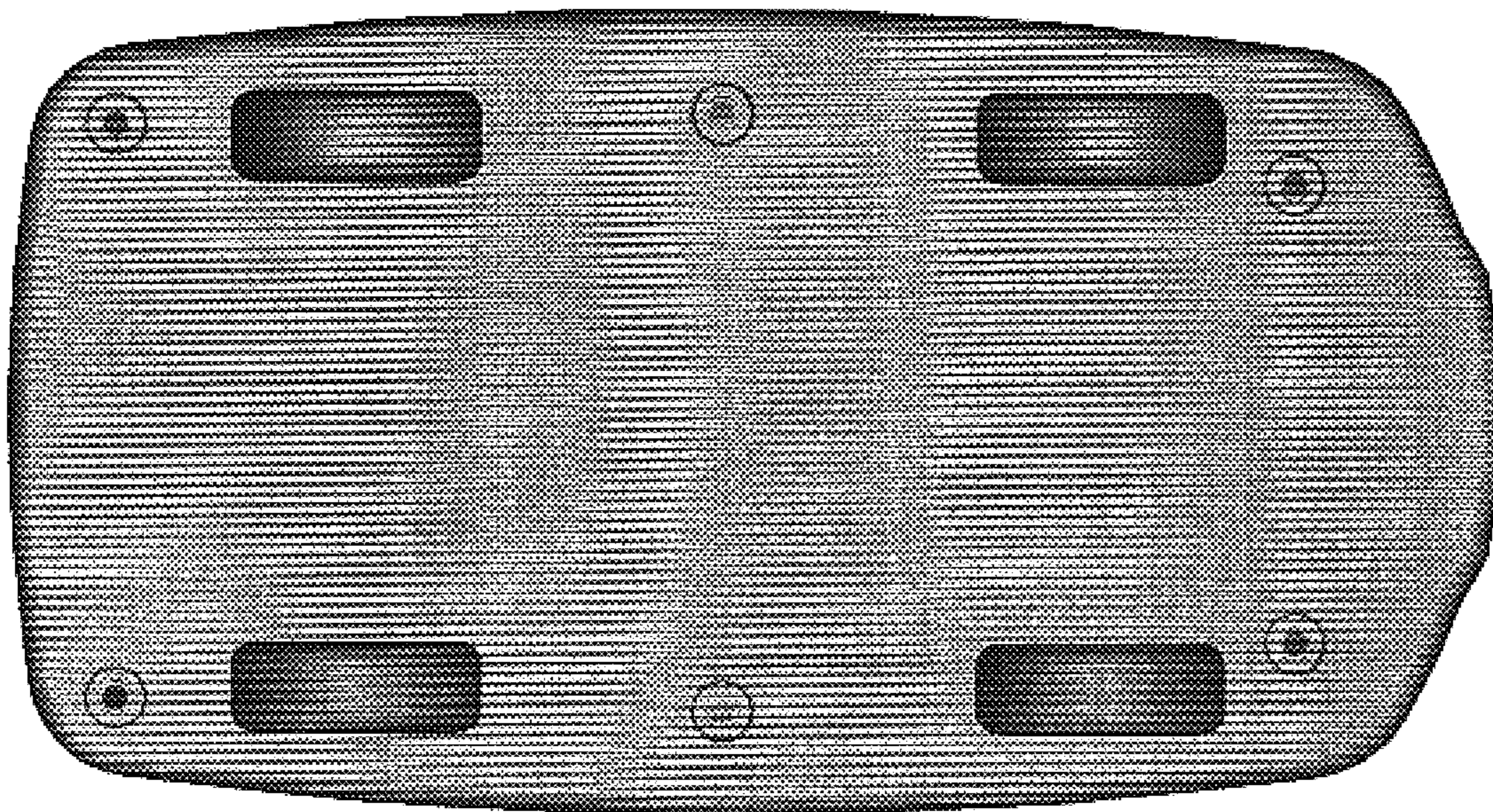

Figure 8