



US00D519437S

(12) **United States Design Patent**
Bucaccio et al.

(10) **Patent No.:** **US D519,437 S**

(45) **Date of Patent:** **** Apr. 25, 2006**

(54) **PERSONAL WATERCRAFT**

(75) Inventors: **Tom Bucaccio**, Sebastian, FL (US);
Shannon Cassell, Palm Bay, FL (US);
Kirk Aguero, Indialantic, FL (US)

(73) Assignee: **Bombardier Recreational Products Inc.**, Valcourt (CA)

(**) Term: **14 Years**

(21) Appl. No.: **29/235,791**

(22) Filed: **Aug. 8, 2005**

Related U.S. Application Data

(62) Division of application No. 29/211,683, filed on Aug. 20, 2004.

(51) **LOC (8) Cl.** **12-06**

(52) **U.S. Cl.** **D12/307; D12/317**

(58) **Field of Classification Search** D12/300,
D12/307, 316, 317; 114/55.5, 55.55, 55.57,
114/270, 271; D21/542

See application file for complete search history.

(56) **References Cited**

U.S. PATENT DOCUMENTS

- D340,221 S * 10/1993 Krieger et al. D12/307
- D342,052 S * 12/1993 Schoell et al. D12/307
- D343,160 S 1/1994 LaPointe
- D350,325 S 9/1994 Mardikian
- D359,469 S * 6/1995 Yoshida et al. D12/307
- D444,761 S * 7/2001 Momoi et al. D12/307

- D464,926 S 10/2002 Mizuta et al.
- D478,035 S * 8/2003 Bills et al. D12/317
- D479,702 S 9/2003 Cassell et al.
- D485,527 S * 1/2004 Cassell et al. D12/307
- D487,244 S * 3/2004 Bucaccio et al. D12/307
- D494,529 S * 8/2004 Cassell et al. D12/307
- D507,230 S * 7/2005 Bucaccio et al. D12/317

* cited by examiner

Primary Examiner—Holly Baynham
Assistant Examiner—Cynthia M. Chin

(74) *Attorney, Agent, or Firm*—Osler, Hoskin & Harcourt LLP

(57) **CLAIM**

The ornamental design for a personal watercraft, as shown and described.

DESCRIPTION

FIG. 1 is a front-right perspective view of a personal watercraft according to our design;
FIG. 2 is a front view thereof;
FIG. 3 is a rear view thereof;
FIG. 4 is a top view thereof;
FIG. 5 is a left view thereof; and,
FIG. 6 is a right view thereof.

Where included, the broken lines showing environment or structure are for illustrative purposes only and form no part of claimed design.

The portions of the personal watercraft which are not shown in the drawings form no part of the claimed design.

1 Claim, 5 Drawing Sheets

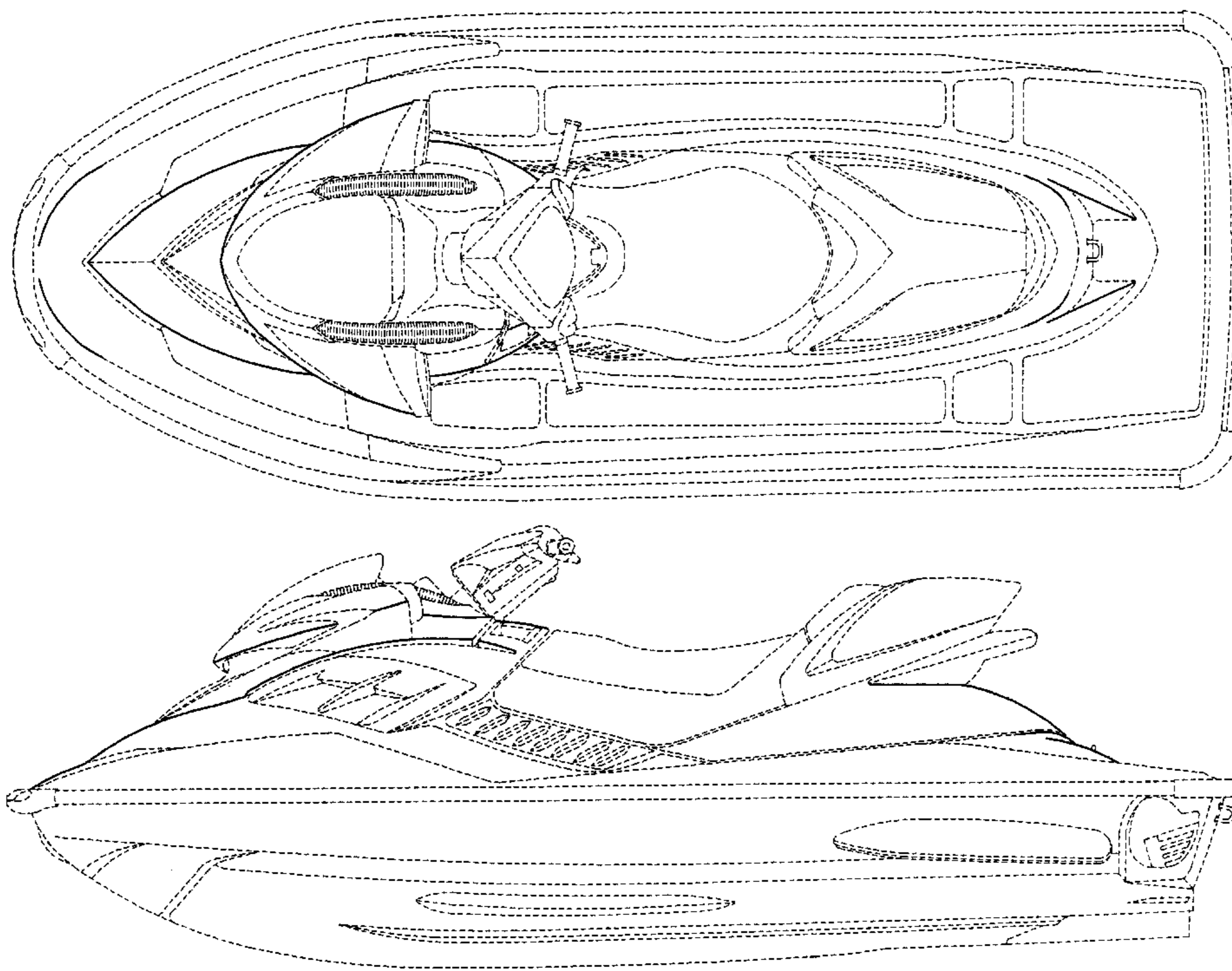

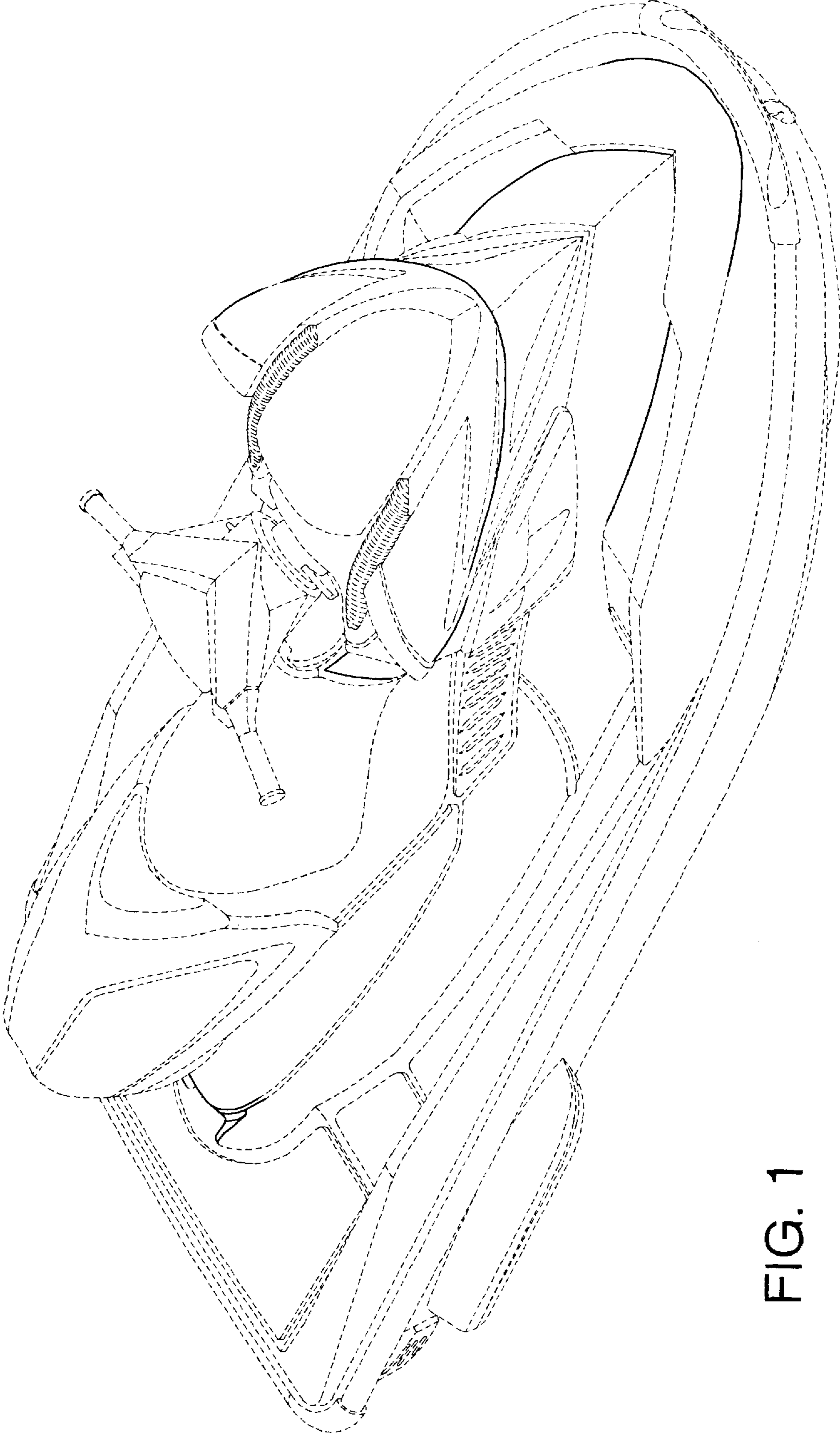

FIG. 1

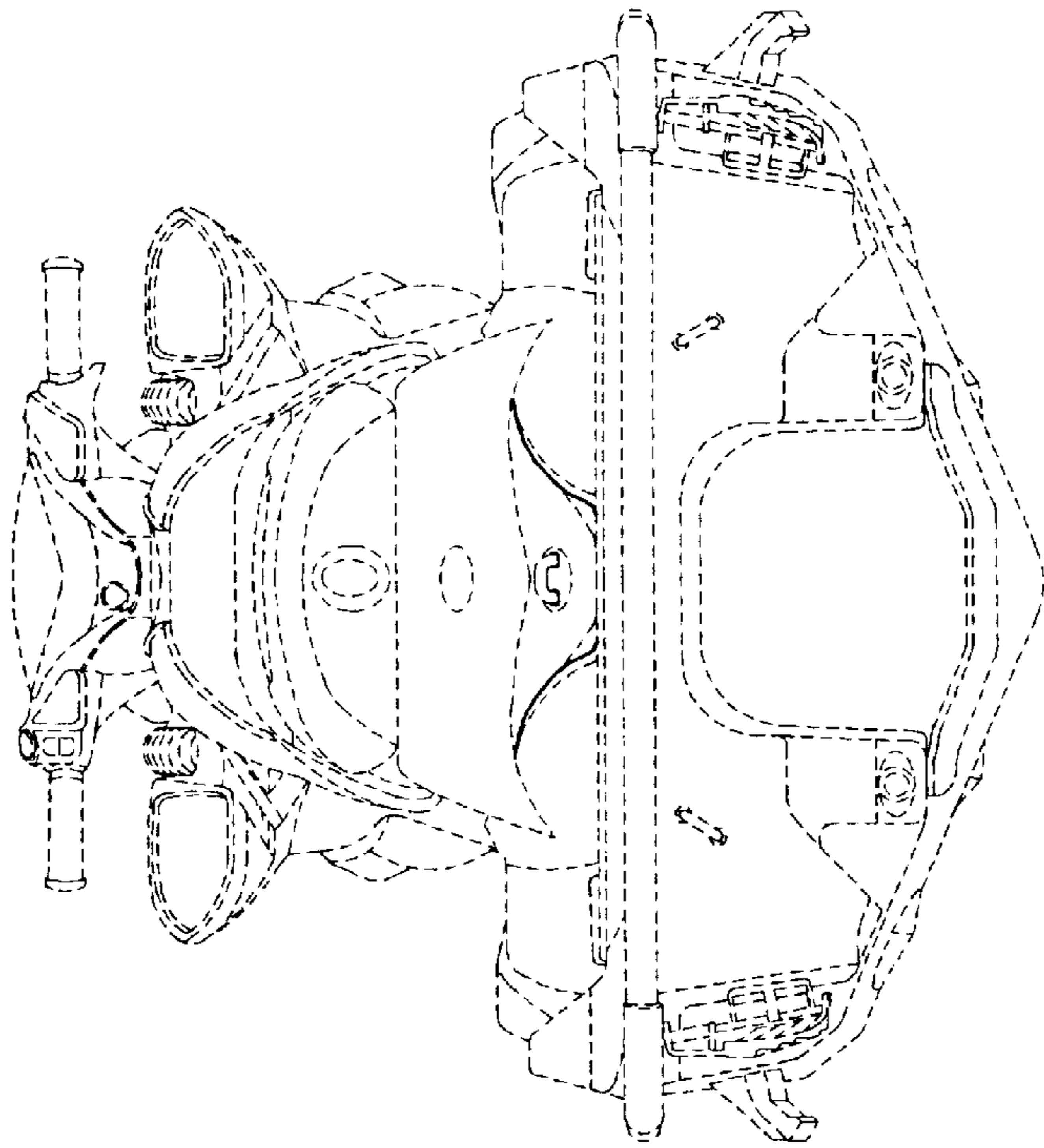

FIG. 3

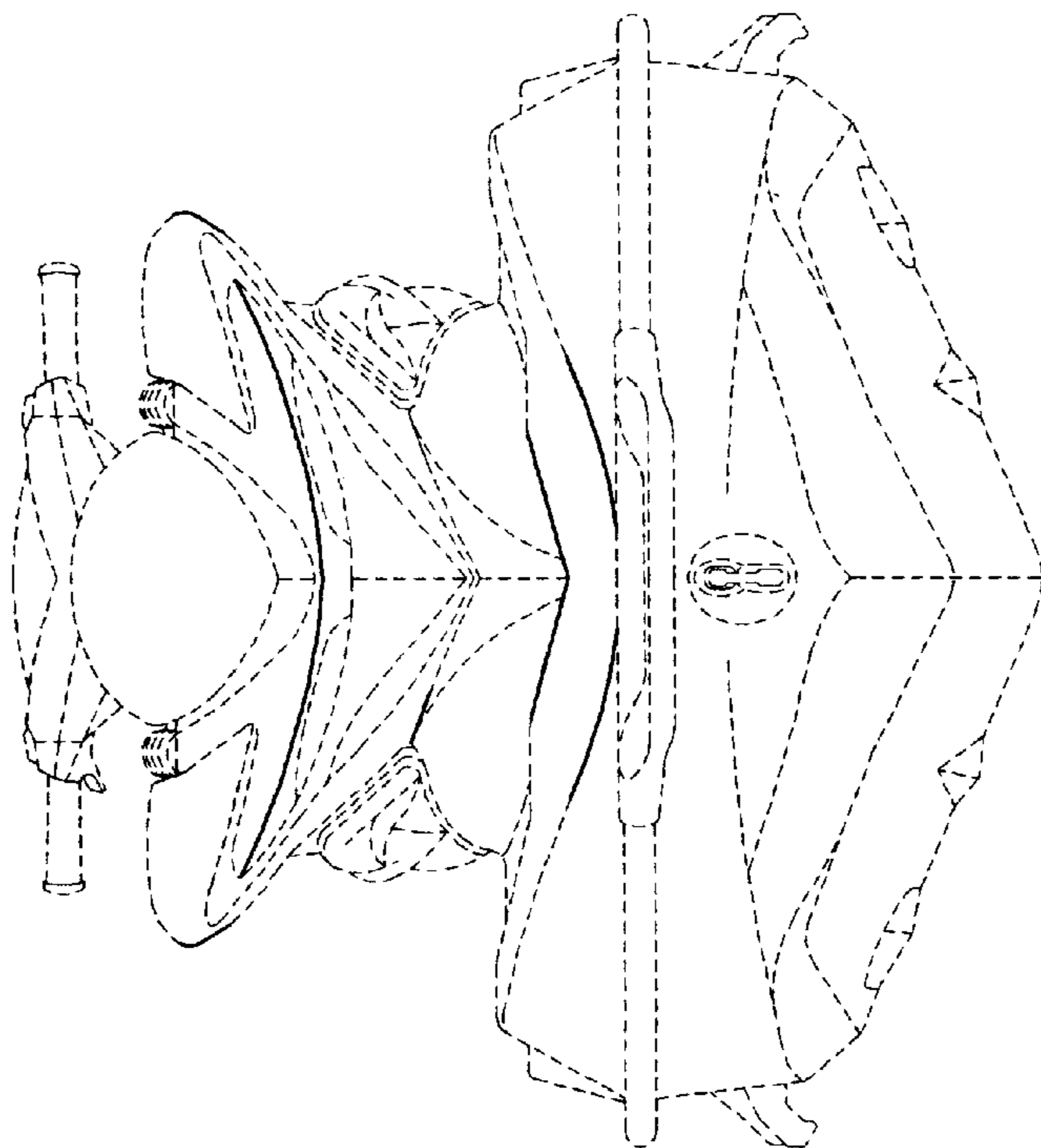

FIG. 2

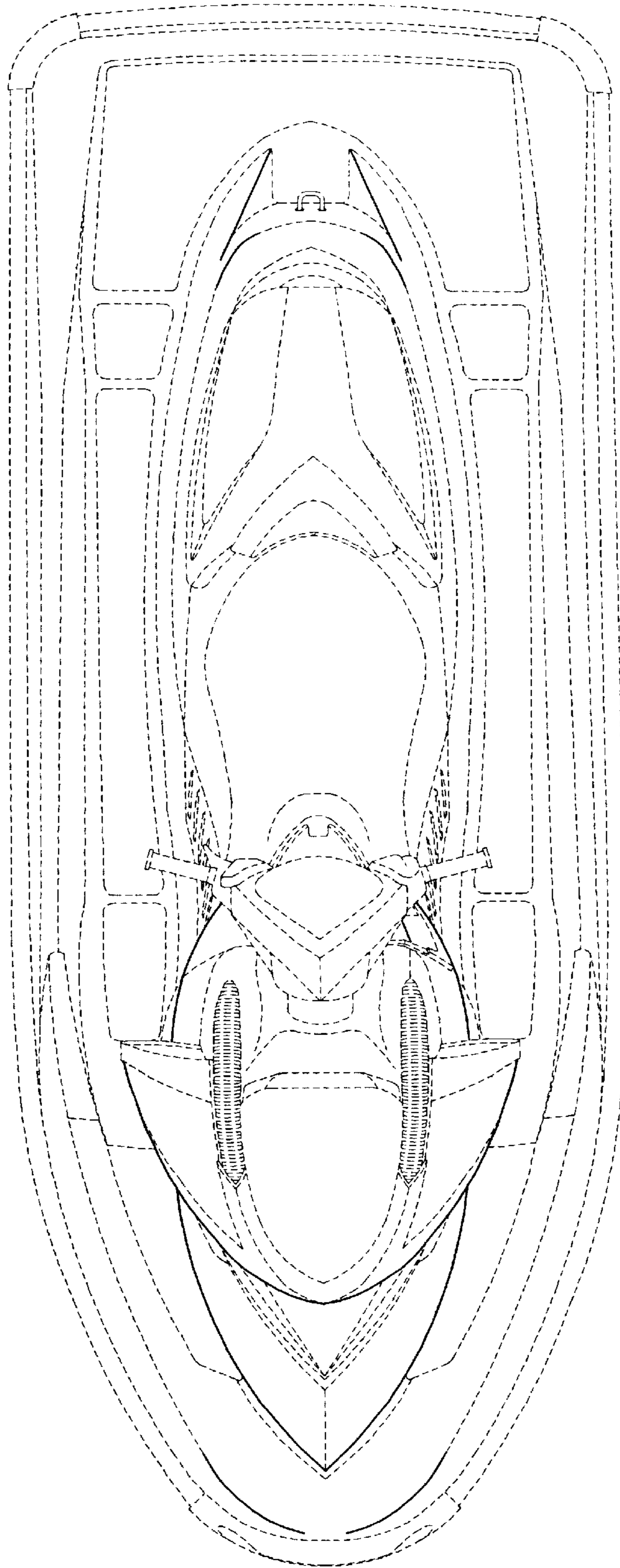

FIG. 4

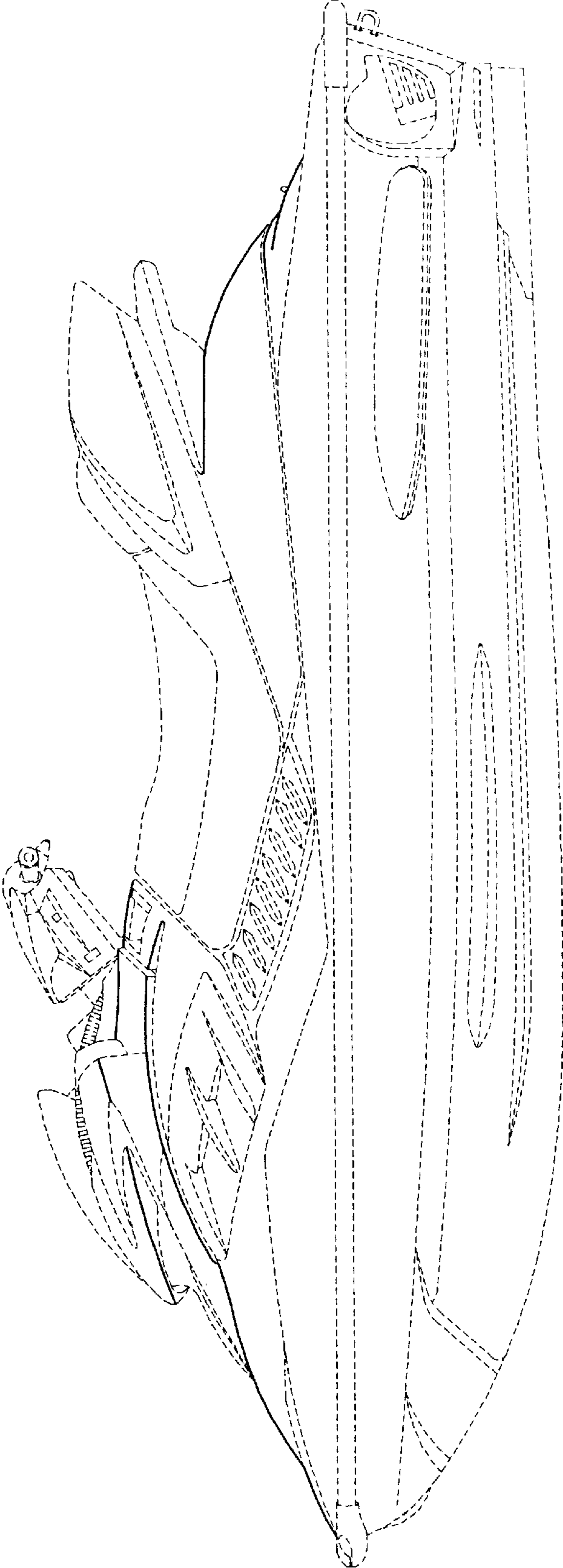

FIG. 5

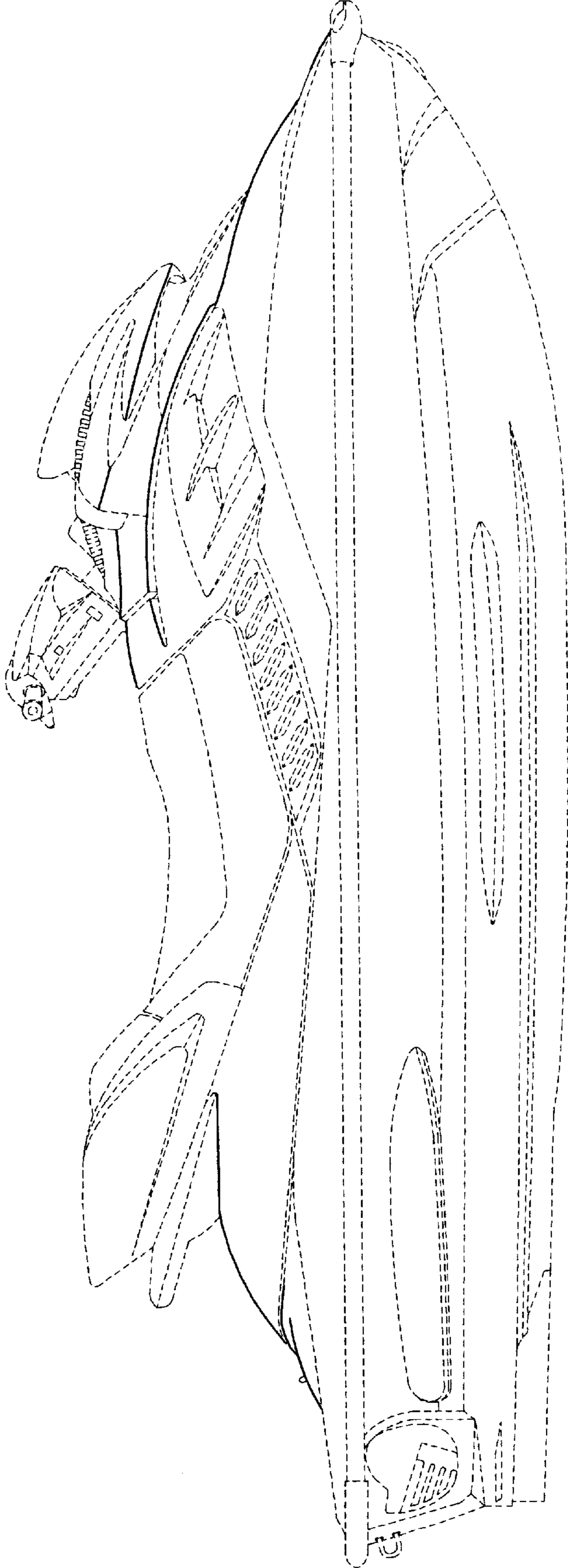

FIG. 6