



US00D519339S

(12) **United States Design Patent**
Kovach

(10) **Patent No.:** **US D519,339 S**

(45) **Date of Patent:** **** Apr. 25, 2006**

(54) **LOG-POSITIONING IMPLEMENT FOR
CAMP FIRES**

(76) Inventor: **Edward Kovach**, 901 Woodbourne
Ave., Pittsburgh, PA (US) 15226

(**) Term: **14 Years**

(21) Appl. No.: **29/223,138**

(22) Filed: **Feb. 10, 2005**

(51) **LOC (8) Cl.** **08-05**

(52) **U.S. Cl.** **D8/14**

(58) **Field of Classification Search** D8/14;
D7/683; D23/403; 294/10-11, 14, 26, 61;
30/323; 99/421 R

See application file for complete search history.

(56) **References Cited**

U.S. PATENT DOCUMENTS

- 131,618 A 9/1872 Klein
- 1,857,841 A 5/1932 Engel
- 2,791,959 A * 5/1957 Pirz 99/421 R
- D189,441 S * 12/1960 Bonnell D7/683

- 3,042,438 A 7/1962 Turner
- 3,574,380 A 4/1971 Tague
- 4,307,909 A 12/1981 Yaworski
- 4,889,375 A 12/1989 Leu
- 4,955,647 A 9/1990 Alfredson
- D386,578 S 11/1997 Mele

* cited by examiner

Primary Examiner—Holly H. Baynham

(57) **CLAIM**

The ornamental design for a log-positioning implement for camp fires, as shown and described.

DESCRIPTION

FIG. 1 is a front elevational view of a log-positioning implement for camp fires showing my new design; FIG. 2 is a left side elevational view thereof; FIG. 3 is a right side elevational view thereof; FIG. 4 is a top plan view thereof; FIG. 5 is a bottom plan view thereof; and, FIG. 6 is a perspective view thereof.

1 Claim, 2 Drawing Sheets

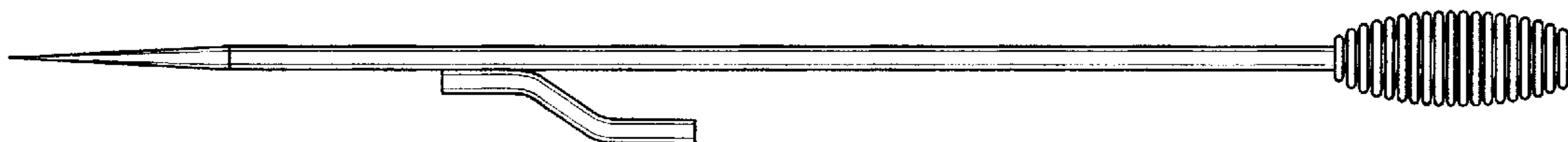

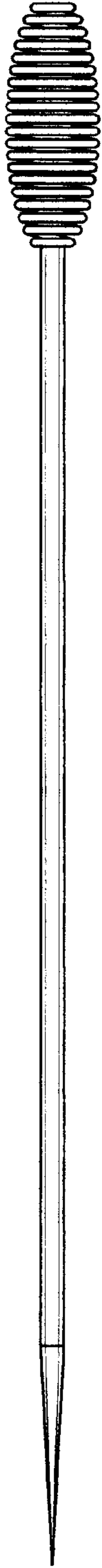

FIG. 4

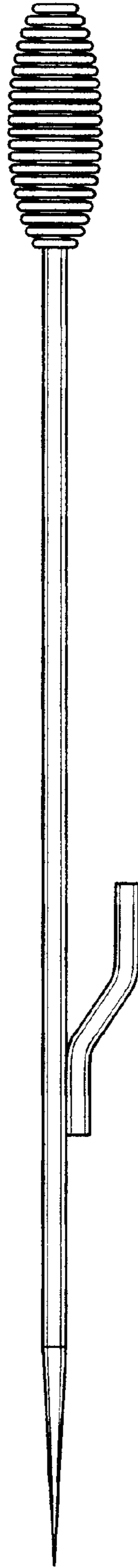

FIG. 1

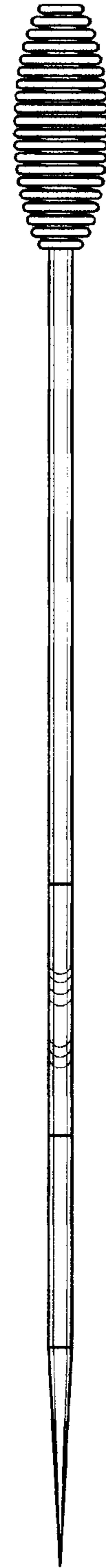

FIG. 5

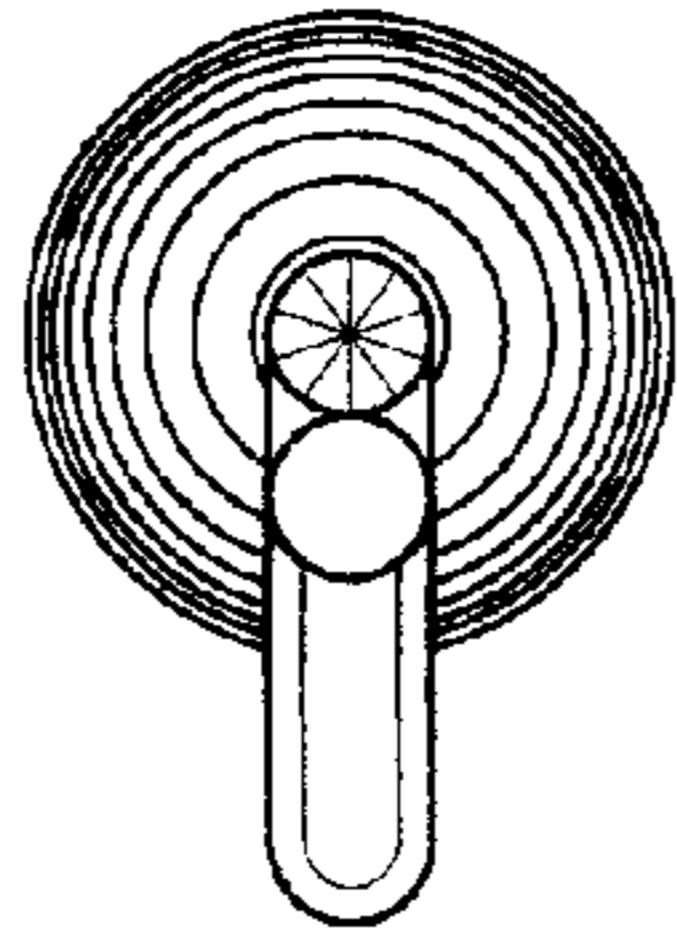

FIG. 2

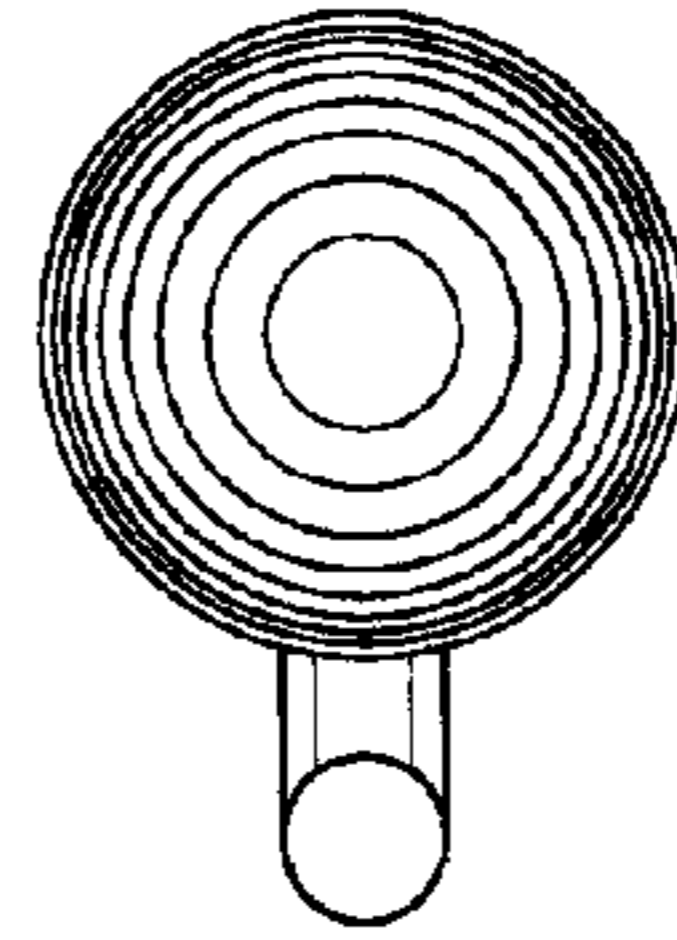

FIG. 3

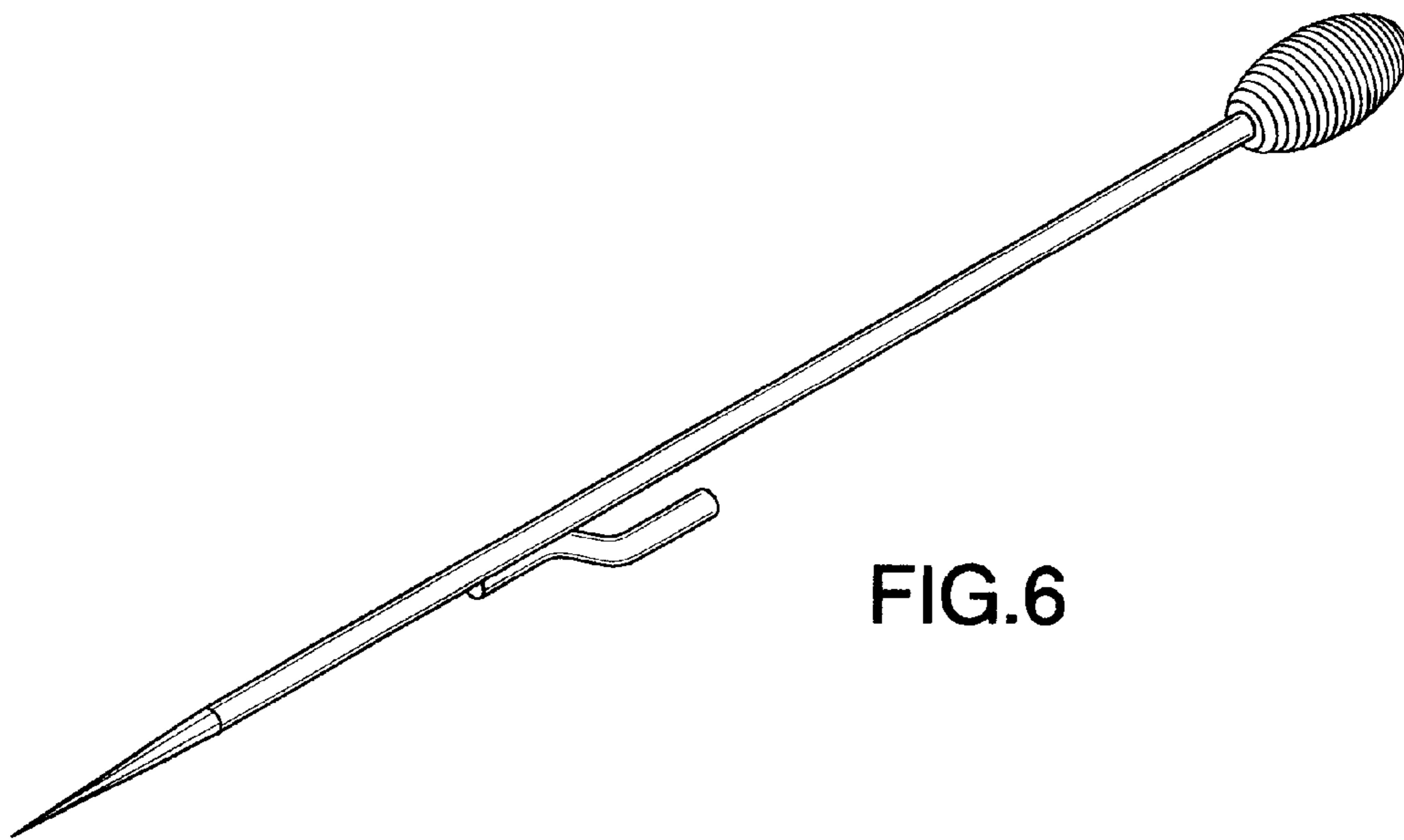

FIG. 6