



US00D519234S

(12) **United States Design Patent**  
**Lee**

(10) **Patent No.:** **US D519,234 S**  
(45) **Date of Patent:** **\*\* Apr. 18, 2006**

(54) **HAND ACTUATABLE LIGHT DEVICE**

(76) Inventor: **Wen Sung Lee**, 8F-2, No. 60-2, Gong  
Yeh Chu 1st Road, Taichung 40767  
(TW)

(\*\*) Term: **14 Years**

(21) Appl. No.: **29/226,861**

(22) Filed: **Apr. 4, 2005**

(51) **LOC (8) Cl.** ..... **26-02**

(52) **U.S. Cl.** ..... **D26/37**

(58) **Field of Classification Search** ..... D26/37-50;  
362/157, 158, 171-174, 183-208  
See application file for complete search history.

(56) **References Cited**

**U.S. PATENT DOCUMENTS**

D508,139 S \* 8/2005 Yen ..... D26/37  
D509,611 S \* 9/2005 Chou ..... D26/37

\* cited by examiner

*Primary Examiner*—Marcus A. Jackson

(74) *Attorney, Agent, or Firm*—Charles E. Baxley

(57) **CLAIM**

The ornamental design for a hand actuable light device, as shown and described.

**DESCRIPTION**

FIG. 1 is an upper perspective view of a hand actuable light device showing my new design; FIG. 2 is a front elevational view thereof; FIG. 3 is a rear elevational view thereof; FIG. 4 is a top plan view thereof; FIG. 5 is a bottom plan view thereof; FIG. 6 is a left side elevational view thereof; FIG. 7 is a right side elevational view thereof; FIG. 8 is a bottom perspective view thereof; and, FIG. 9 is a bottom perspective view thereof, illustrating rotational movement of the rotatable hand grip. The broken line showing of the handle in a raised alternate position is for illustrative purposes only and forms no part of the claimed design.

**1 Claim, 8 Drawing Sheets**

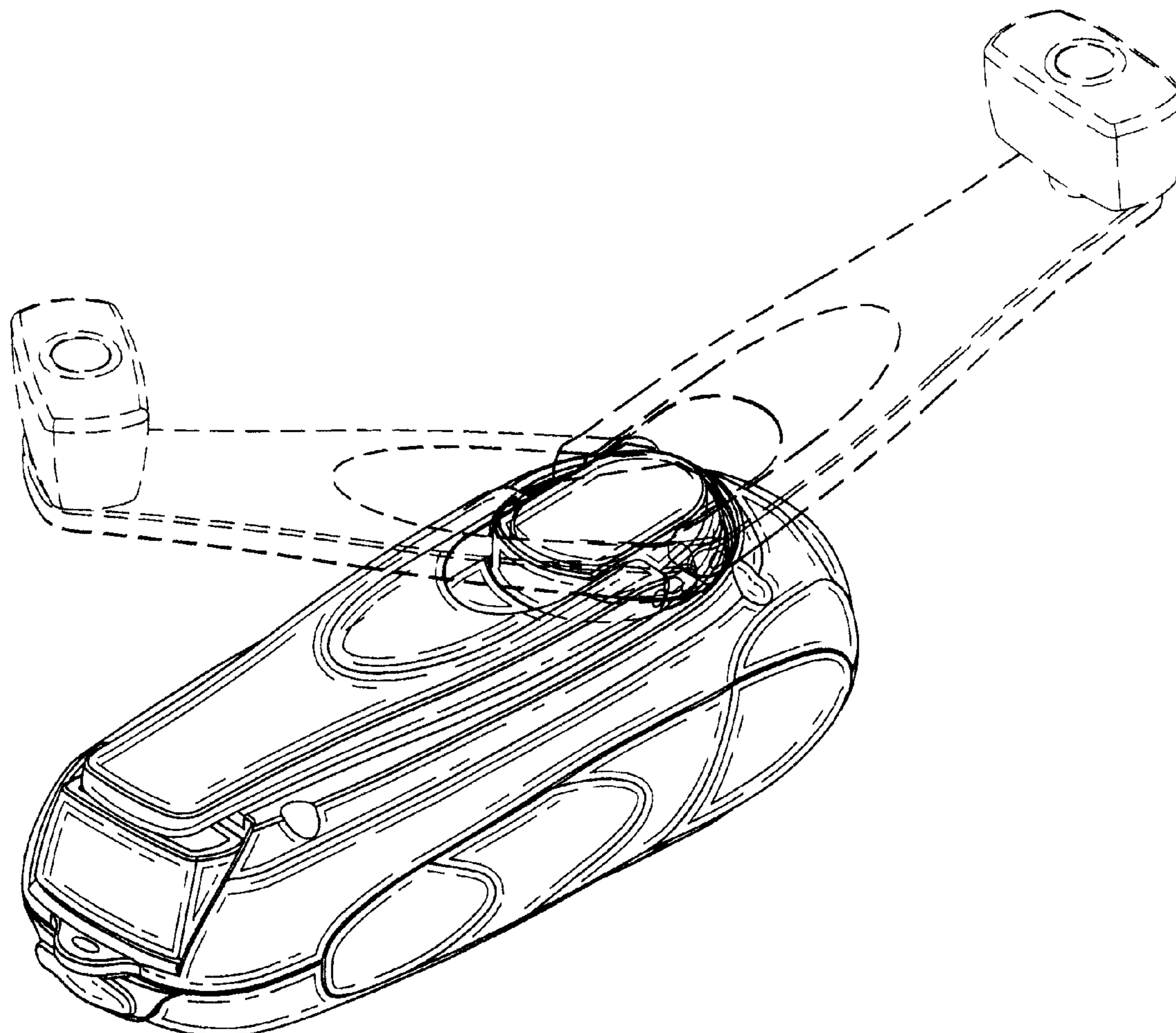

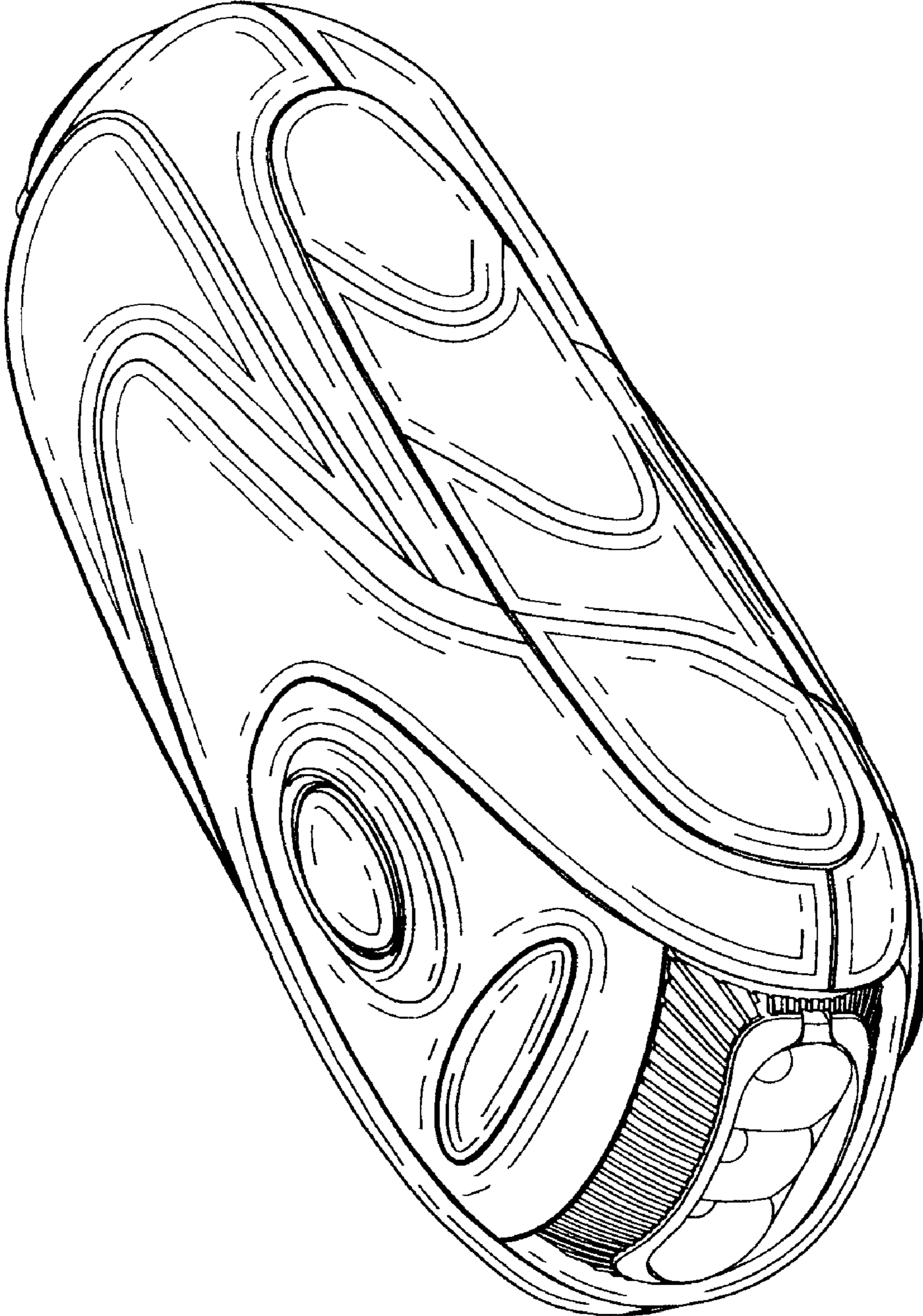

FIG. 1

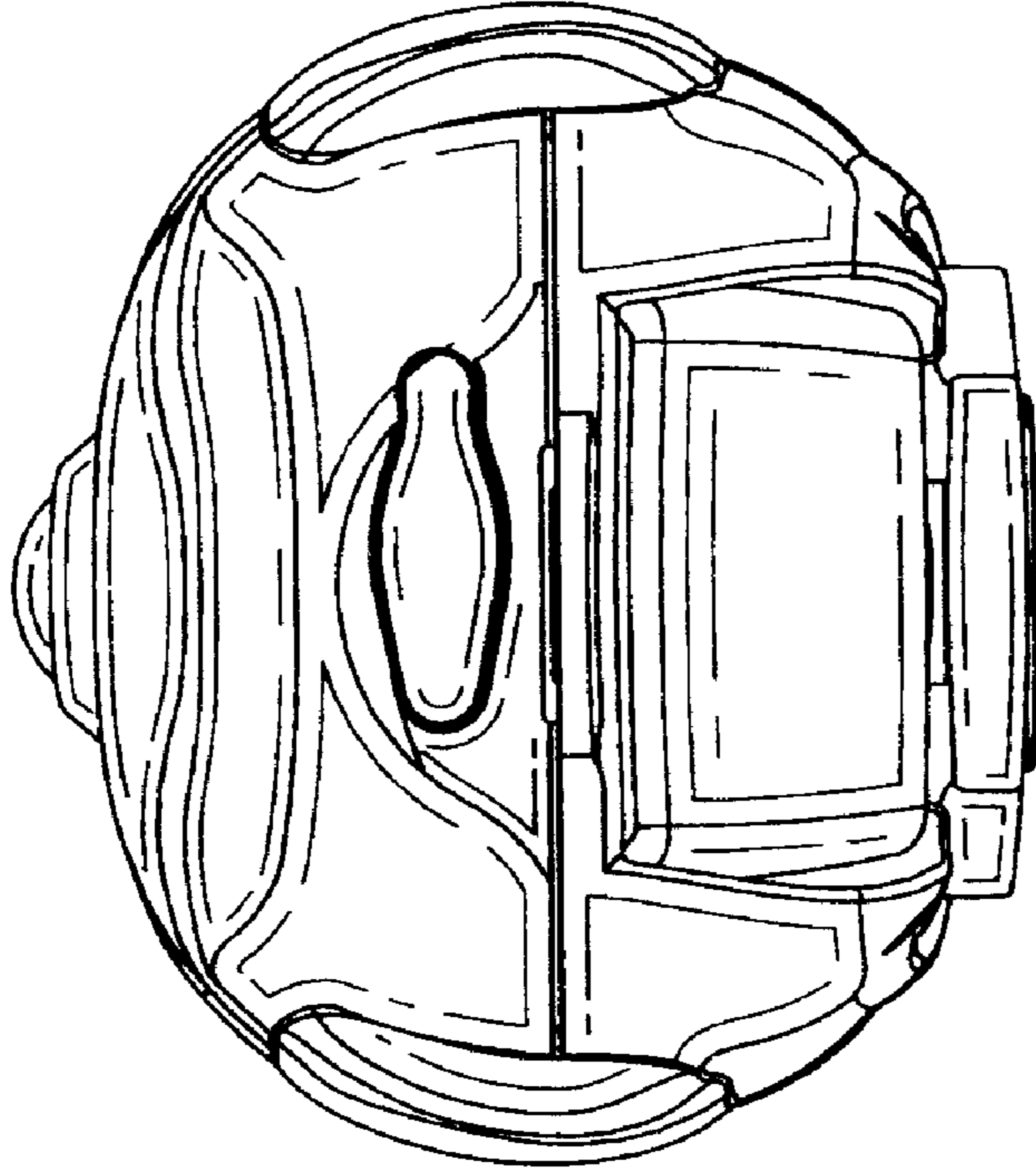

FIG. 3

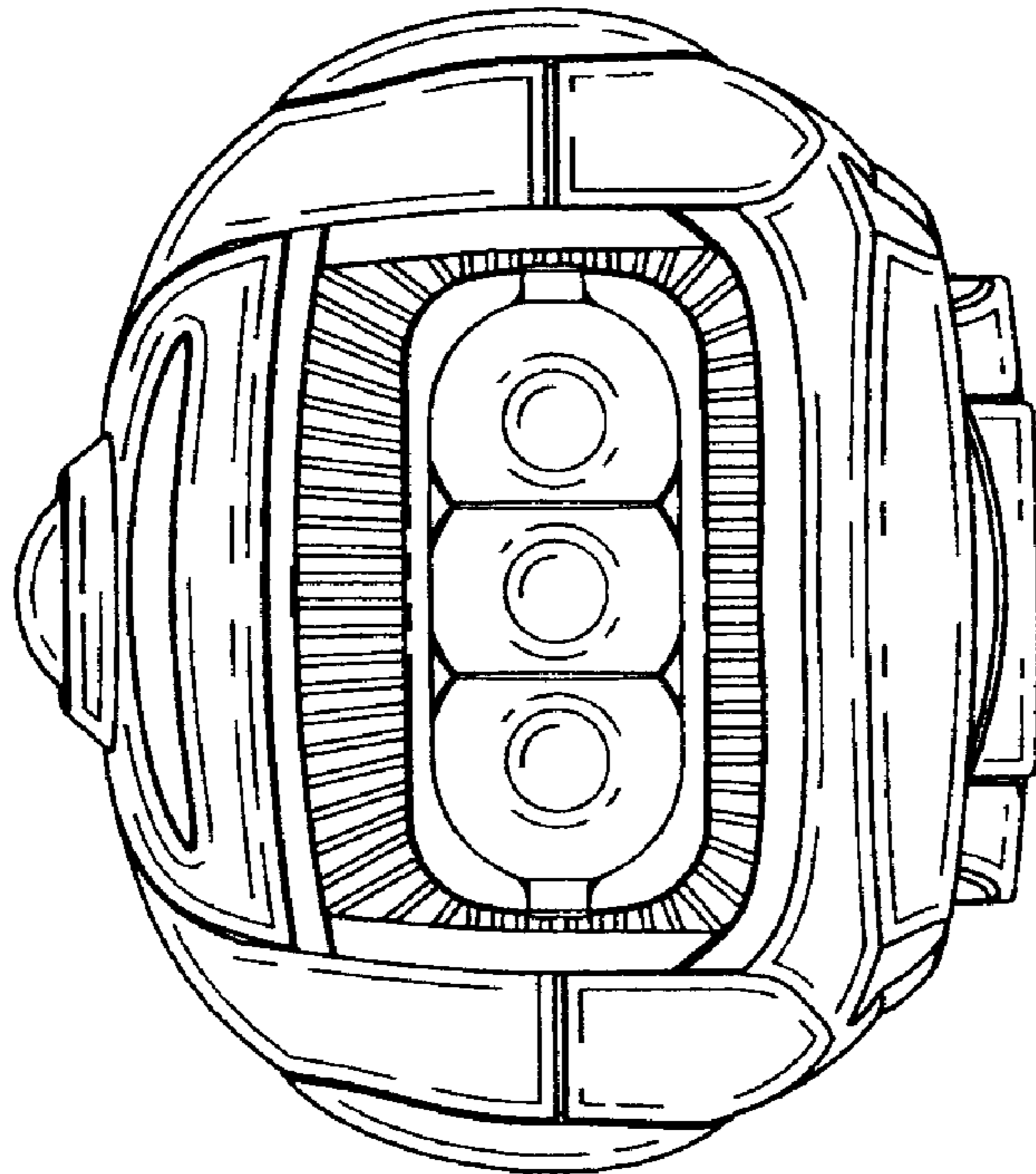

FIG. 2

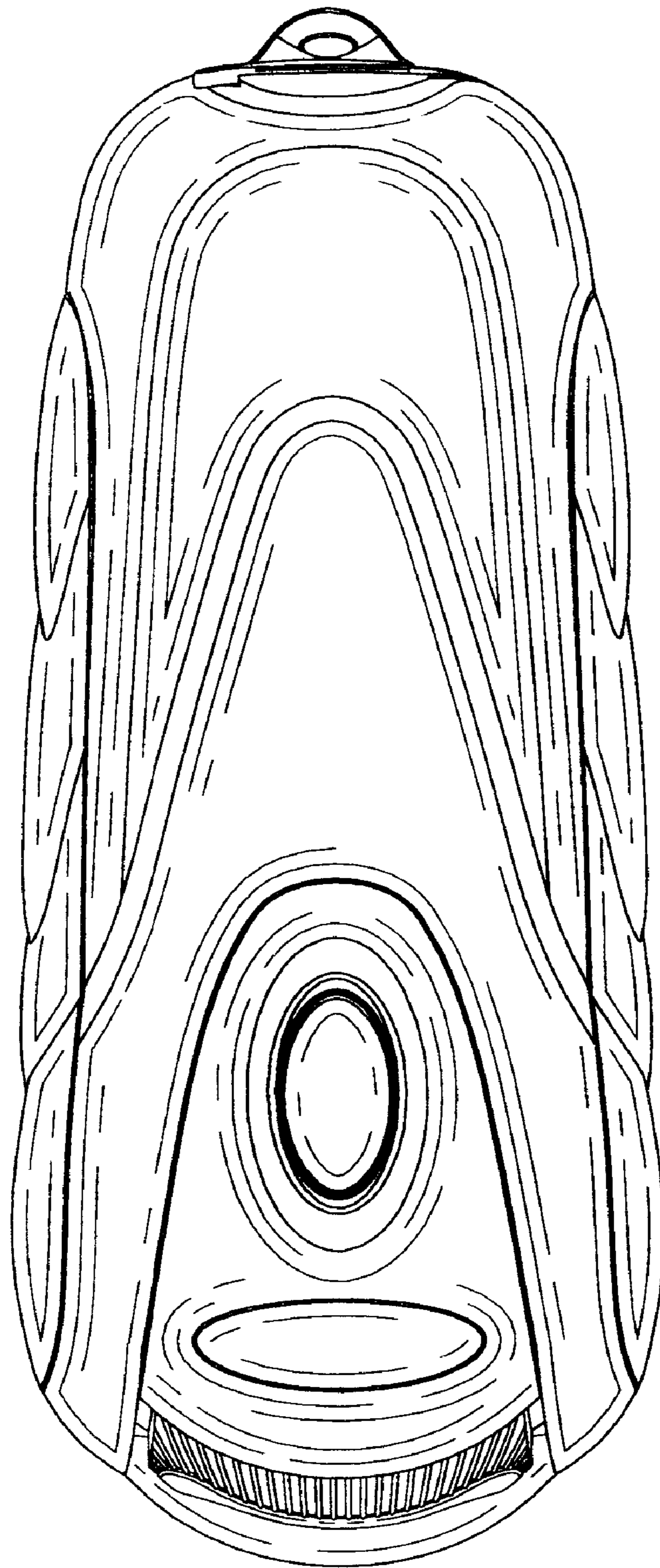

FIG. 4

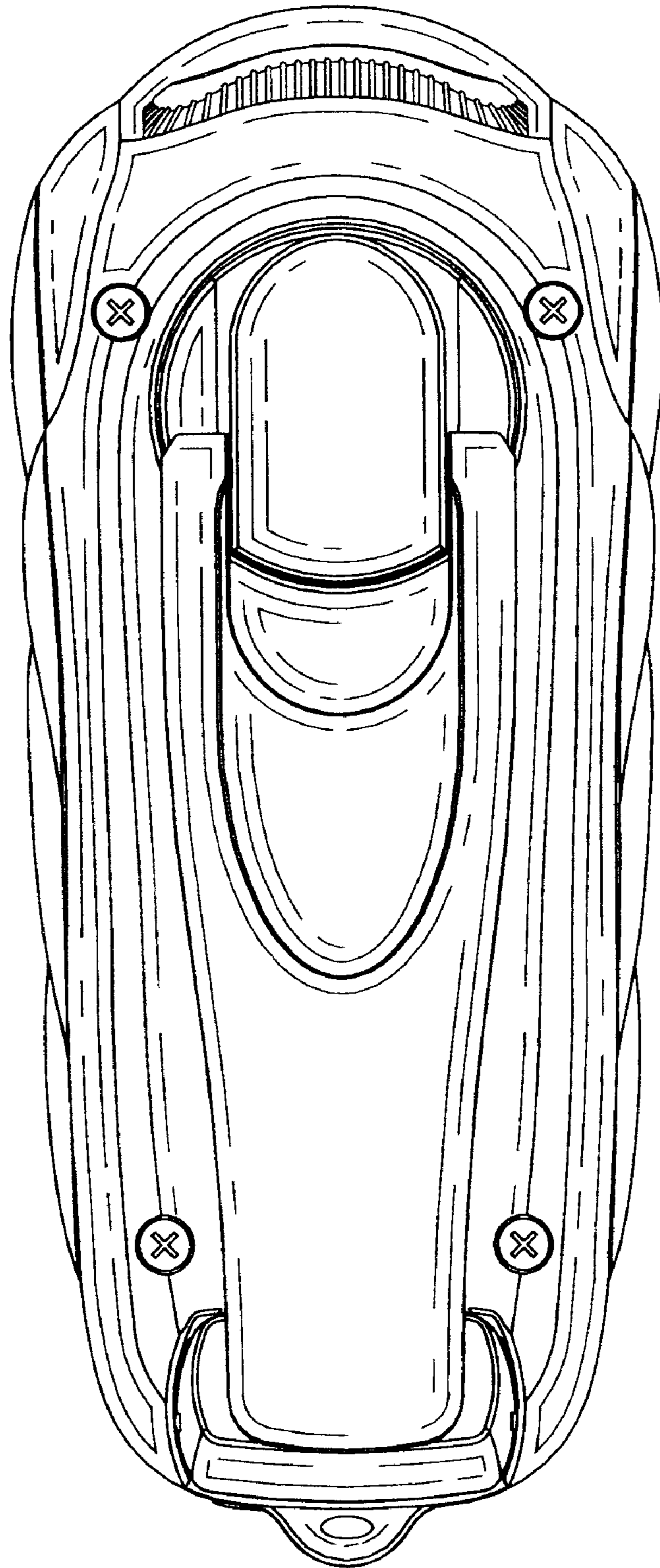

FIG. 5

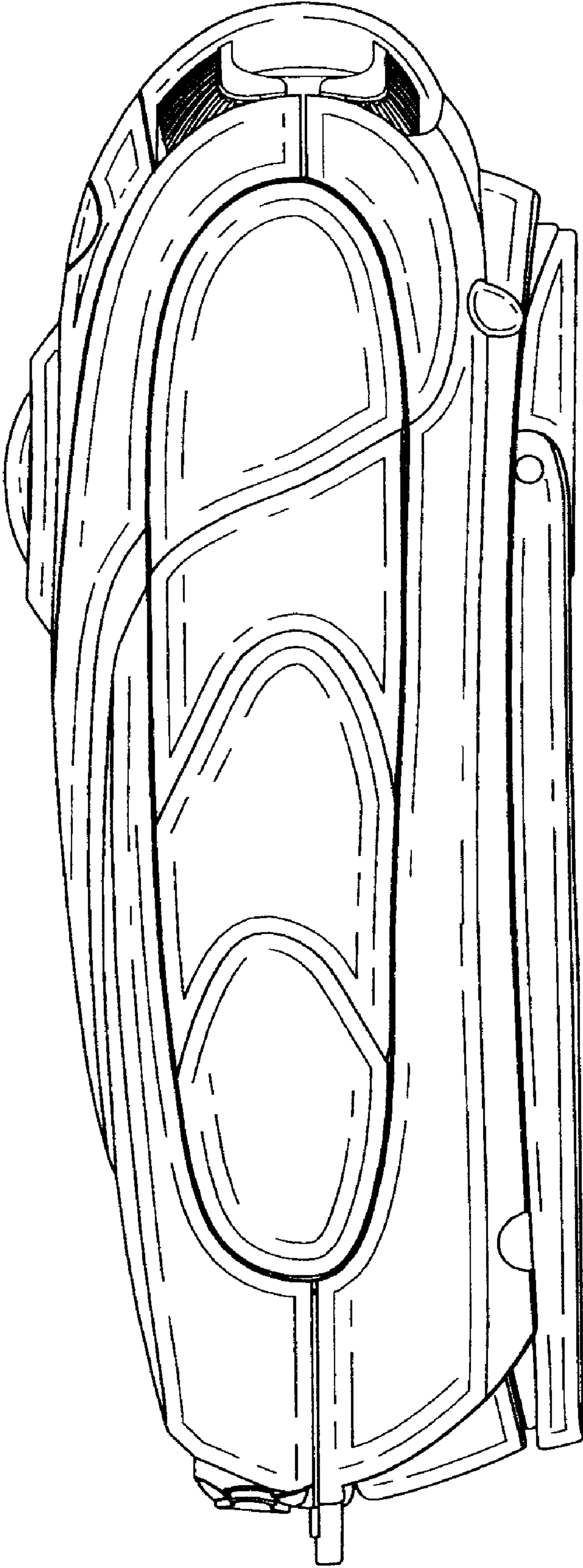

FIG. 6

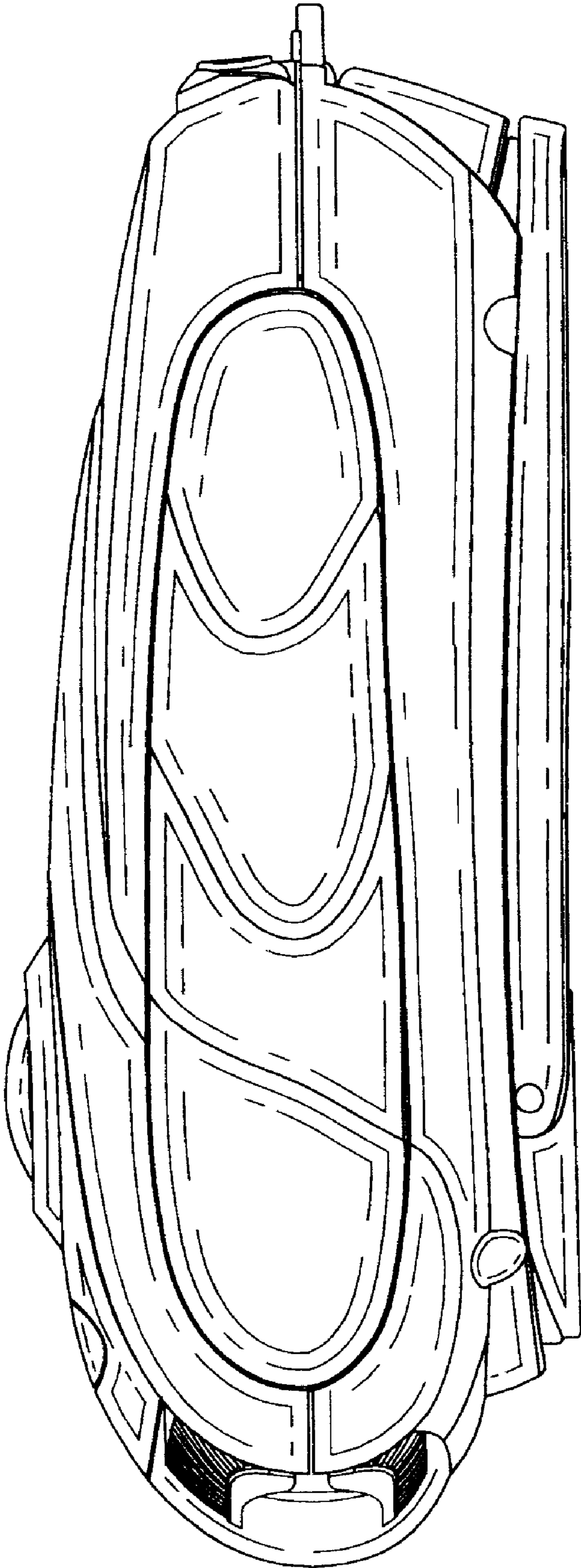

FIG. 7

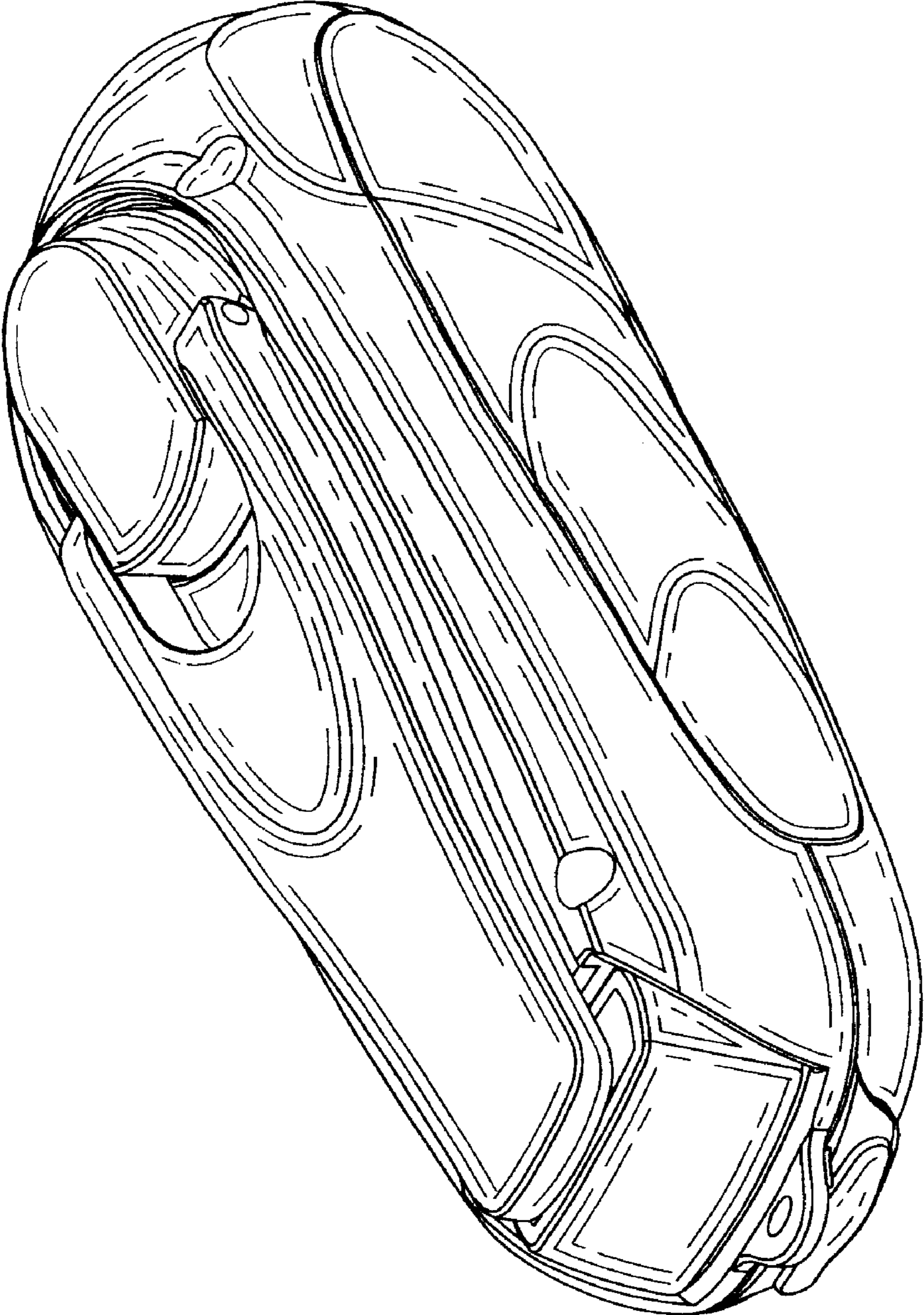

FIG. 8



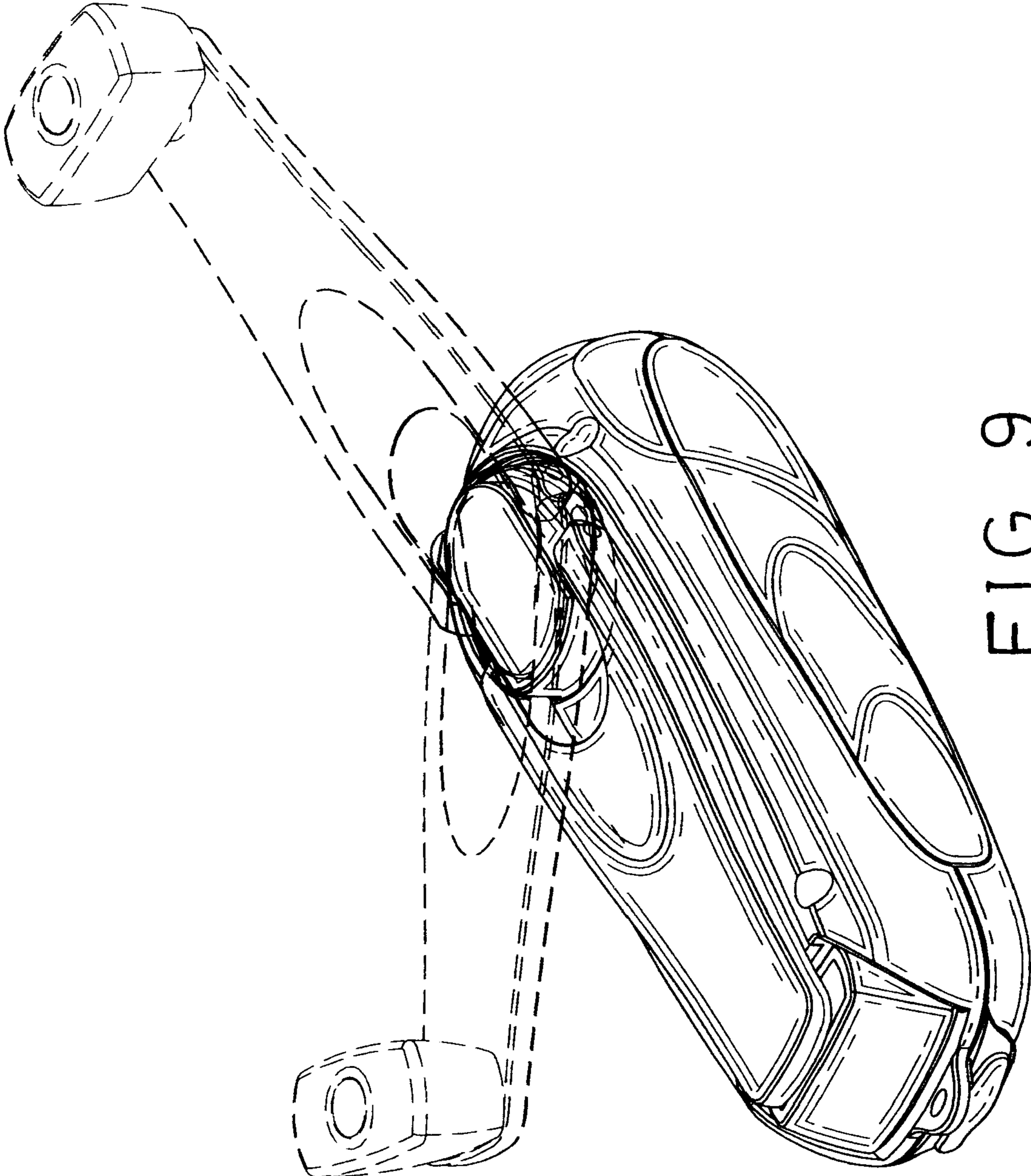

FIG. 9