



US00D519221S

(12) **United States Design Patent**
Otto et al.

(10) **Patent No.:** **US D519,221 S**
(45) **Date of Patent:** **** Apr. 18, 2006**

(54) **FRONT LIGHT TO AN AUTOMOBILE**

D497,682 S * 10/2004 Lin D26/28
D501,265 S * 1/2005 Lin D26/28
D504,735 S * 5/2005 Lin D26/28
D506,016 S * 6/2005 Chiang D26/28

(75) Inventors: **Henrik Otto**, Göteborg (SE); **Fedde Talsma**, Rotterdam (NL); **Alsed Briscoe**, Göteborg (SE)

* cited by examiner

(73) Assignee: **Ford Global Technologies, LLC**, Dearborn, MI (US)

Primary Examiner—Marcus A. Jackson
(74) *Attorney, Agent, or Firm*—Albihns Stockholm AB

(**) Term: **14 Years**

(57) **CLAIM**

(21) Appl. No.: **29/197,719**

The ornamental design for a front light to an automobile, as shown and described.

(22) Filed: **Jan. 21, 2004**

(30) **Foreign Application Priority Data**

DESCRIPTION

Jul. 25, 2003 (SE) 03-0700

FIG. 1 is a front elevational view, according to our new design;

(51) **LOC (8) Cl.** **26-06**

FIG. 2 is a rear elevational view thereof;

(52) **U.S. Cl.** **D26/28**

FIG. 3 is a right side elevational view thereof;

(58) **Field of Classification Search** D26/28-36;
362/459-468, 475-478, 485-487

FIG. 4 is a left side elevational view thereof;

See application file for complete search history.

FIG. 5 is a right side perspective view thereof; and,

FIG. 6 is left side elevational view thereof.

(56) **References Cited**

U.S. PATENT DOCUMENTS

D495,813 S * 9/2004 Lin D26/28

1 Claim, 6 Drawing Sheets

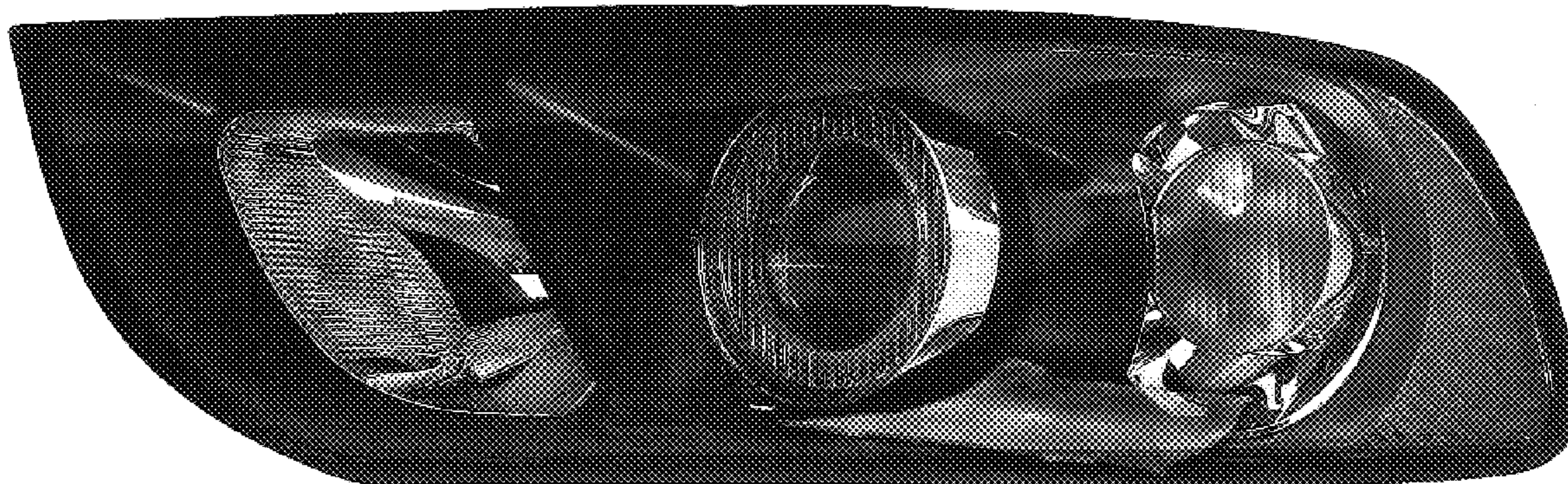

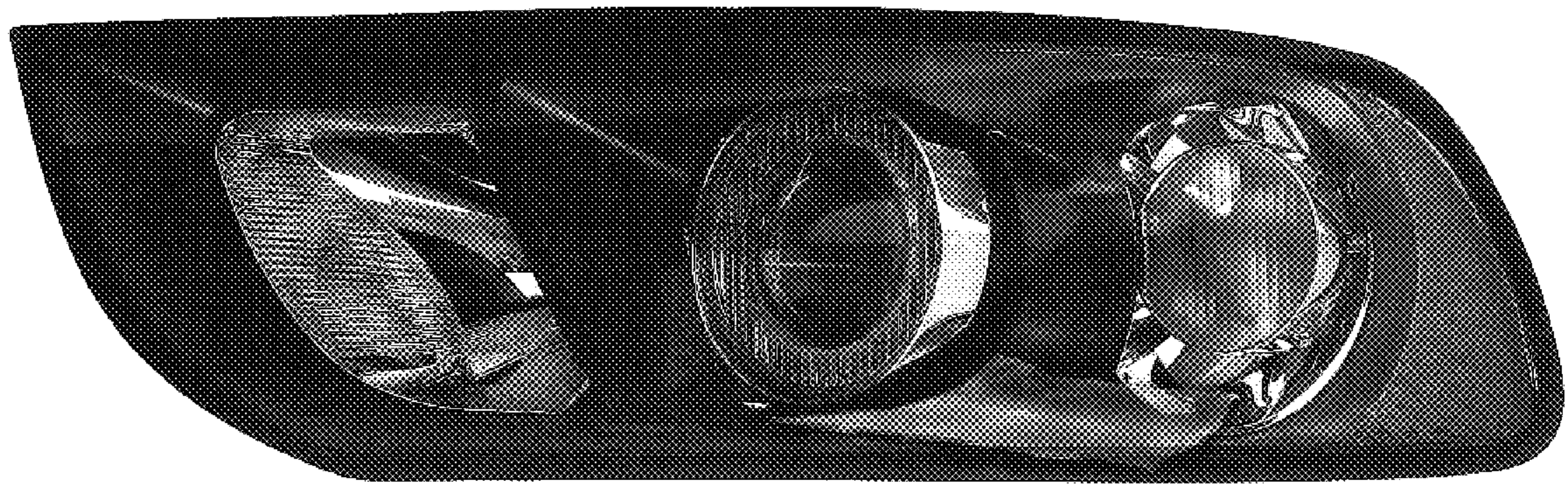

FIG. 1

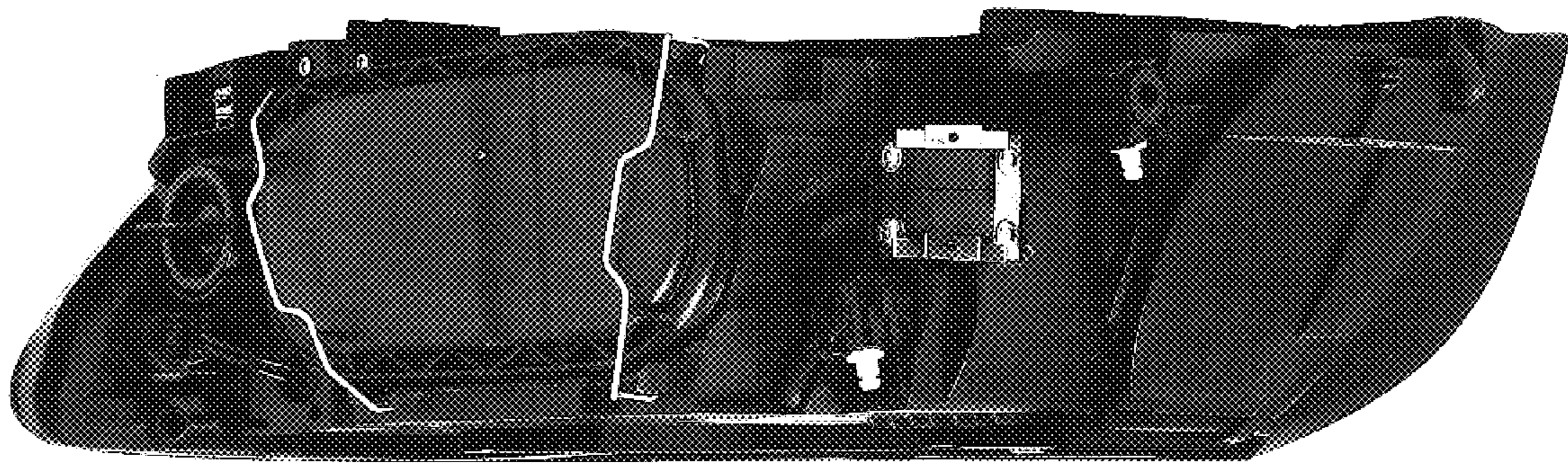

FIG.2

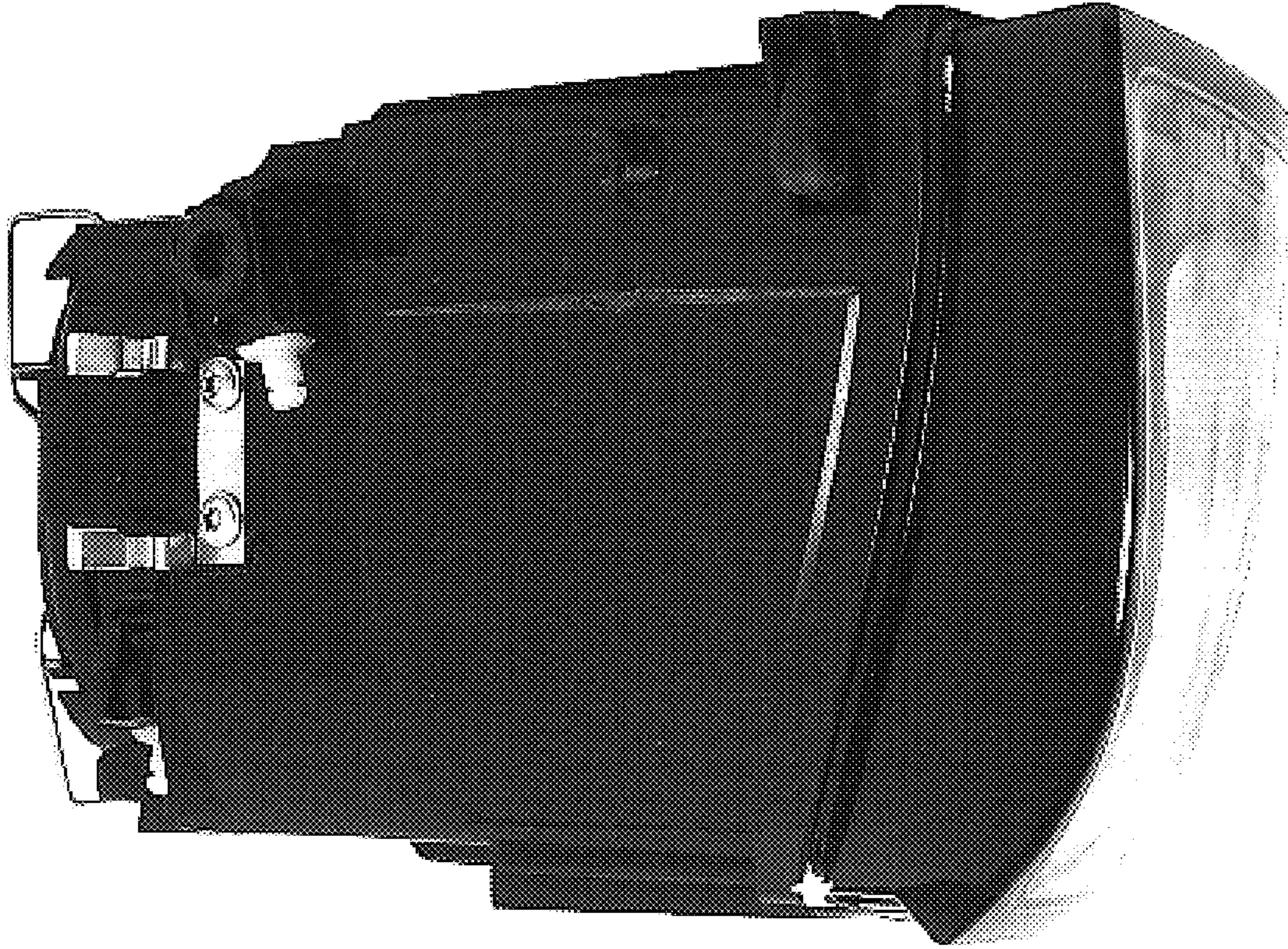

FIG. 3

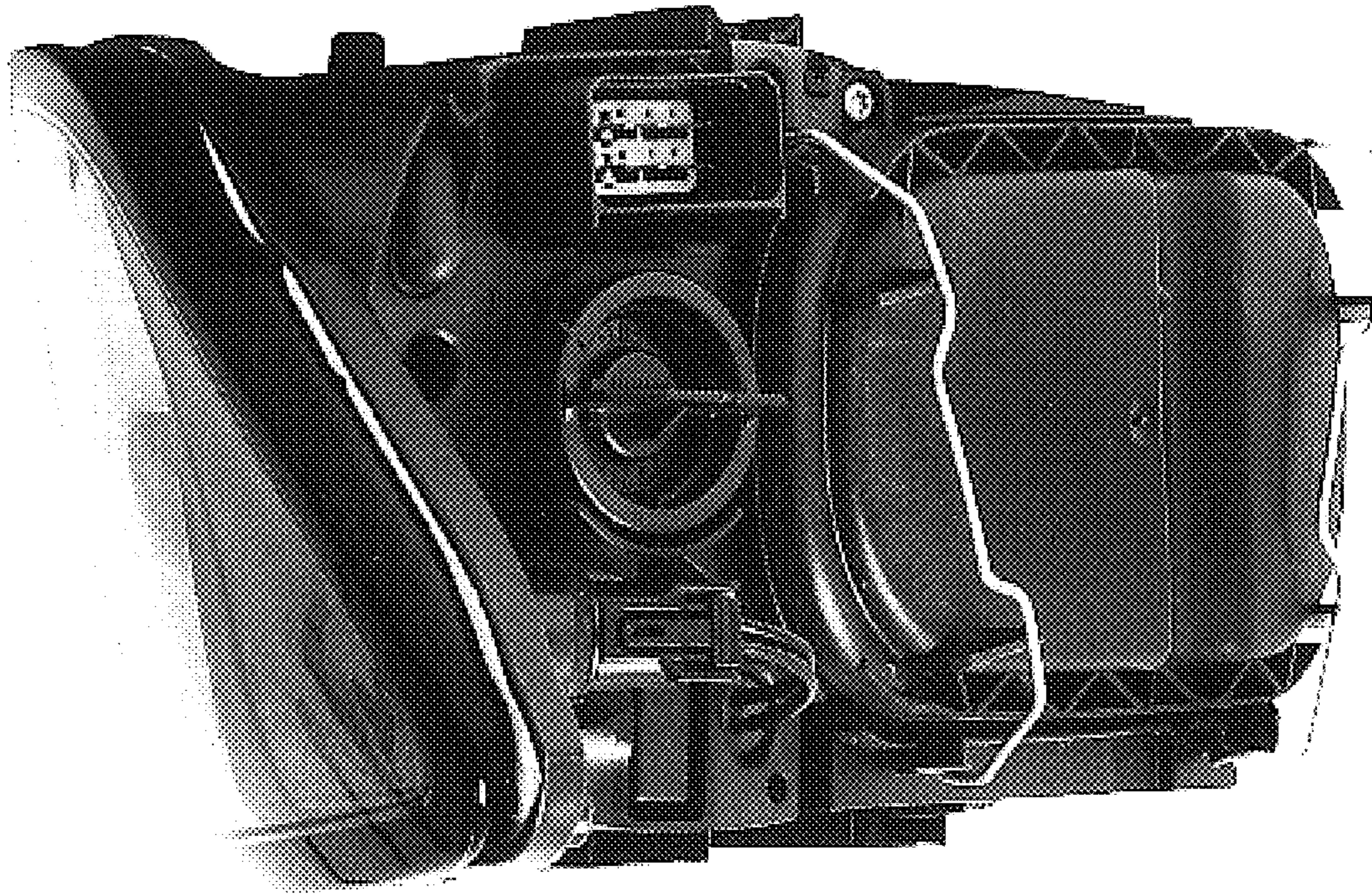

FIG.4

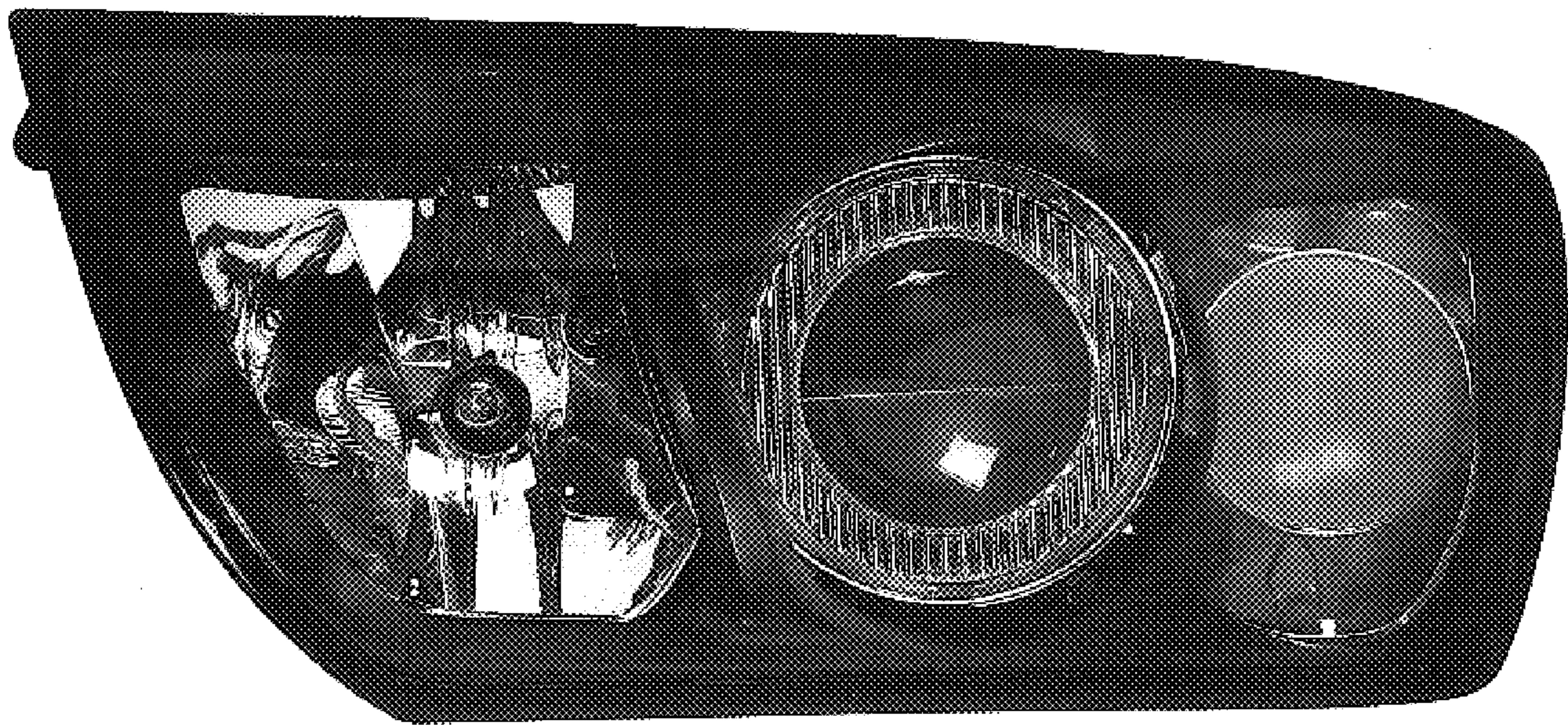

FIG. 5

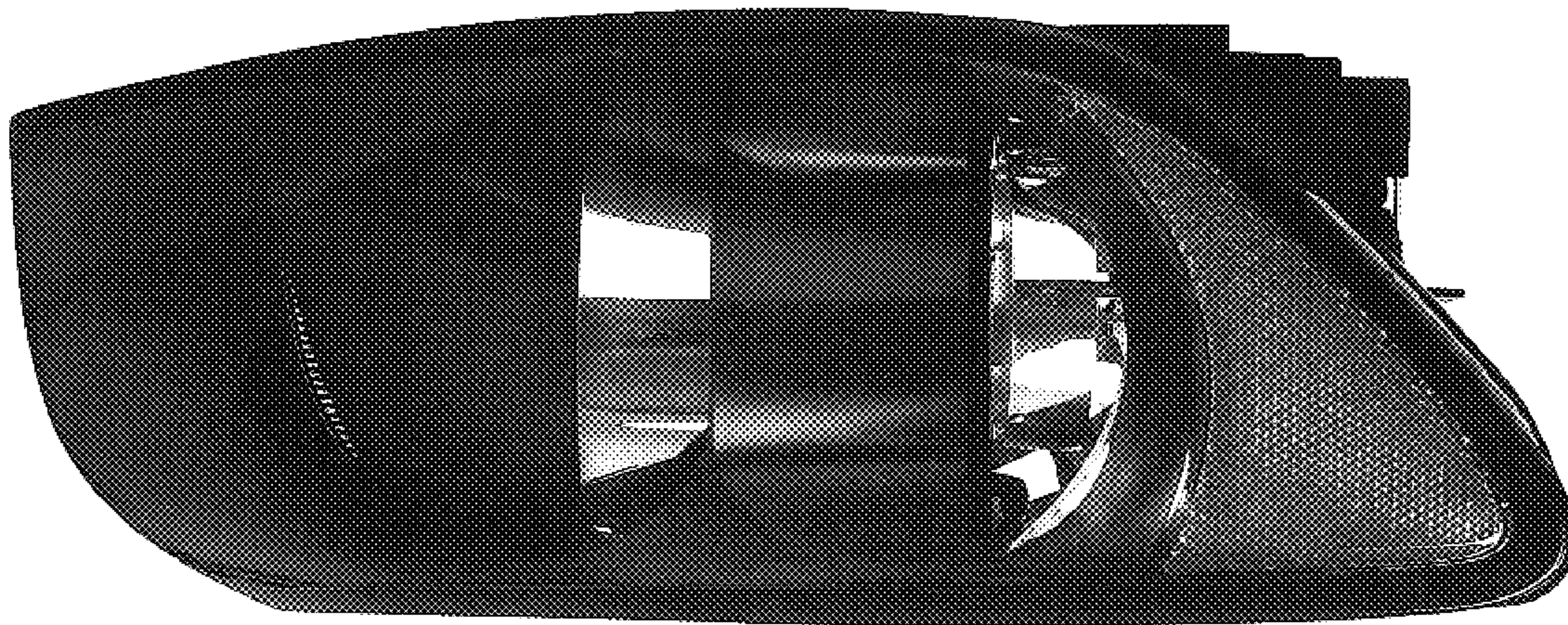

FIG.6