



US00D519220S

(12) **United States Design Patent**
Gulbrandsen

(10) **Patent No.:** **US D519,220 S**

(45) **Date of Patent:** **** Apr. 18, 2006**

(54) **WIRE WEAVE CEILING PANEL**

(75) Inventor: **Peder Gulbrandsen**, Aurora, IL (US)

(73) Assignee: **USG Interiors, Inc.**, Chicago, IL (US)

(**) Term: **14 Years**

(21) Appl. No.: **29/221,551**

(22) Filed: **Jan. 18, 2005**

(51) **LOC (8) Cl.** **25-01**

(52) **U.S. Cl.** **D25/153**

(58) **Field of Classification Search** D25/163,
D25/152, 58, 150, 157, 153, 156; 52/434,
52/764, 507, 506.06, 506.04, 311.3, 342,
52/343, 646, 650.3, 656.8; 428/221, 222
See application file for complete search history.

(56) **References Cited**

U.S. PATENT DOCUMENTS

D260,040 S	*	7/1981	Maresca	D25/152
D270,094 S	*	8/1983	Thual	D25/154
5,174,090 A	*	12/1992	Teli et al.	52/506.06
D360,700 S	*	7/1995	Myers et al.	D25/153

* cited by examiner

Primary Examiner—Doris Clark

(74) *Attorney, Agent, or Firm*—Pearne & Gordon LLP

(57) **CLAIM**

The ornamental design for a wire weave ceiling panel, as shown and described.

DESCRIPTION

FIG. 1 is a top perspective view of a wire weave ceiling panel, showing my new design;

FIG. 2 is a bottom perspective view thereof, the broken line showing of a suspended ceiling grid is for the purpose of illustrating the environment and forms no part of the claimed design;

FIG. 3 is a top view thereof;

FIG. 4 is a side elevational view thereof;

FIG. 5 is a side elevational view, adjacent the side of FIG. 4, thereof;

FIG. 6 is a side elevational view from a side opposite FIG. 4;

FIG. 7 is a side elevational view from a side opposite FIG. 5; and,

FIG. 8 is a bottom view thereof.

1 Claim, 3 Drawing Sheets

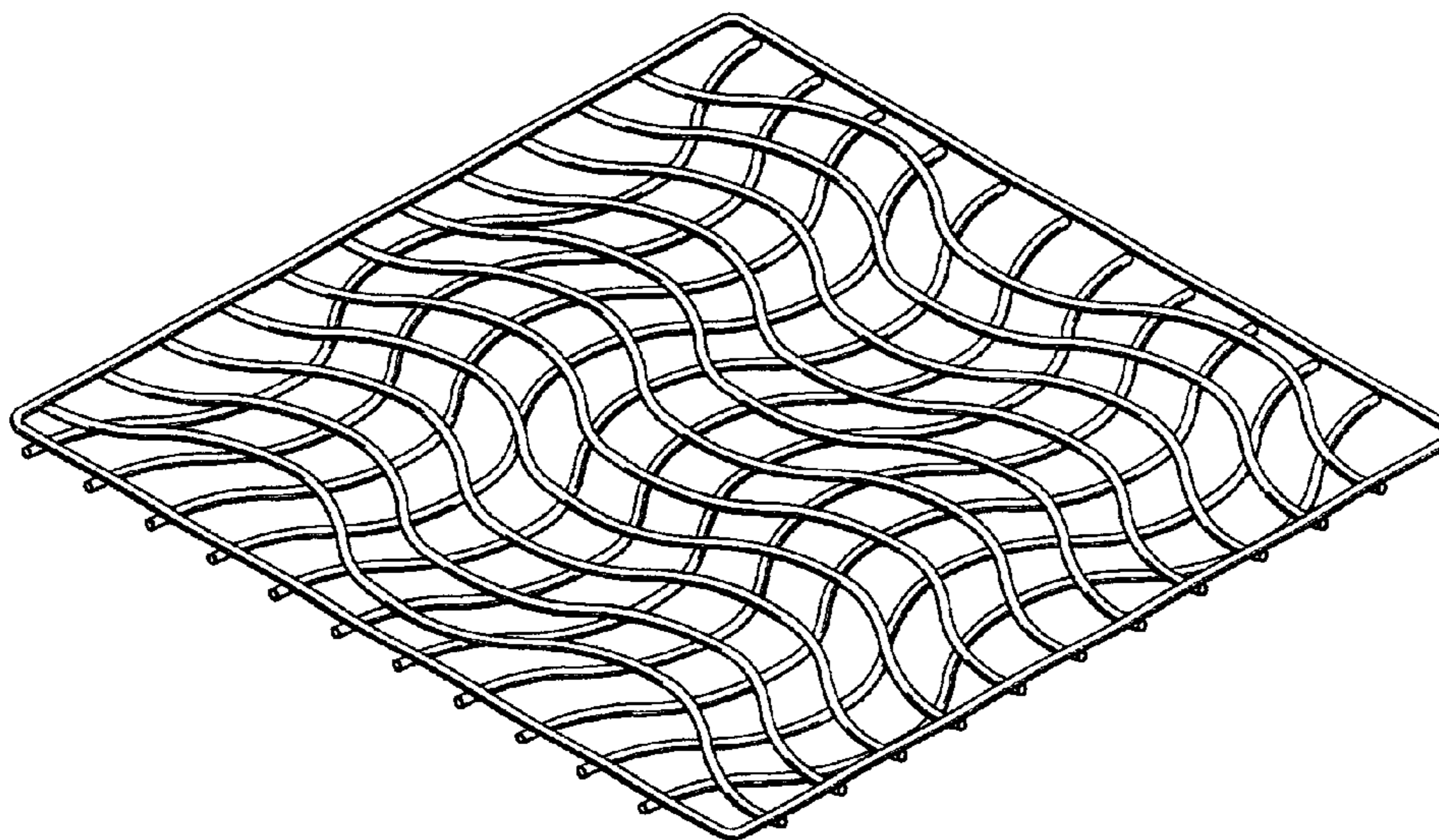

FIG. 1

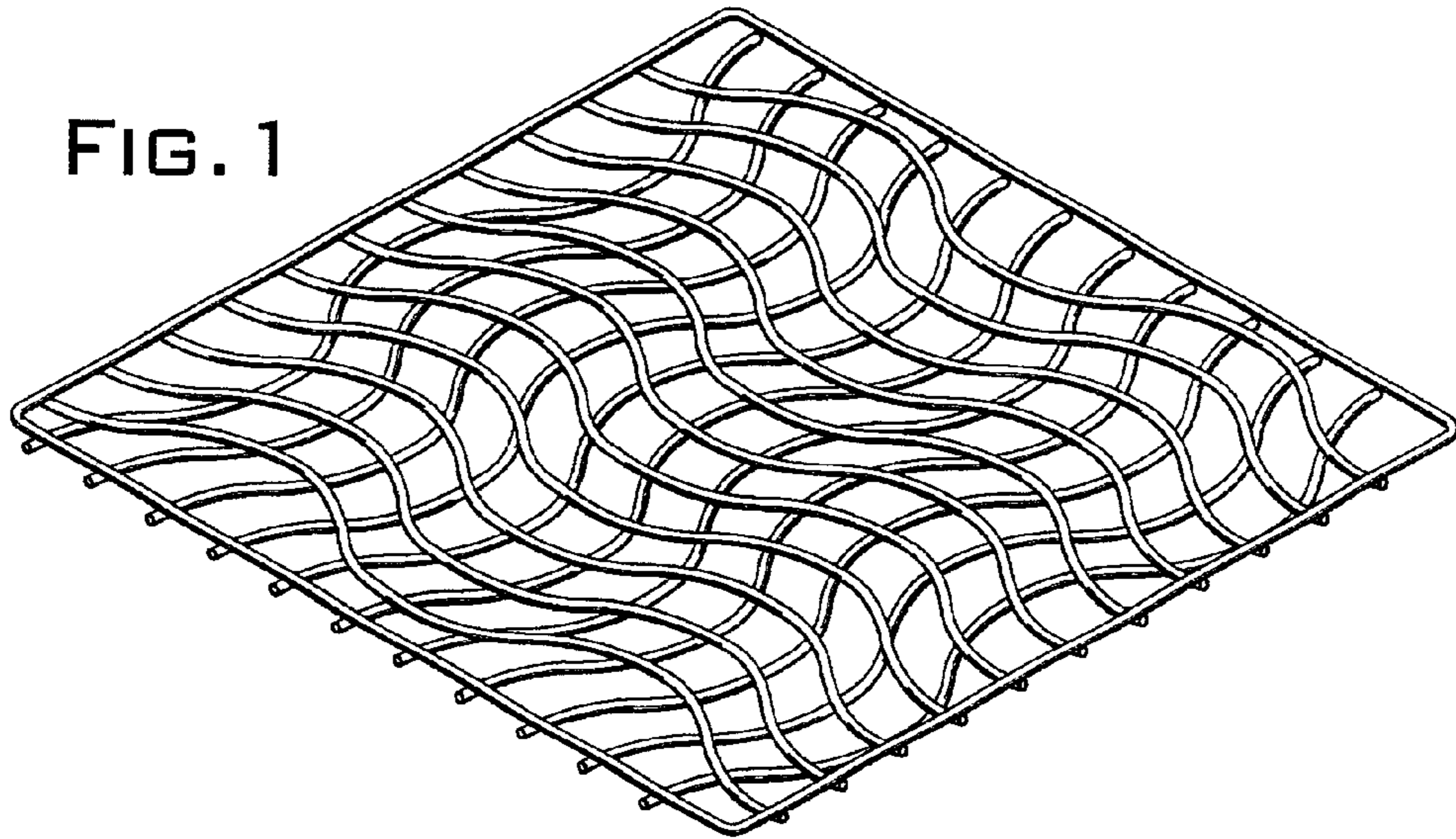
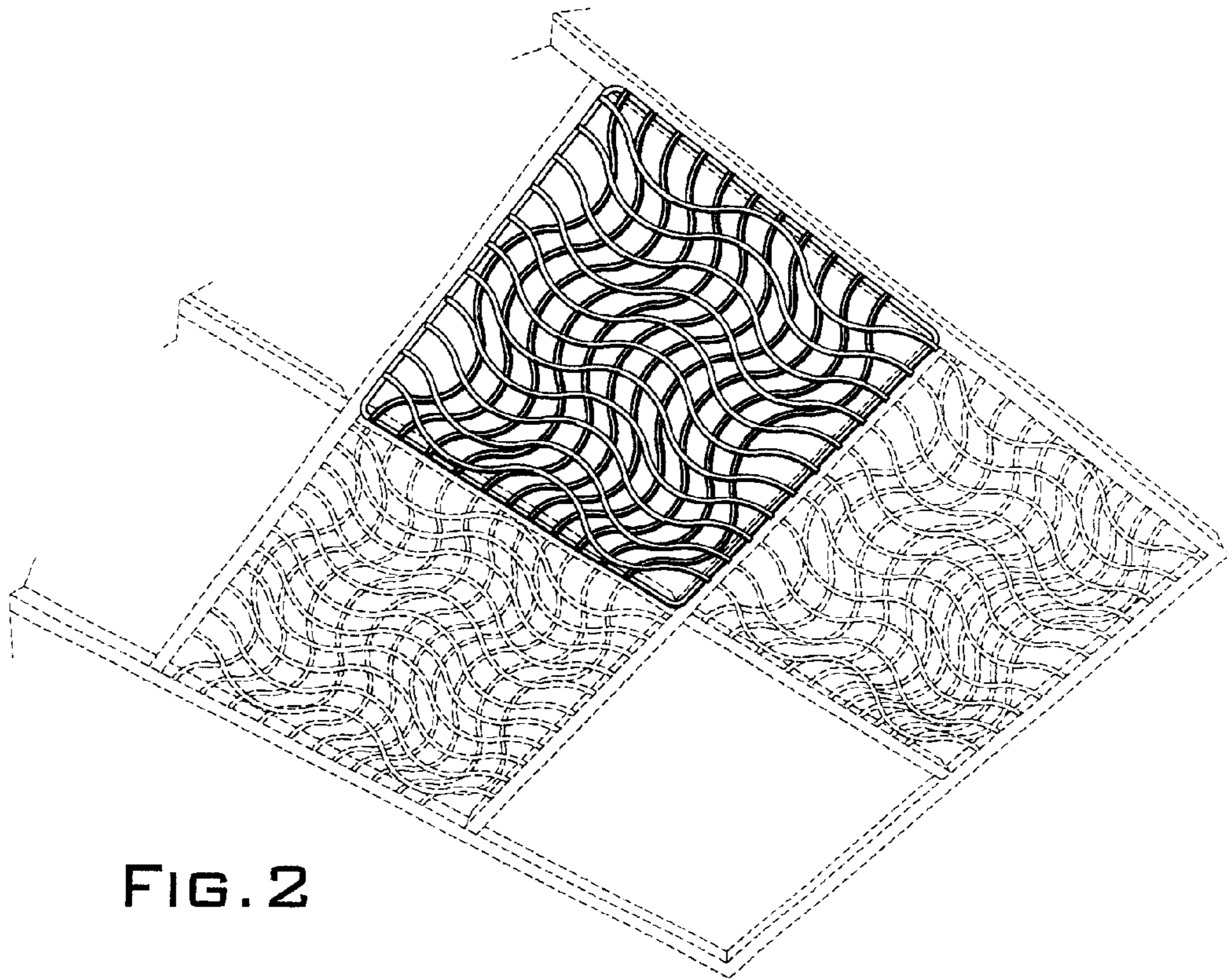

FIG. 2



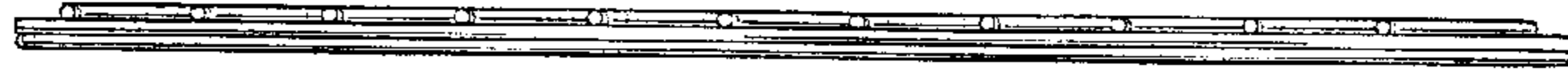

FIG. 5



FIG. 6

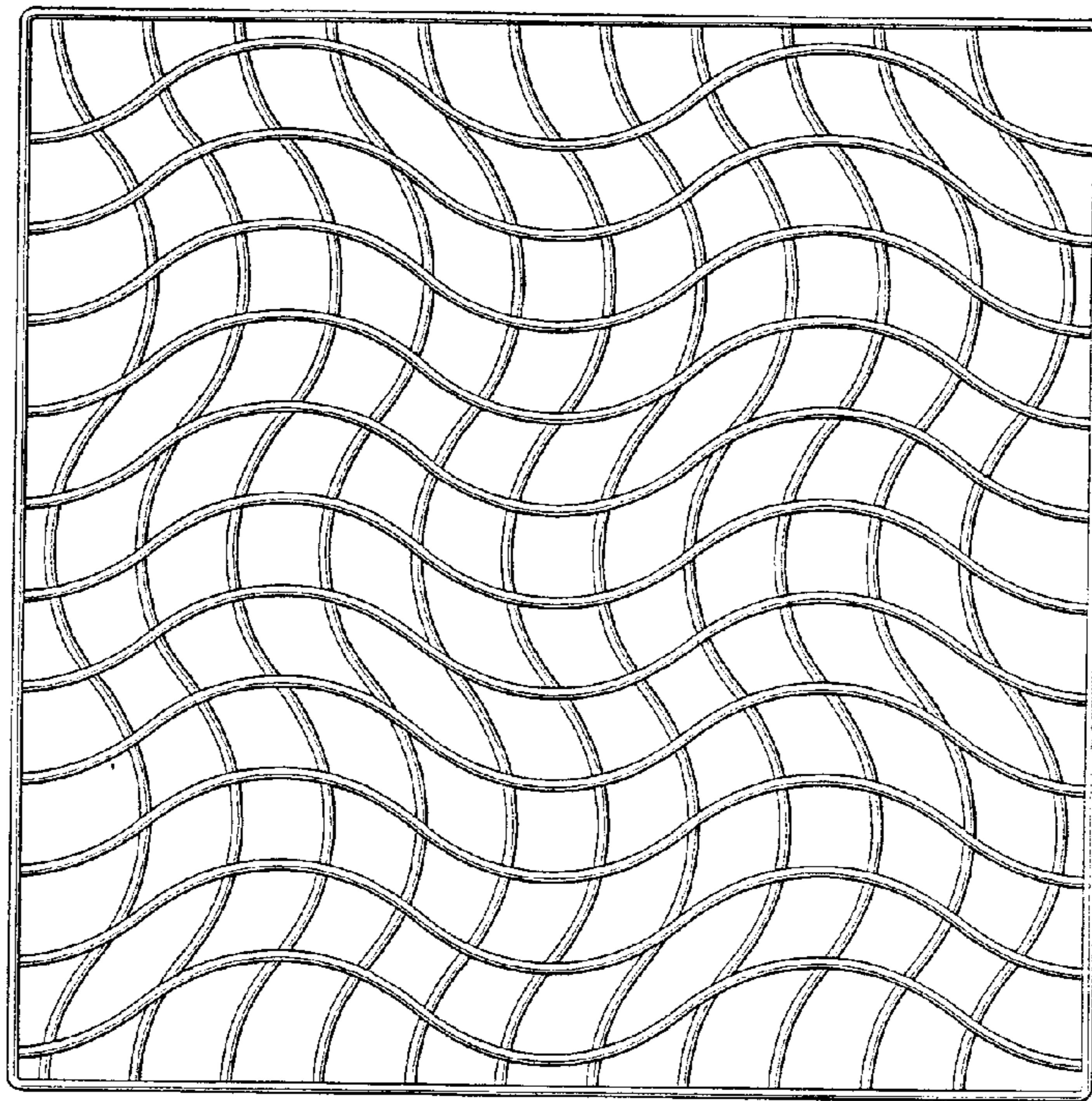

FIG. 3



FIG. 4

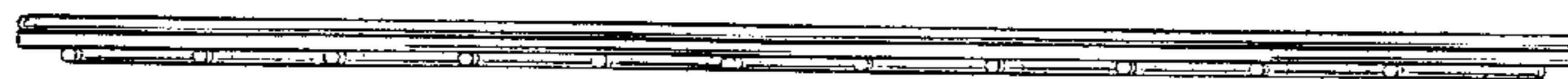

FIG. 7

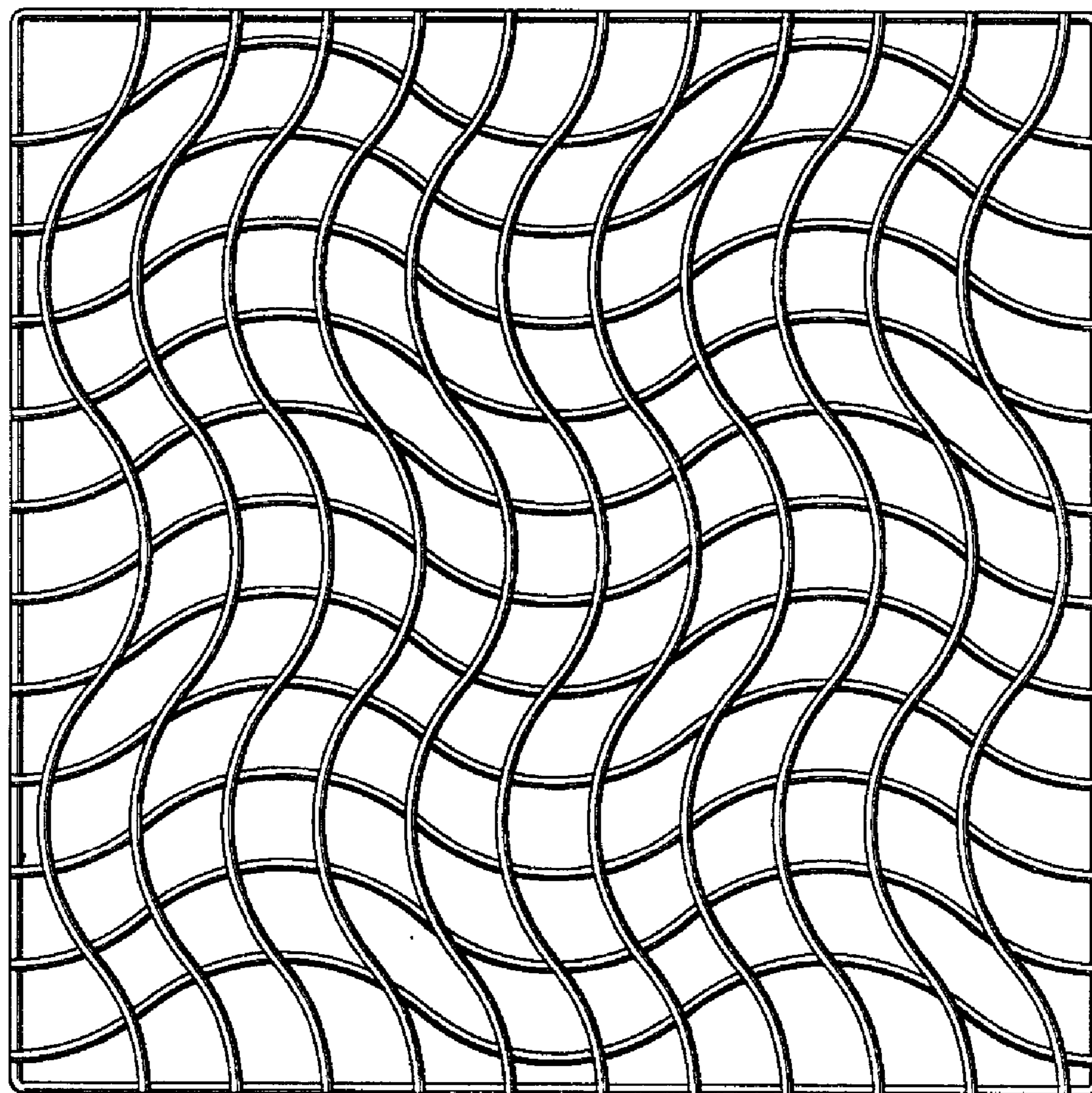

FIG. 8