



US00D519193S

(12) **United States Design Patent**
Chan

(10) **Patent No.:** **US D519,193 S**

(45) **Date of Patent:** **** Apr. 18, 2006**

(54) **BRACKET FOR A SHOWER BAR**

6,123,308 A * 9/2000 Faisst 4/605
D493,864 S * 8/2004 Haug et al. D23/304

(75) Inventor: **Wai Man Chan**, Tsuen Wan (HK)

* cited by examiner

(73) Assignee: **Jing Mei Industrial Holdings Limited**,
Rarotanga (CK)

Primary Examiner—Robert A. Delehanty
(74) *Attorney, Agent, or Firm*—Norris McLaughlin &
Marcus PA

(**) Term: **14 Years**

(21) Appl. No.: **29/231,533**

(57) **CLAIM**

(22) Filed: **Jun. 7, 2005**

The ornamental design for a bracket for a shower bar, as shown and described.

Related U.S. Application Data

DESCRIPTION

(62) Division of application No. 29/222,154, filed on Jan. 26, 2005.

FIG. 1 is a perspective view of the front of a bracket for a shower bar;

(51) **LOC (8) Cl.** **23-02**

FIG. 2 is an elevation view of the front thereof;

(52) **U.S. Cl.** **D23/304**

FIG. 3 is an elevation view of the rear thereof;

(58) **Field of Classification Search** D23/270–271,
D23/275, 283, 303–304; 4/546, 552, 605,
4/596–597, 615, 617, 601; D8/355, 373;
248/229.1

FIG. 4 is an elevation view of a side thereof;

FIG. 5 is a perspective view thereof shown with a complete shower bar (portions not claimed shown with broken lines)

See application file for complete search history.

FIG. 6 is a plan view of the top thereof; and,

FIG. 7 is plan view of the bottom thereof.

The broken line showing a shower bar coupled with the ornamental design in FIG. 5 is for illustrative purposes only and forms no part of the claimed design.

(56) **References Cited**

U.S. PATENT DOCUMENTS

D296,582 S * 7/1988 Haug et al. D23/304

1 Claim, 2 Drawing Sheets

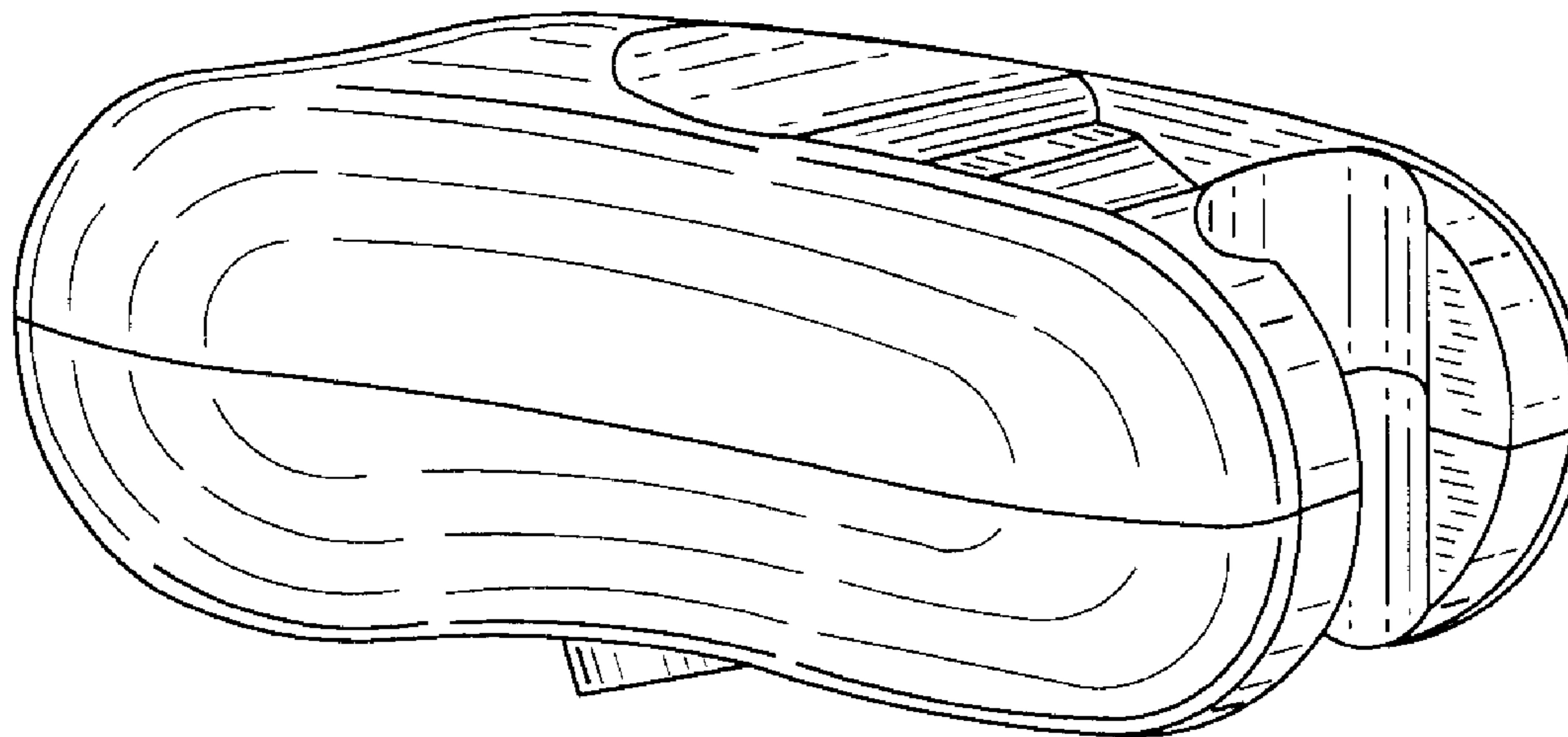

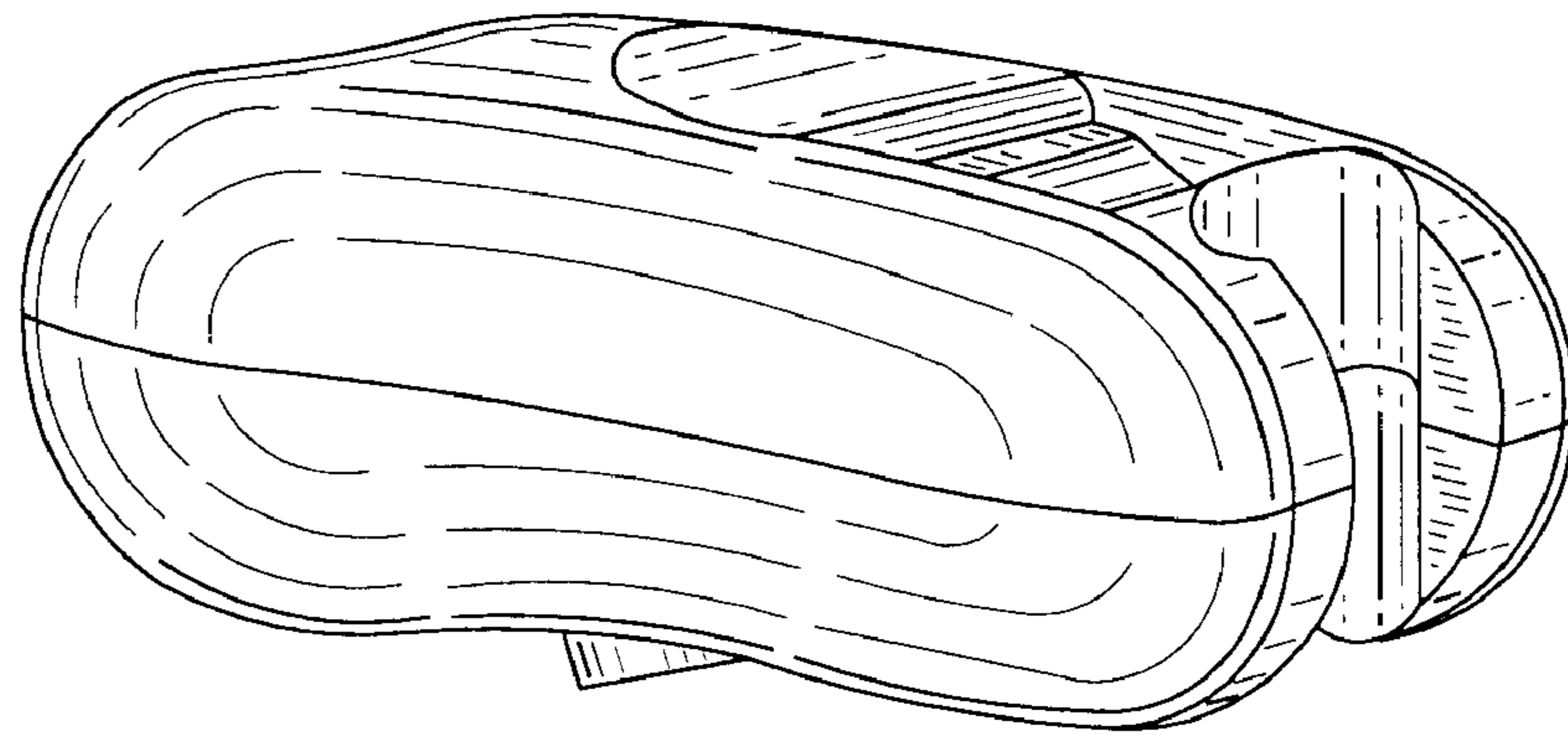

FIG. 1

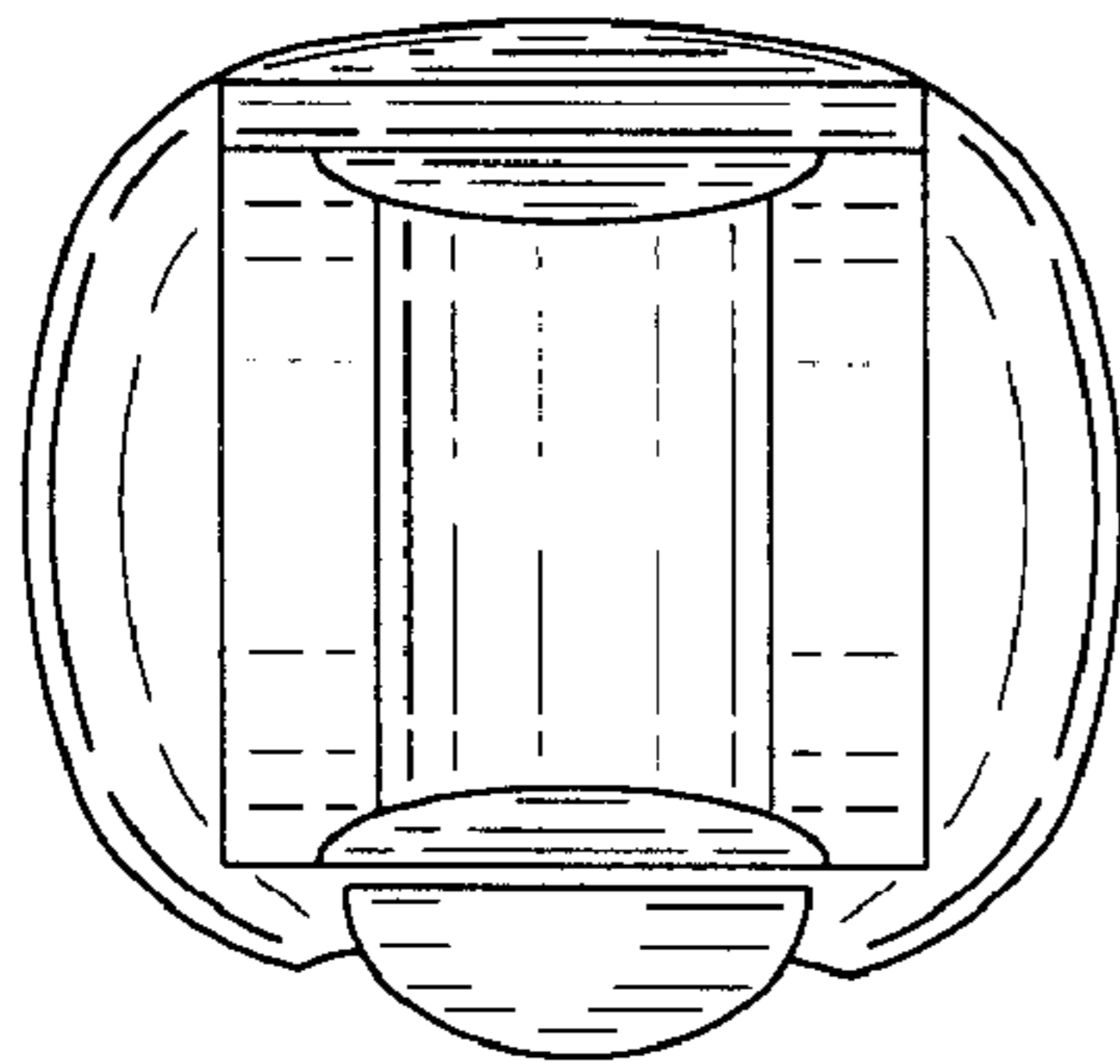

FIG. 2

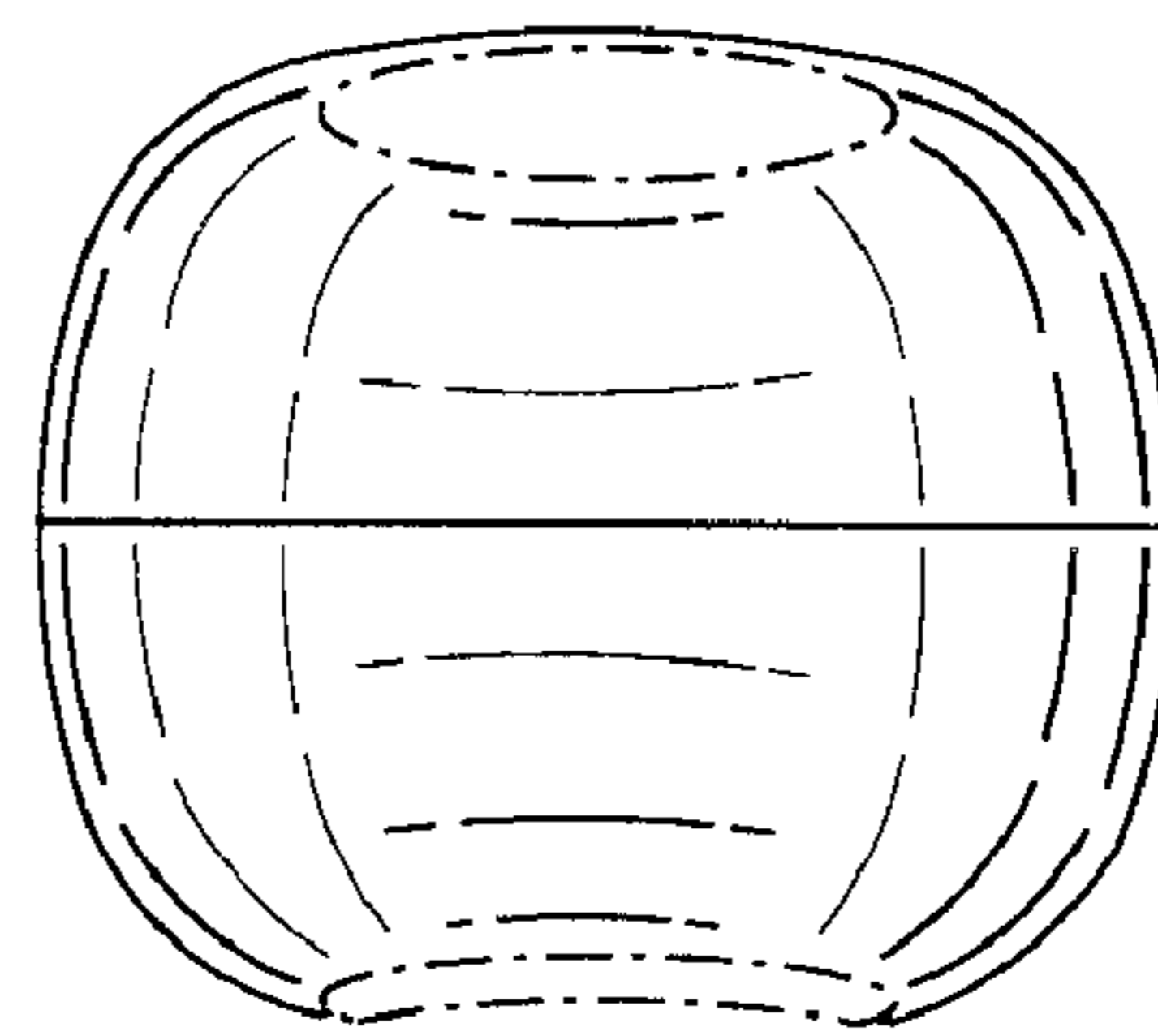

FIG. 3

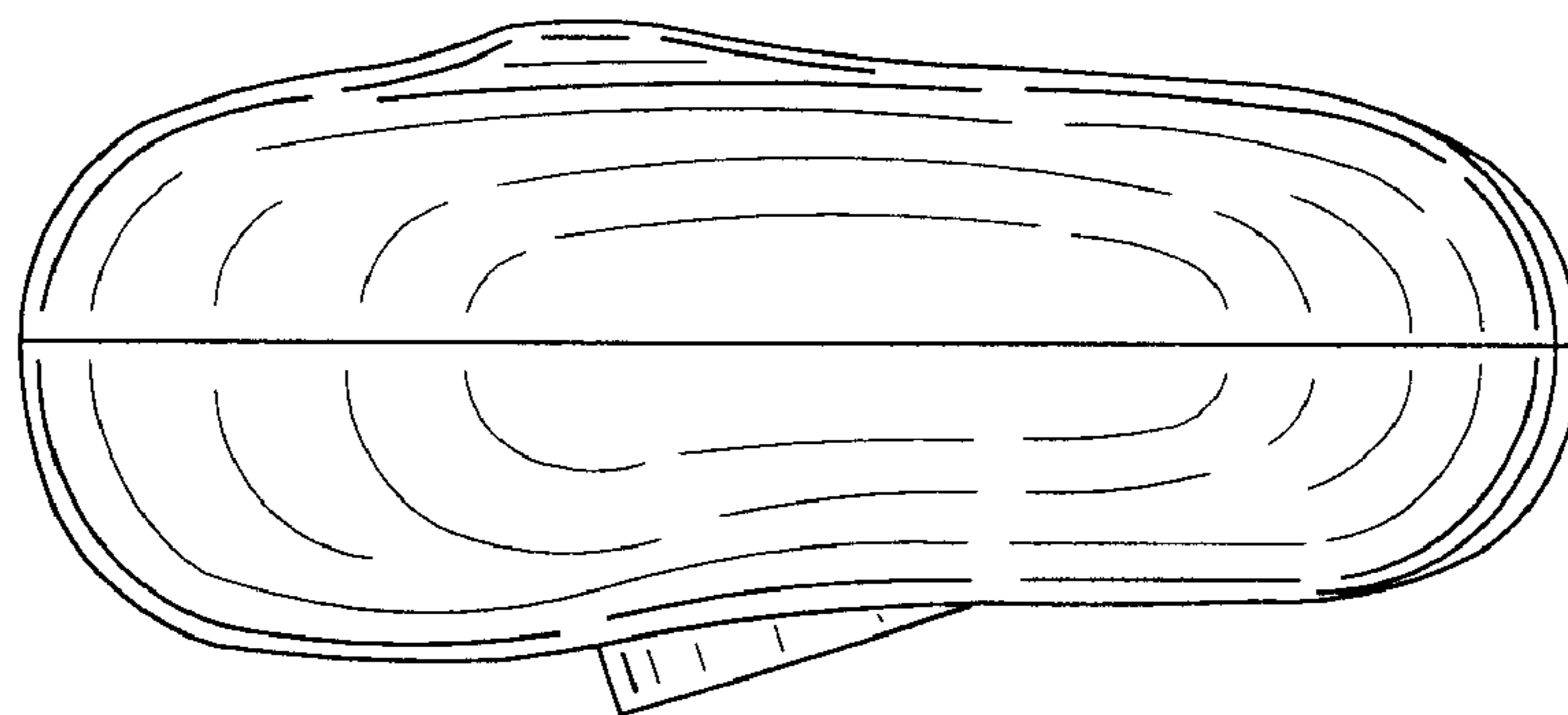

FIG. 4

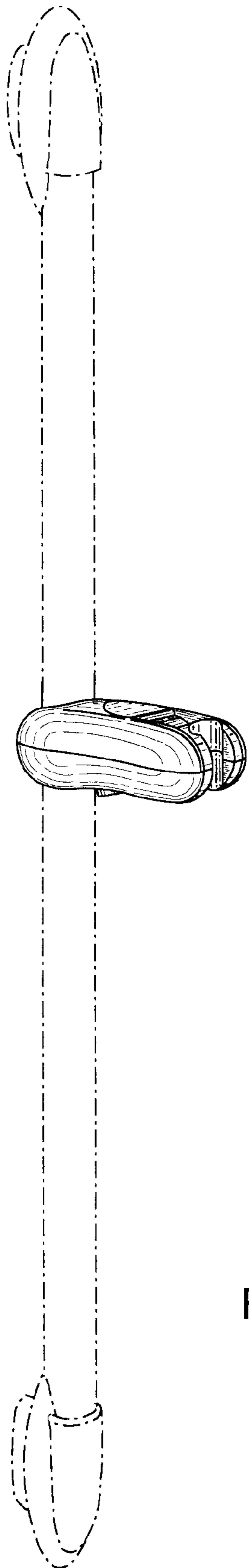

FIG. 5

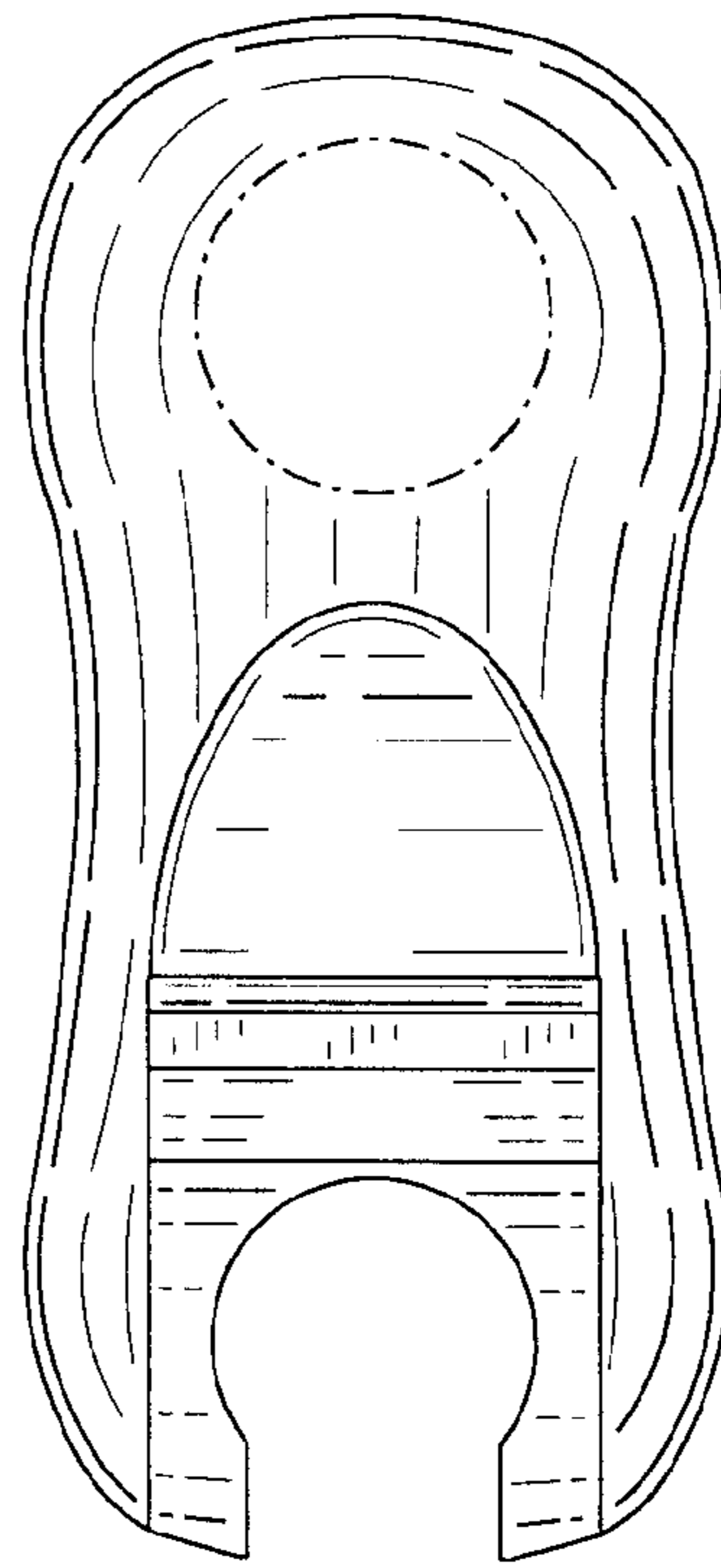

FIG. 6

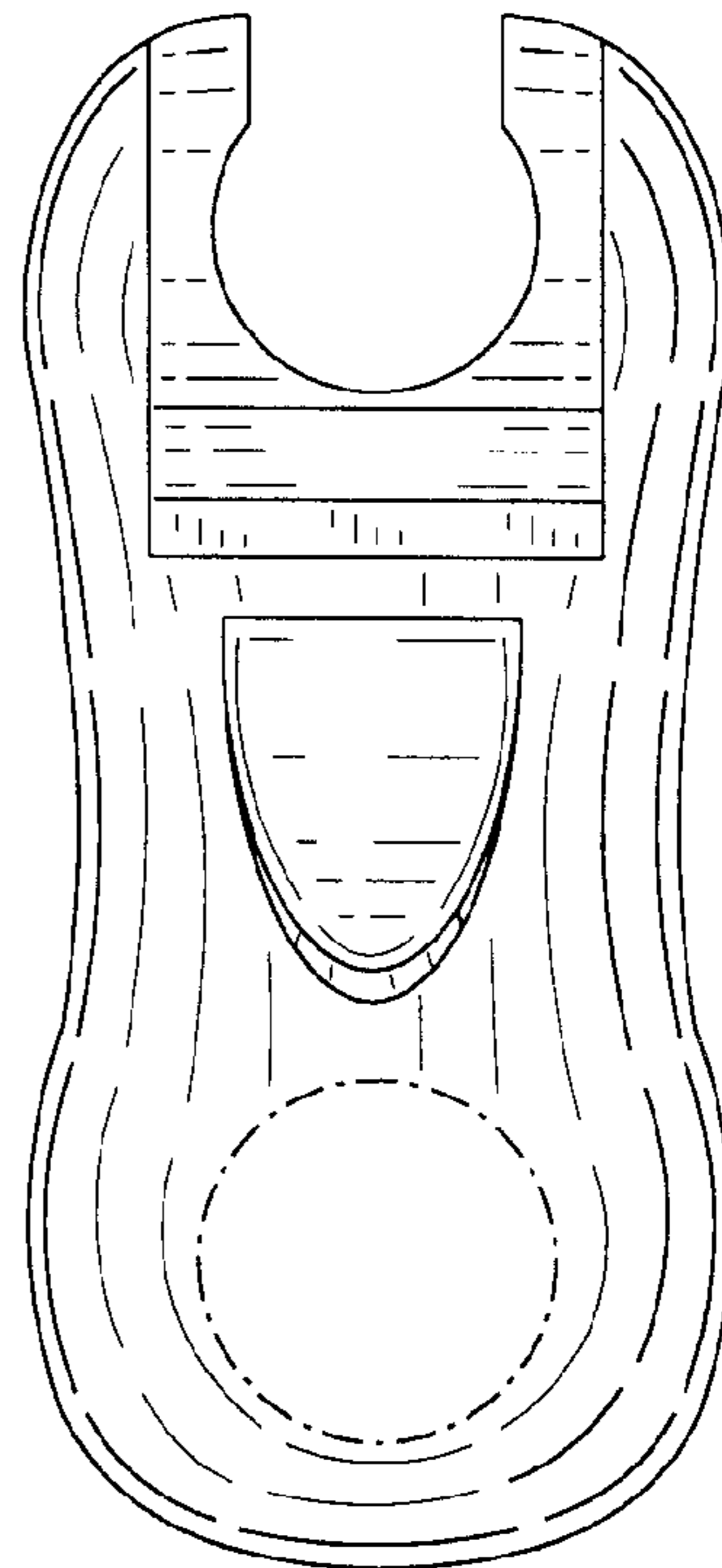

FIG. 7