



US00D519179S

(12) **United States Design Patent**  
**Roberts et al.**

(10) **Patent No.:** **US D519,179 S**  
(45) **Date of Patent:** **\*\* Apr. 18, 2006**

(54) **REAR CAVITY SURFACE DESIGN FOR PERIMETER WEIGHTED IRON-TYPE GOLF CLUB HEAD**

D428,633 S \* 7/2000 Hasebe' ..... D21/748  
D473,904 S \* 4/2003 Llewellyn et al. .... D21/759  
D486,543 S \* 2/2004 Gilbert et al. .... D21/759

(75) Inventors: **Douglas E. Roberts**, La Palma, CA (US); **Kevin A. Wolfe**, Huntington Beach, CA (US); **Trent E. Garner**, Cypress, CA (US)

\* cited by examiner

*Primary Examiner*—Mitchell Siegel  
(74) *Attorney, Agent, or Firm*—Steptoe & Johnson LLP

(73) Assignee: **Roger Cleveland Golf Company, Inc.**, Cypress, CA (US)

(57) **CLAIM**

The design of the rear cavity surface design for perimeter weighted iron-type golf club head, substantially as shown in the attached drawings.

(\*\*) Term: **14 Years**

**DESCRIPTION**

(21) Appl. No.: **29/205,882**

FIG. 1 is a perspective view of the rear cavity surface design for perimeter weighted iron-type golf club head;  
FIG. 2 is another perspective view thereof;  
FIG. 3 is another perspective view thereof;  
FIG. 4 is another perspective view thereof;  
FIG. 5 is another perspective view thereof; and,  
FIG. 6 is another perspective view thereof.  
The broken line showing is for illustrative purposes only and forms no part of the claimed design.

(22) Filed: **May 24, 2004**

(51) **LOC (8) Cl.** ..... **21-02**

(52) **U.S. Cl.** ..... **D21/759**

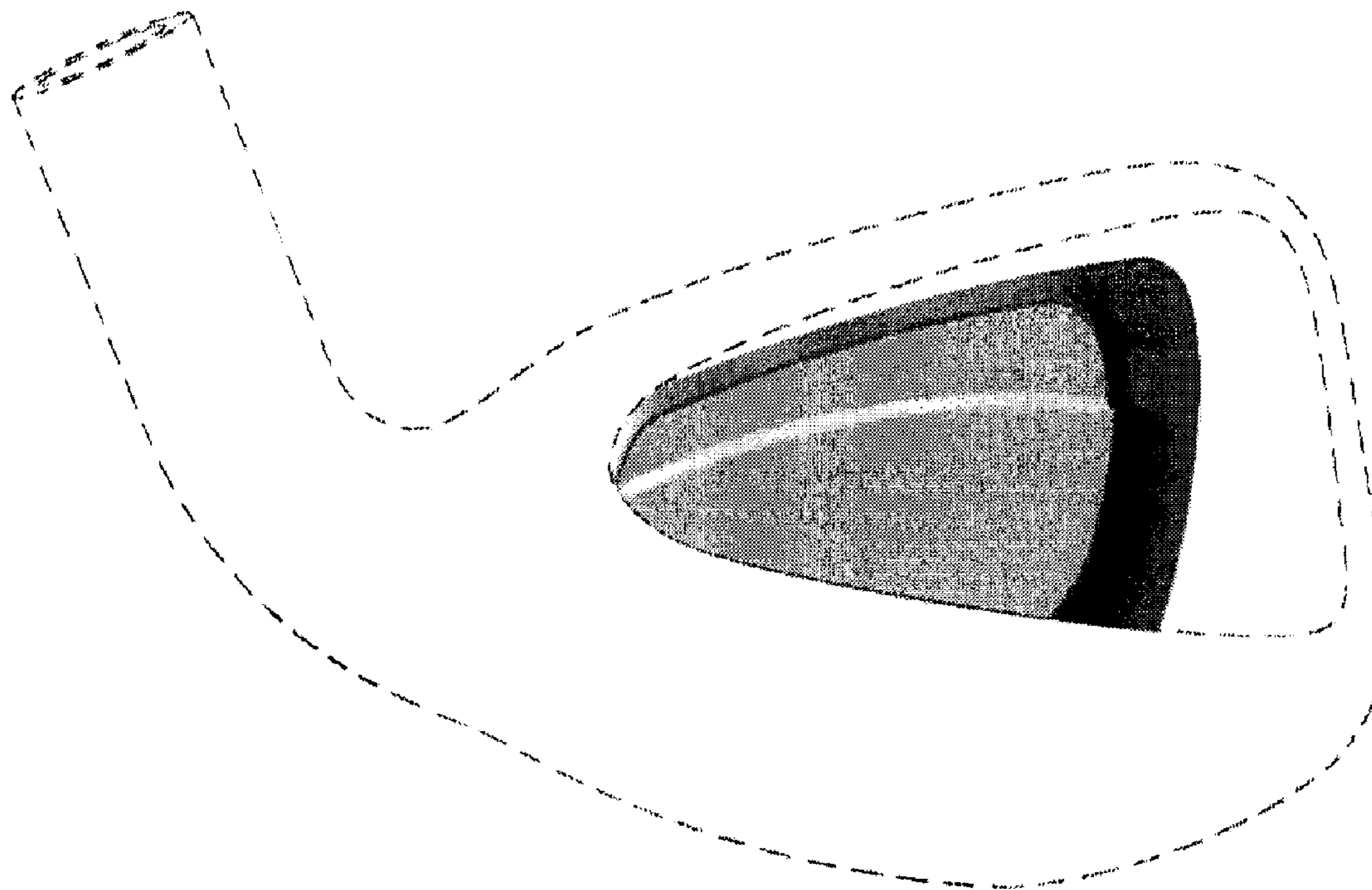
(58) **Field of Classification Search** ..... D21/747-751,  
D21/759; 473/324-331, 350  
See application file for complete search history.

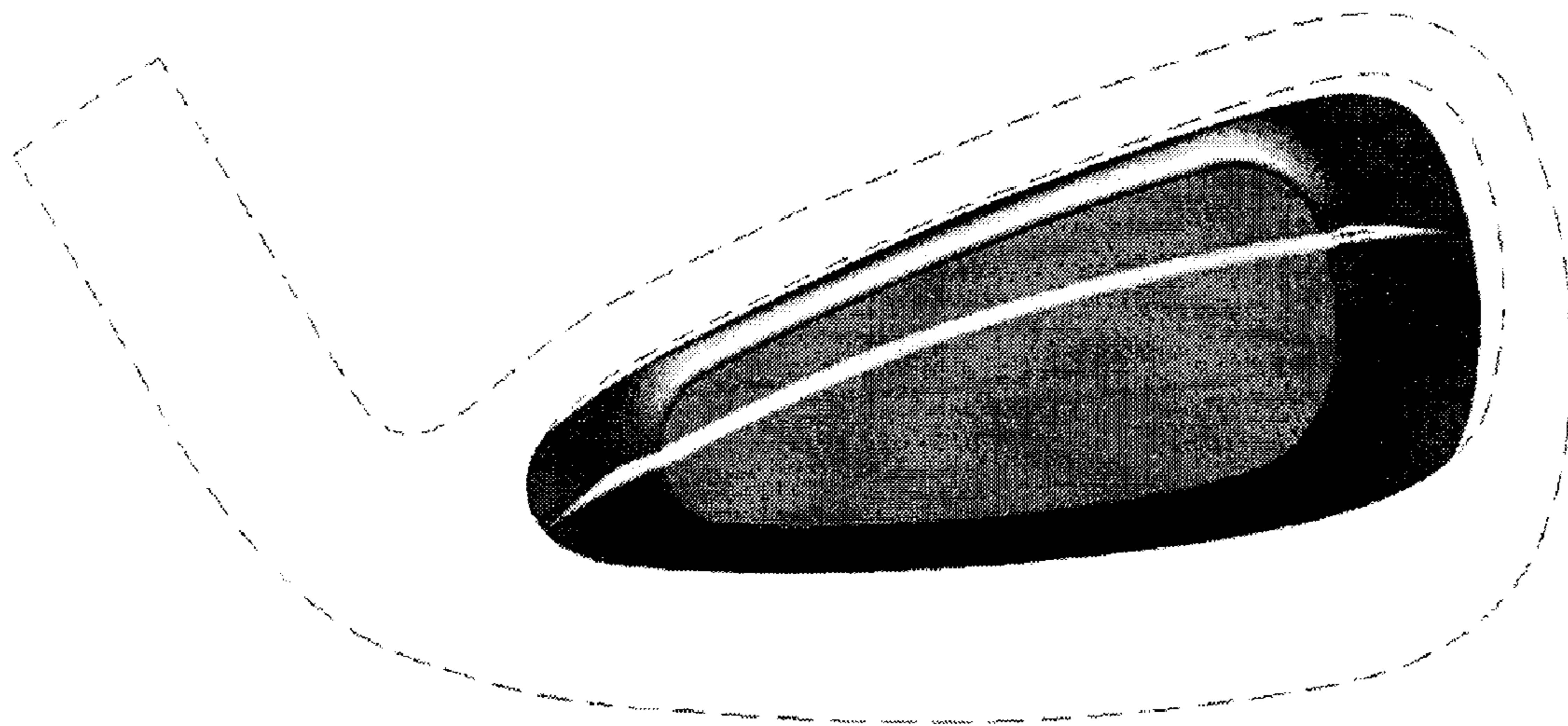
(56) **References Cited**

**U.S. PATENT DOCUMENTS**

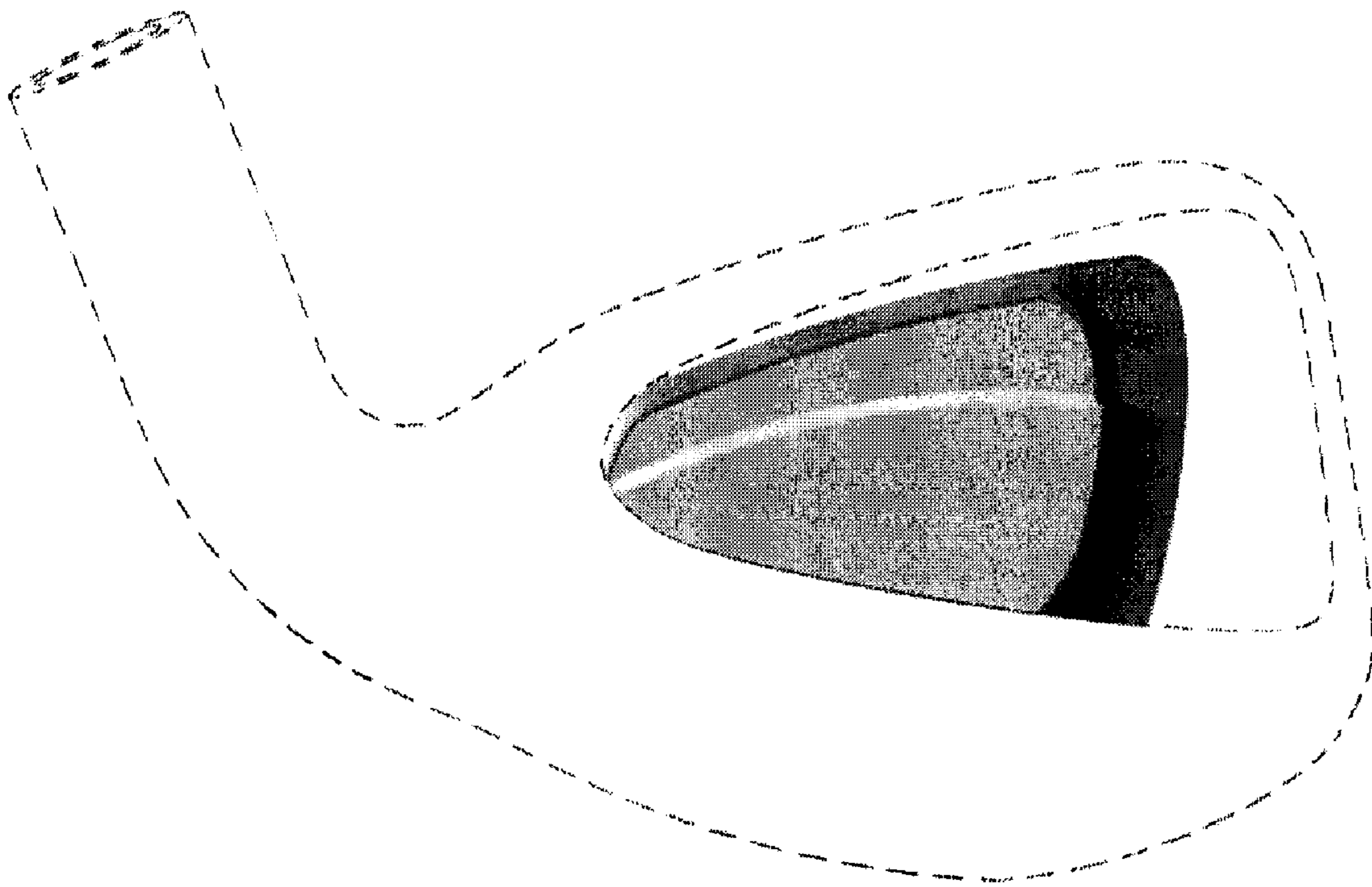
D417,248 S \* 11/1999 Matsuo ..... D21/748

**1 Claim, 6 Drawing Sheets**

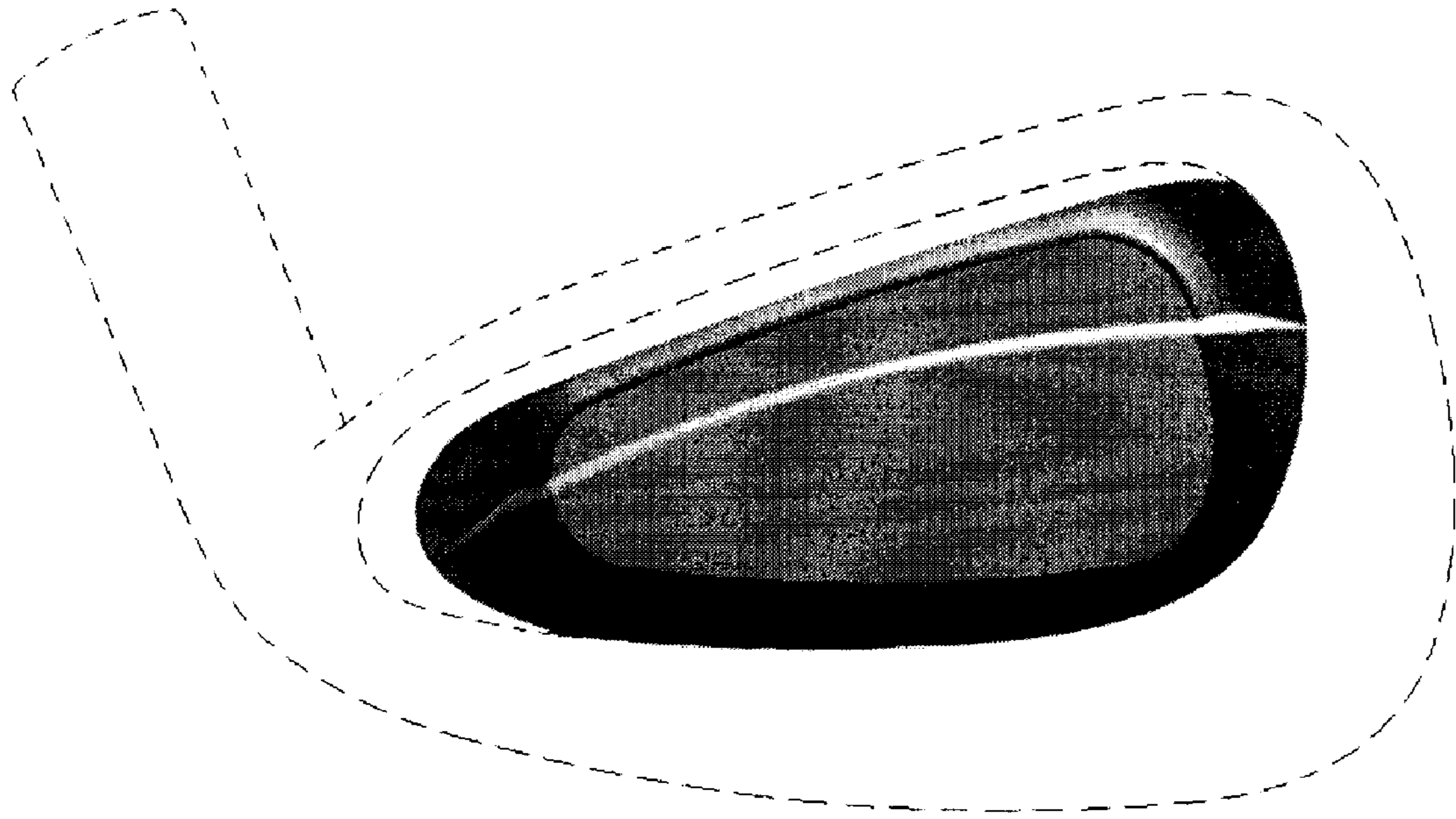




**Fig. 1**

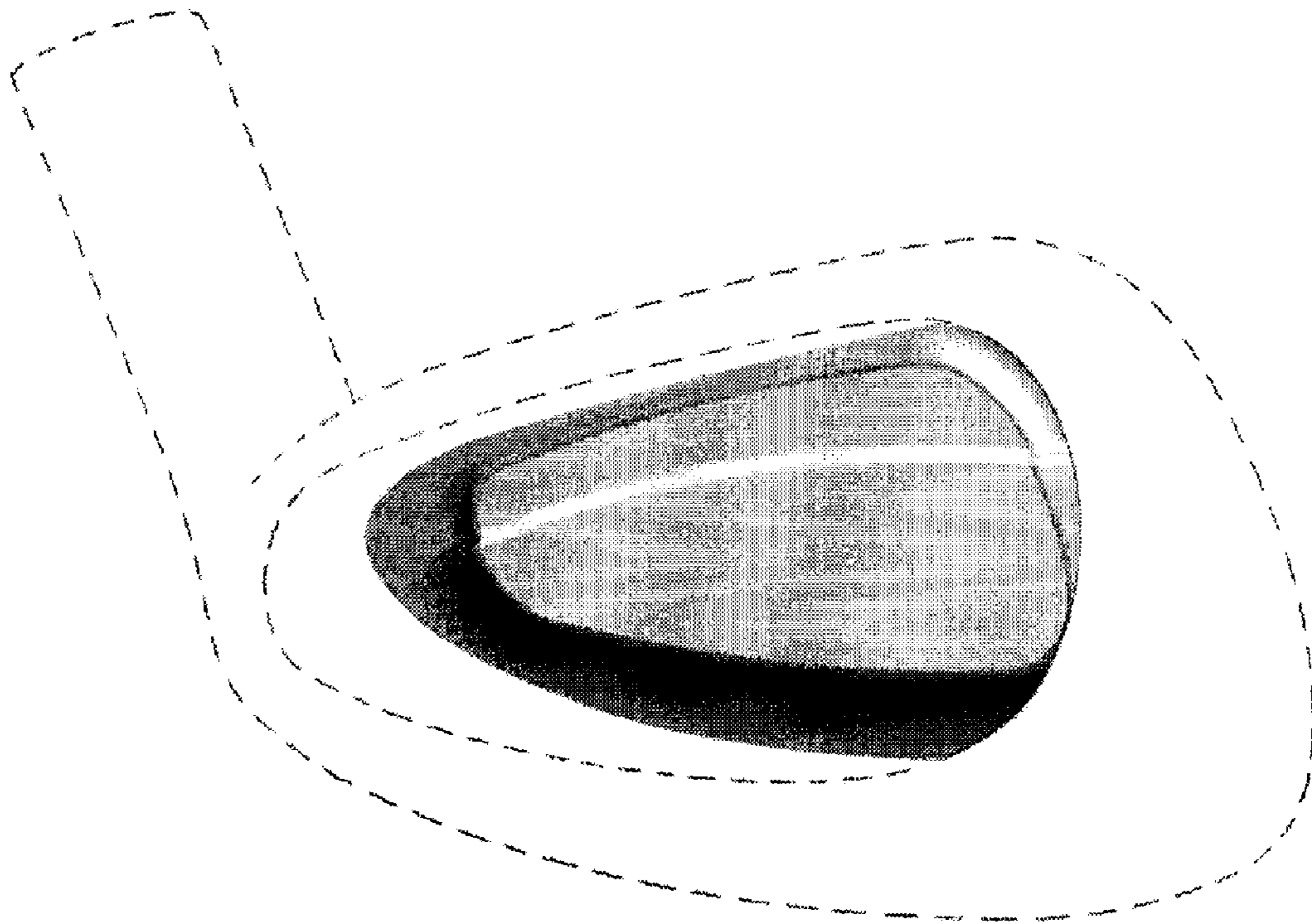


**Fig. 2**

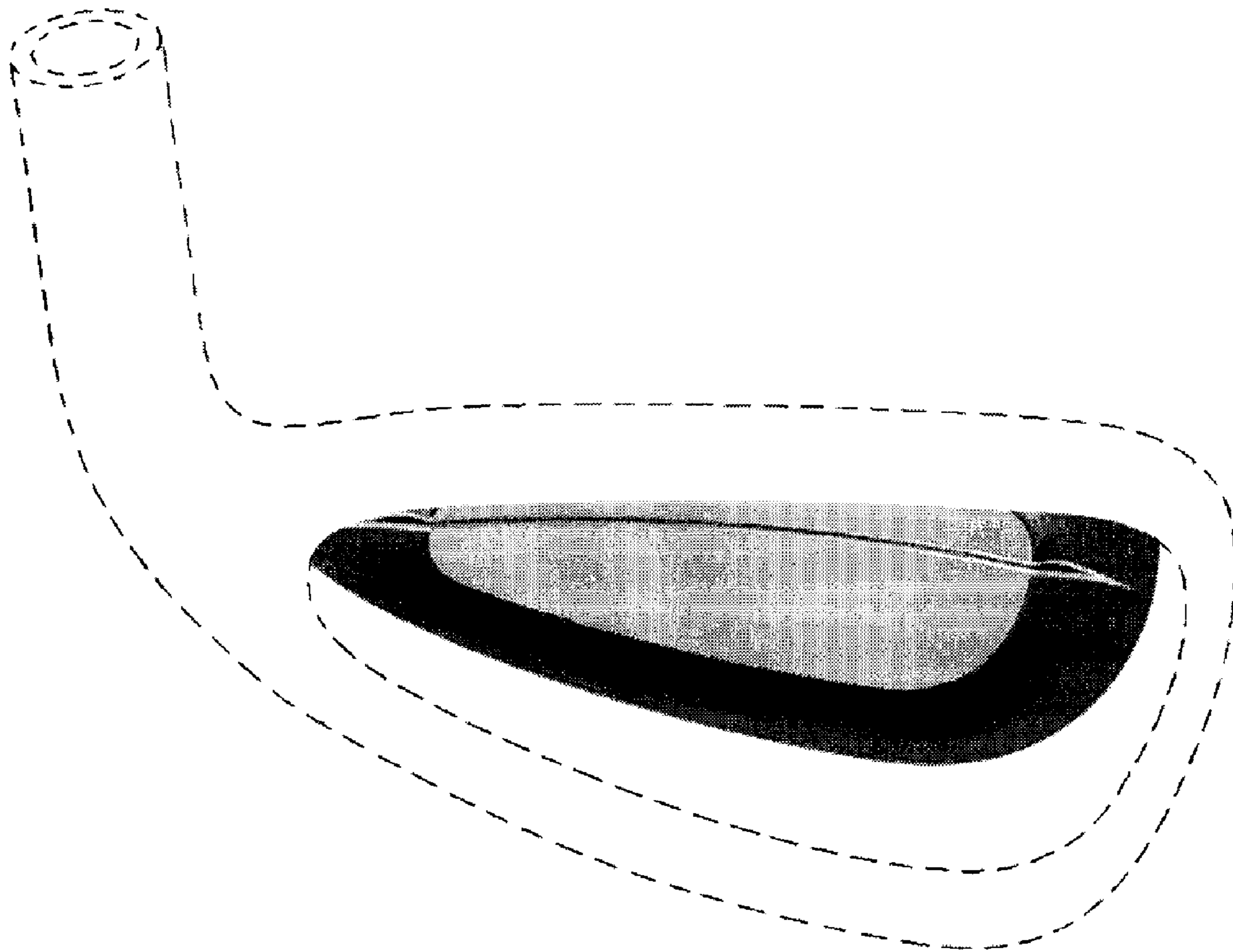


**Fig. 3**

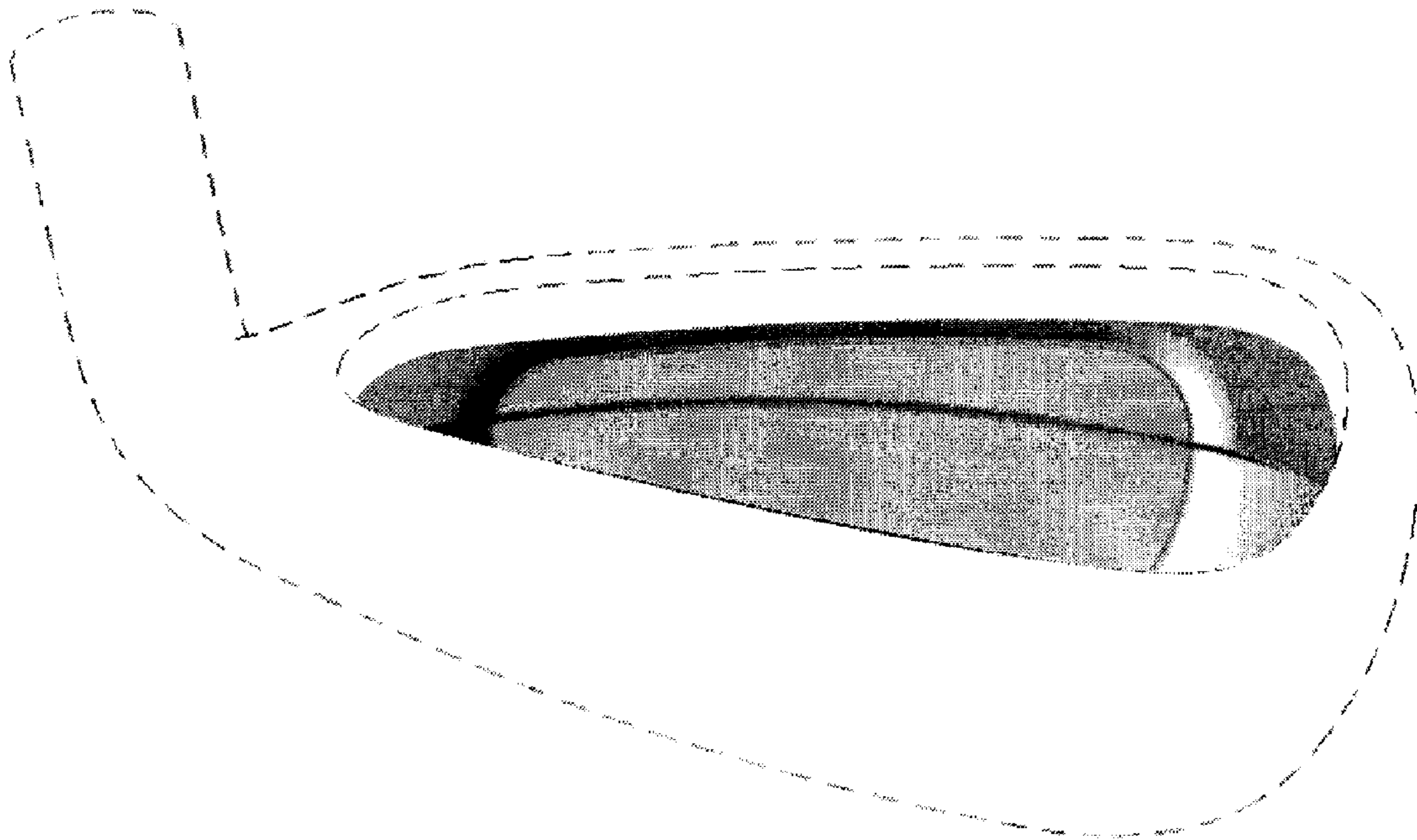




**Fig. 4**



**Fig. 5**



**Fig. 6**