



US00D519112S

(12) **United States Design Patent**  
**Yang**

(10) **Patent No.:** **US D519,112 S**

(45) **Date of Patent:** **\*\* Apr. 18, 2006**

(54) **MICROPHONE HEAD SHELL**

(76) **Inventor:** **Chih-Feng Yang**, 14F-2, No. 185, Sec. 2, Kung Yi Rd., Taichung (TW)

(\*\*) **Term:** **14 Years**

(21) **Appl. No.:** **29/217,408**

(22) **Filed:** **Aug. 3, 2004**

(51) **LOC (8) Cl.** ..... **14-01**

(52) **U.S. Cl.** ..... **D14/228**

(58) **Field of Classification Search** ..... D14/224, D14/225, 226, 227, 228, 229; D21/513, 708, D21/709; 181/158, 242; 381/157, 158, 181, 381/355-360, 361, 369; 446/416; 473/379, 473/380, 383

See application file for complete search history.

(56) **References Cited**

**U.S. PATENT DOCUMENTS**

- D230,990 S \* 3/1974 Kollesberger ..... D14/228
- D310,368 S \* 9/1990 Derhaag et al. .... D14/228
- D319,483 S \* 8/1991 Machin et al. .... D21/709
- D449,041 S \* 10/2001 Koike ..... D14/228

- D462,343 S \* 9/2002 Wang et al. .... D14/228
- D479,836 S \* 9/2003 Thornton et al. .... D14/228
- D487,739 S \* 3/2004 Wise ..... D14/225

\* cited by examiner

*Primary Examiner*—Paula A. Greene

(57) **CLAIM**

The ornamental design for a microphone head shell, as shown and described.

**DESCRIPTION**

FIG. 1 is a perspective view of the microphone head shell showing my new design;  
 FIG. 2 is a front view thereof;  
 FIG. 3 is a rear view thereof;  
 FIG. 4 is a left side view thereof;  
 FIG. 5 is a right side view thereof;  
 FIG. 6 is a top view thereof;  
 FIG. 7 is a bottom view thereof; and,  
 FIG. 8 is a front perspective view thereof, the broken lines are for illustrative purposes only and form no part of the claimed design.

**1 Claim, 5 Drawing Sheets**

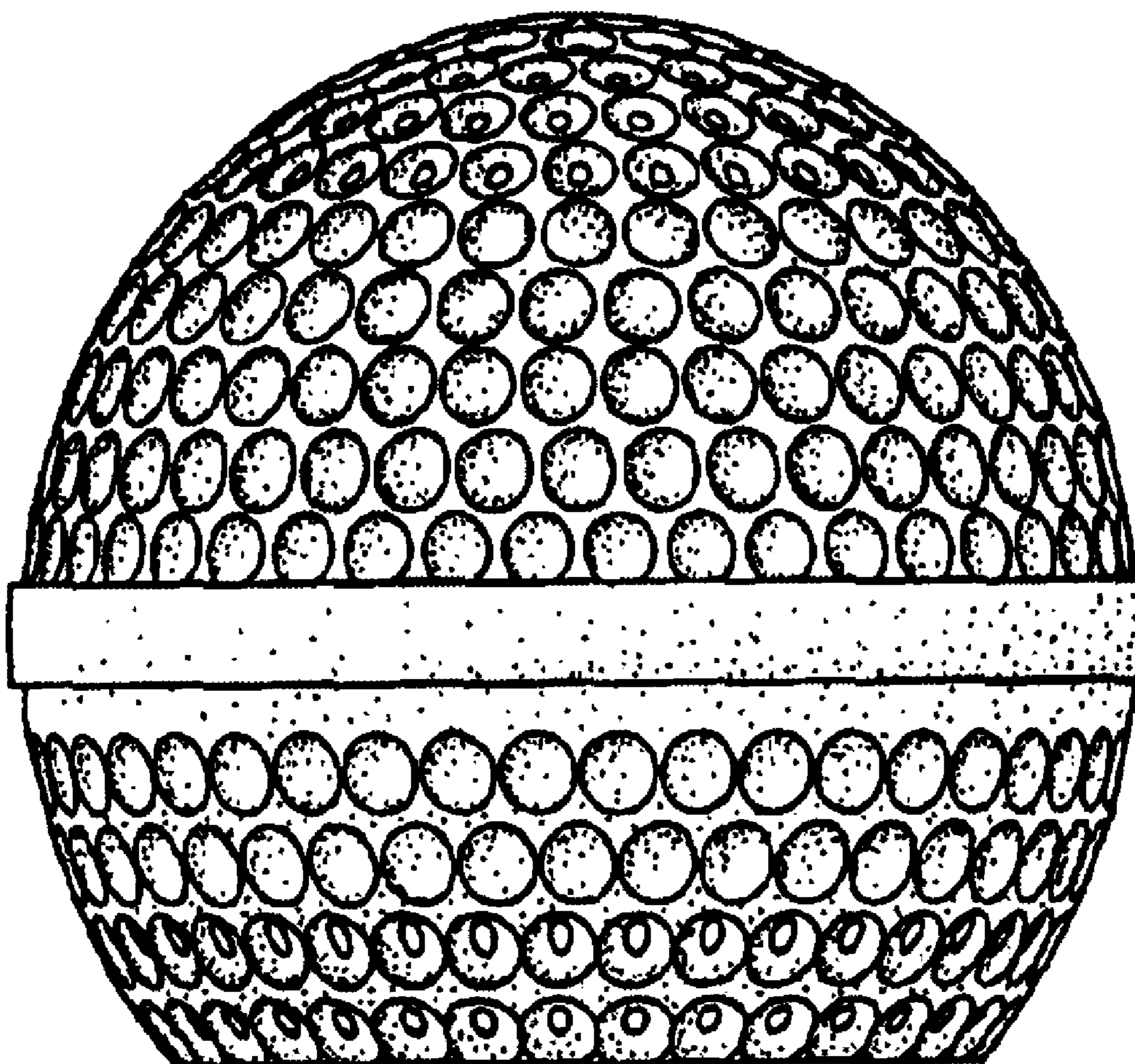

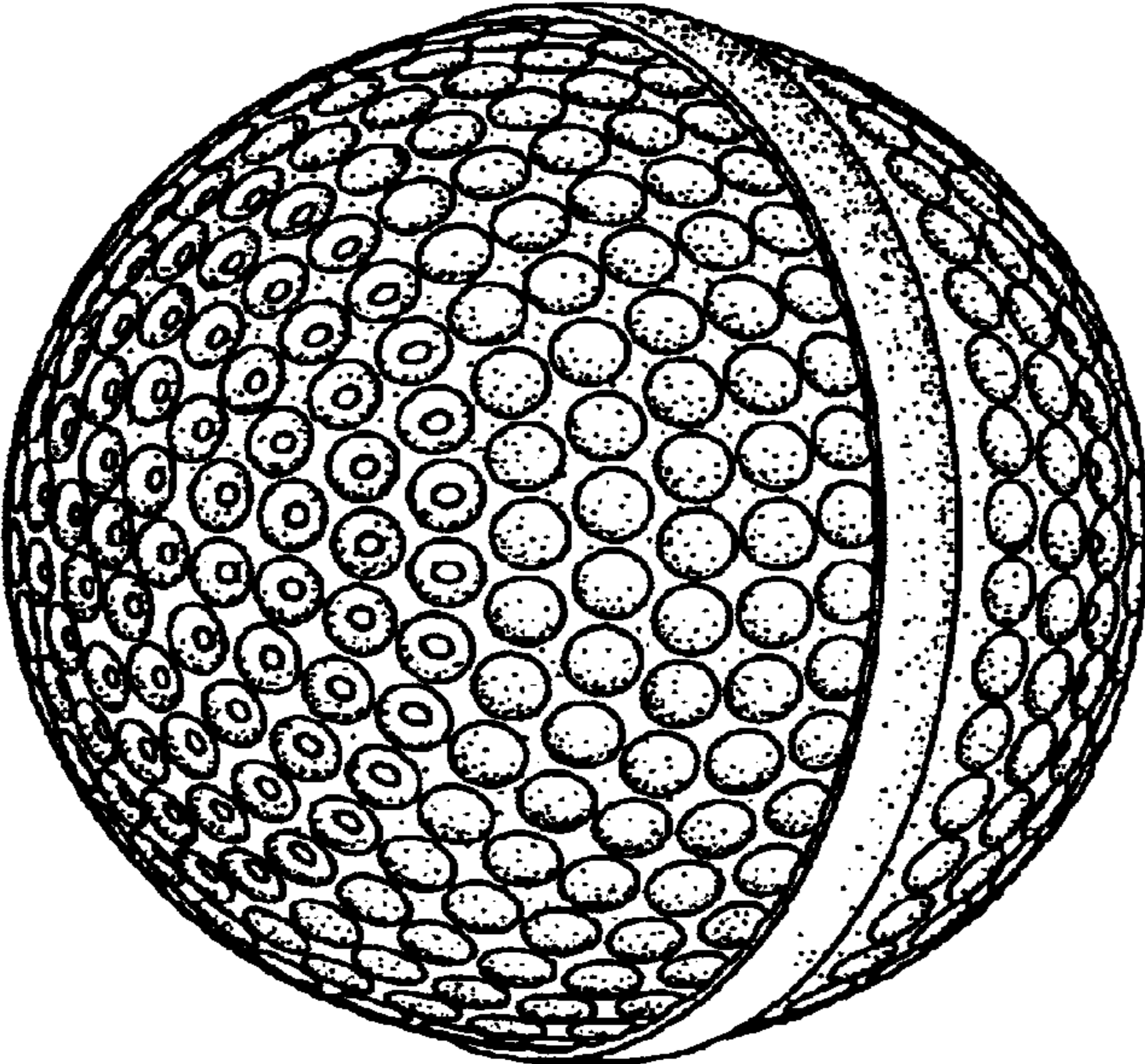

FIG.1

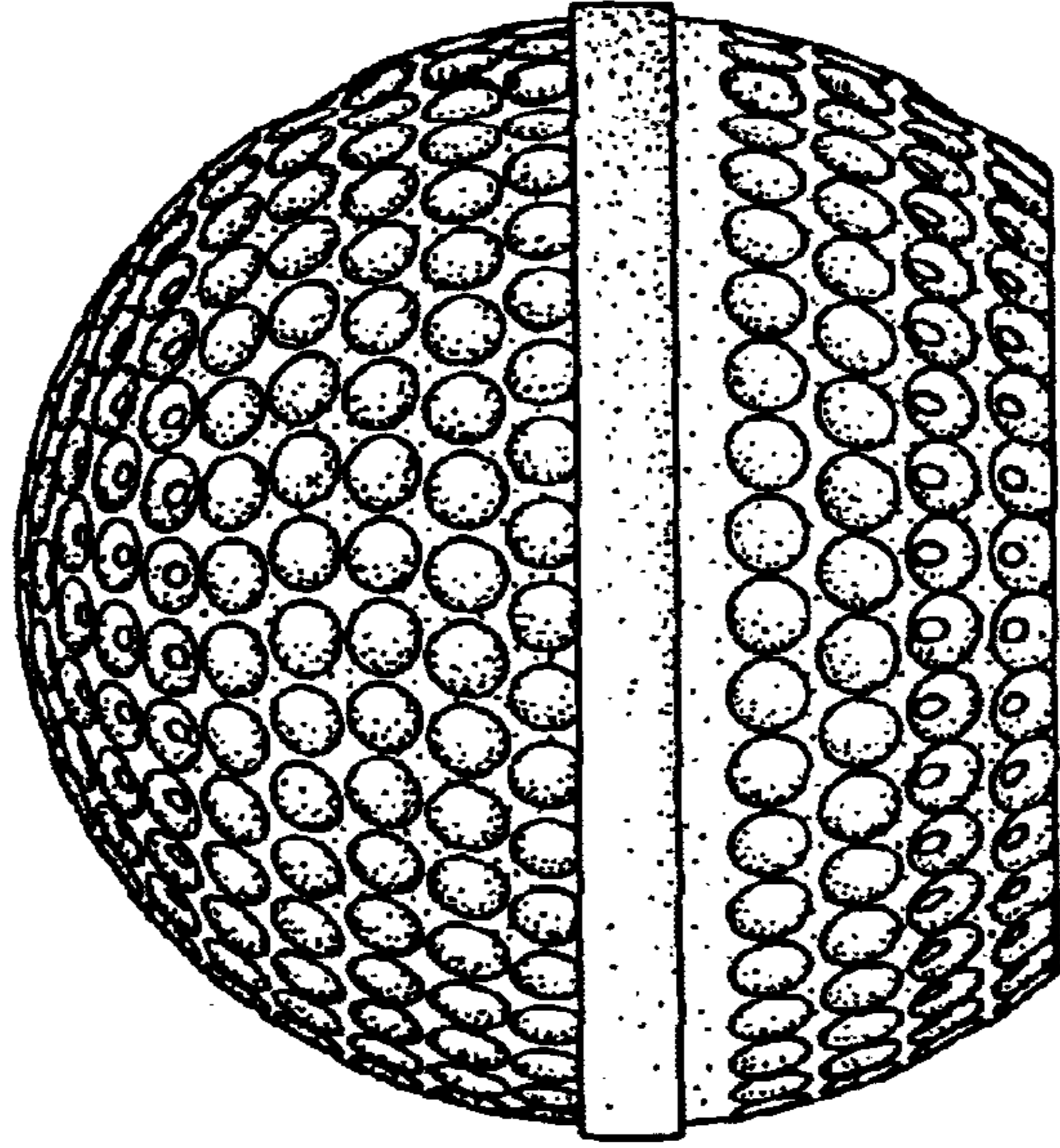

FIG.3

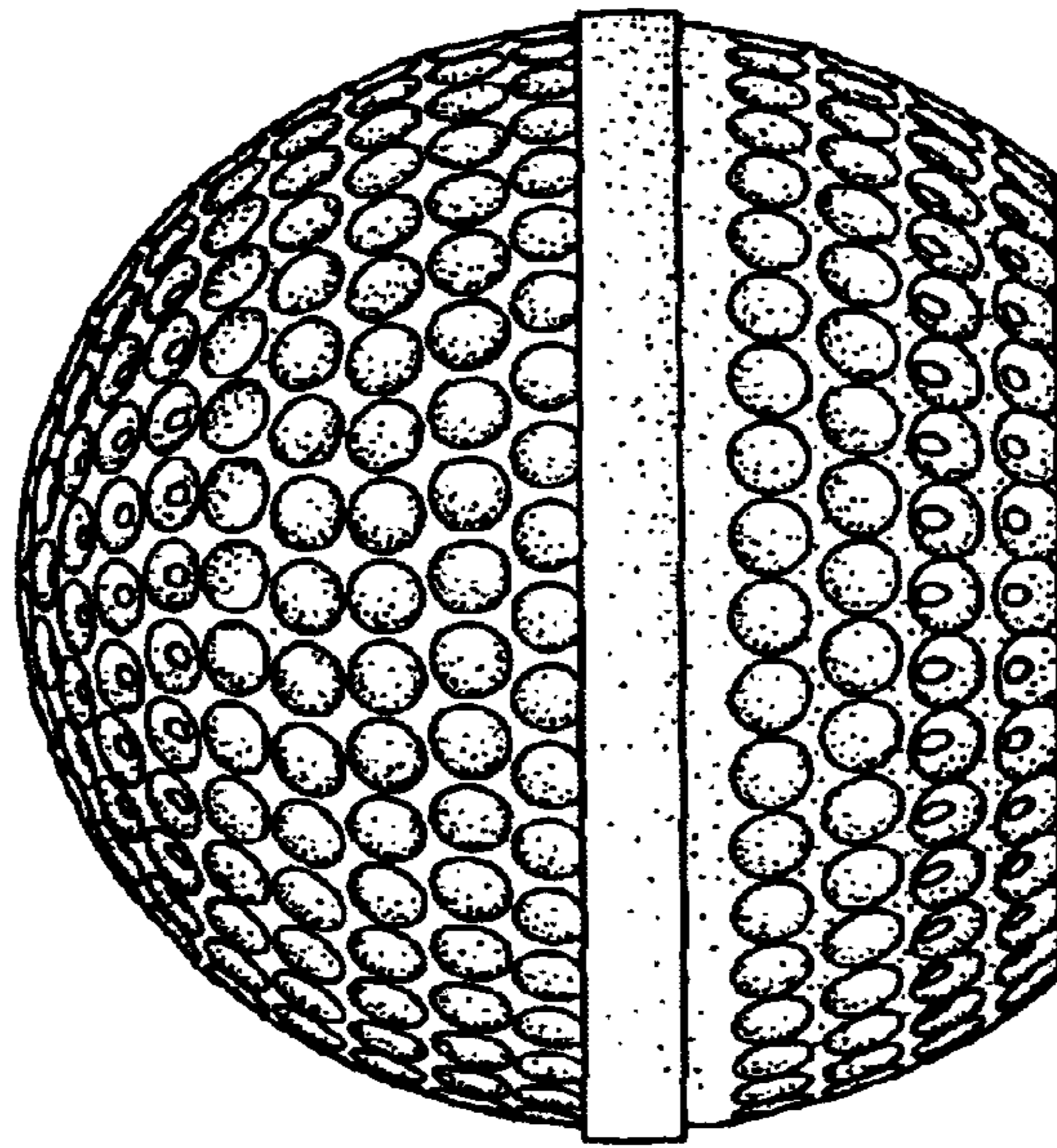

FIG.2

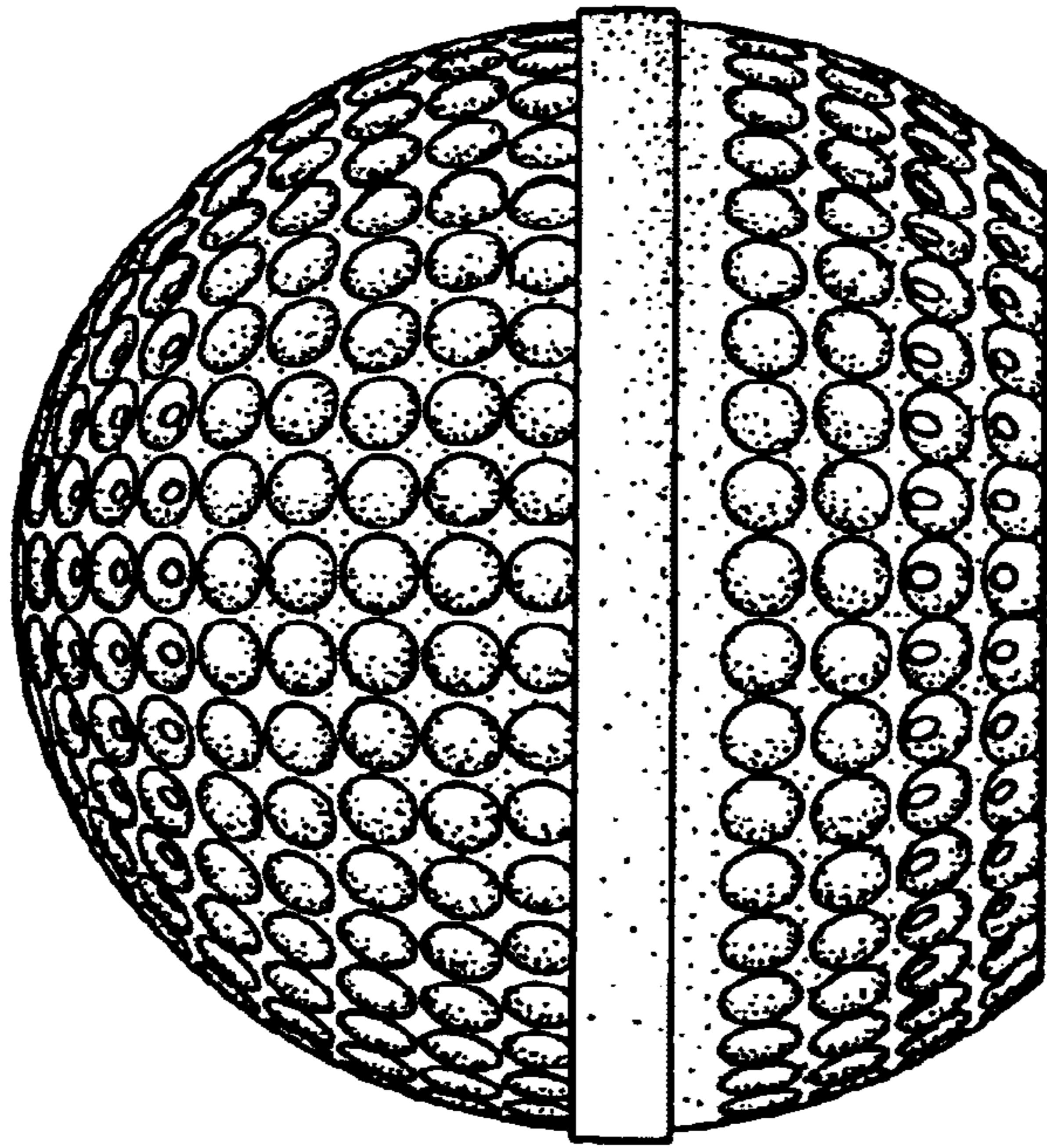

FIG. 5

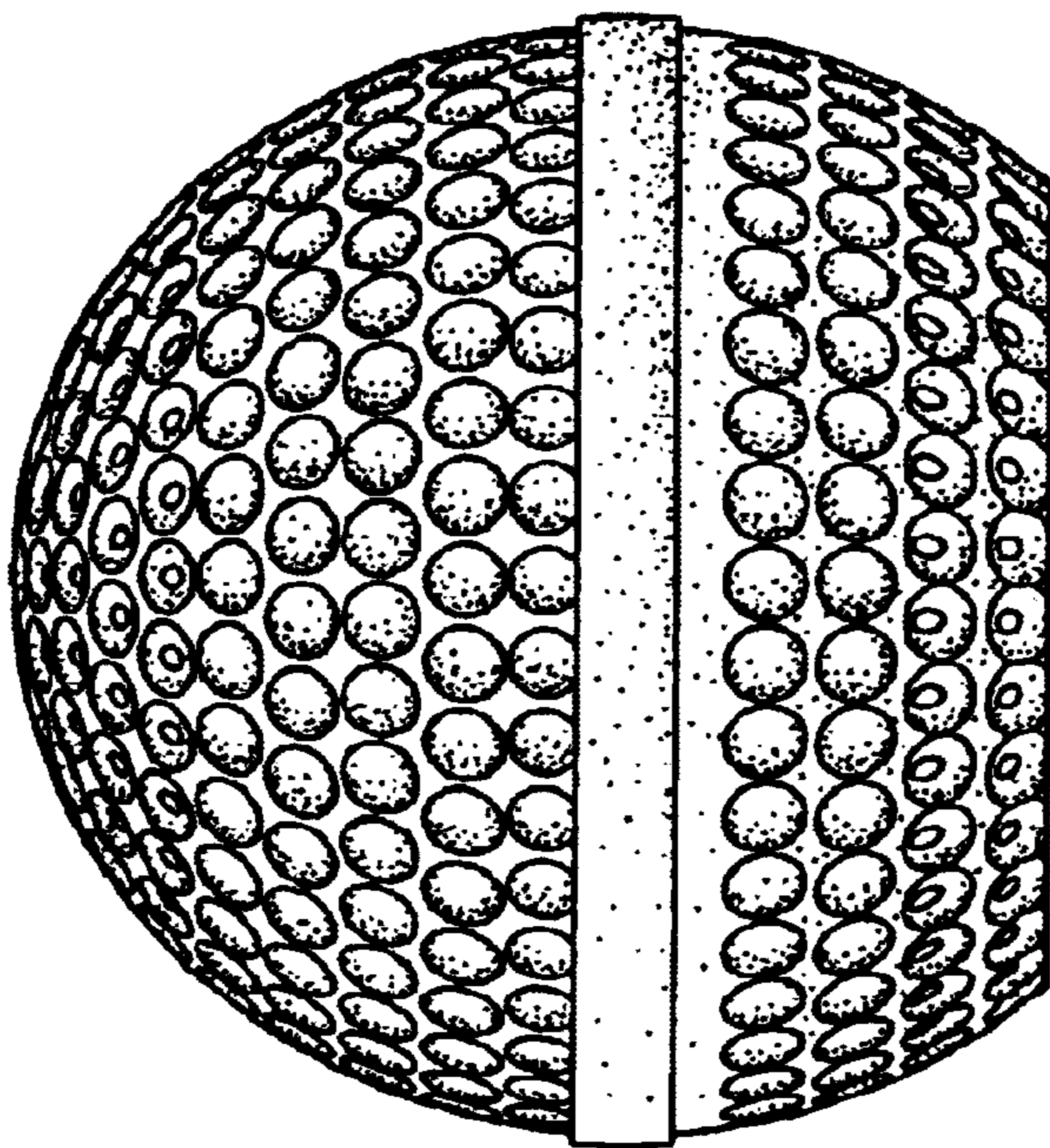

FIG. 4

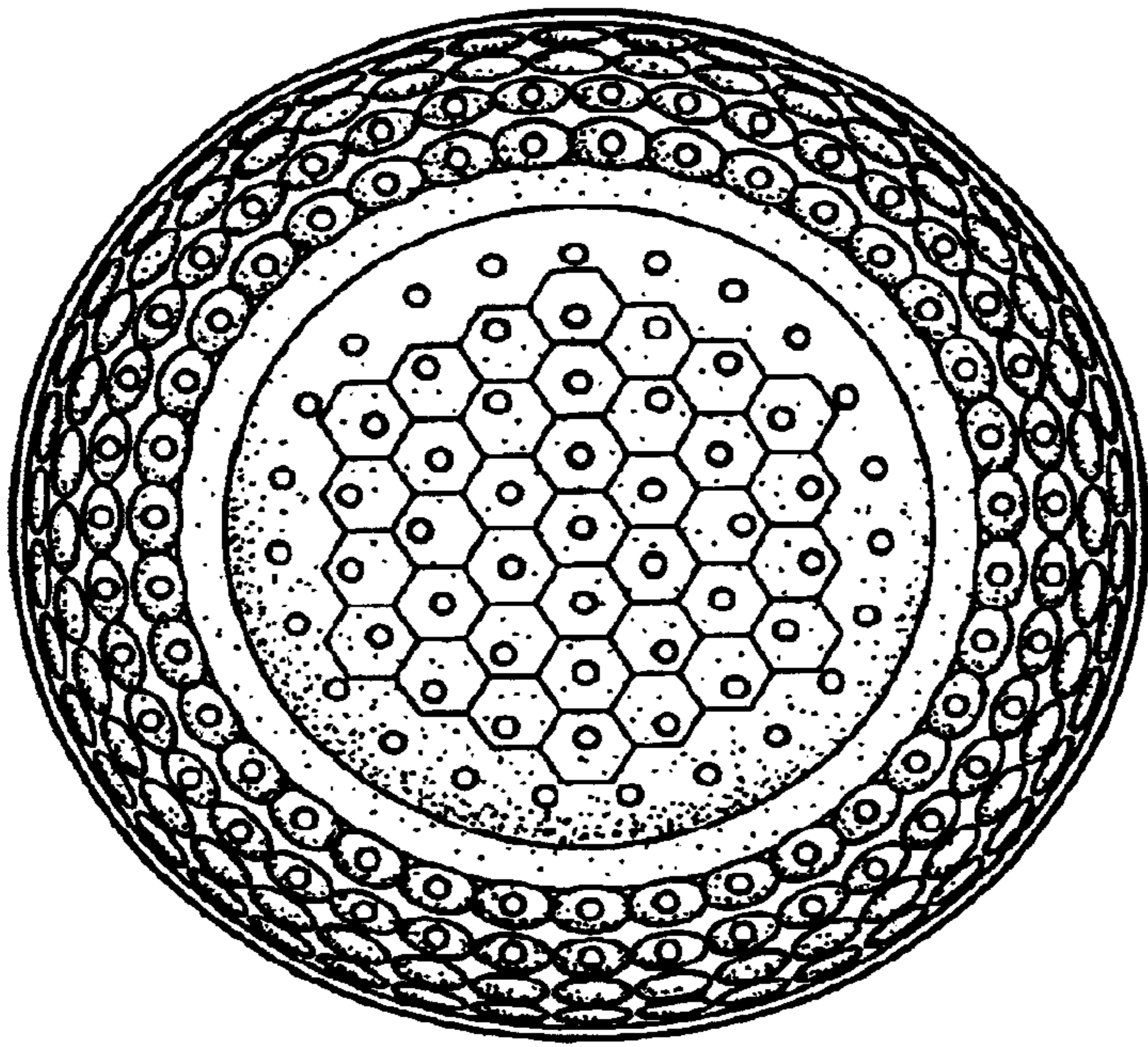

FIG. 7

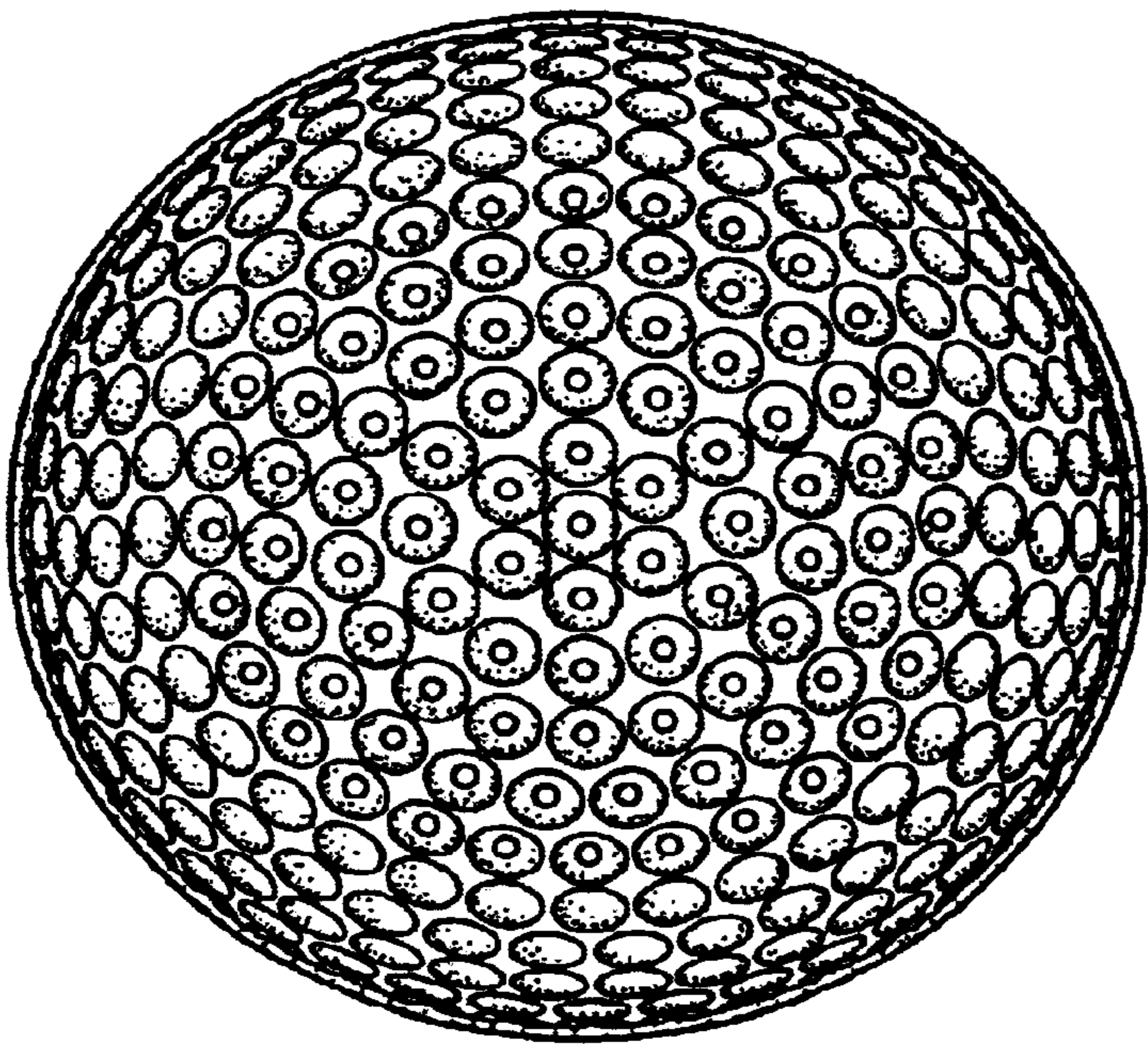

FIG. 6

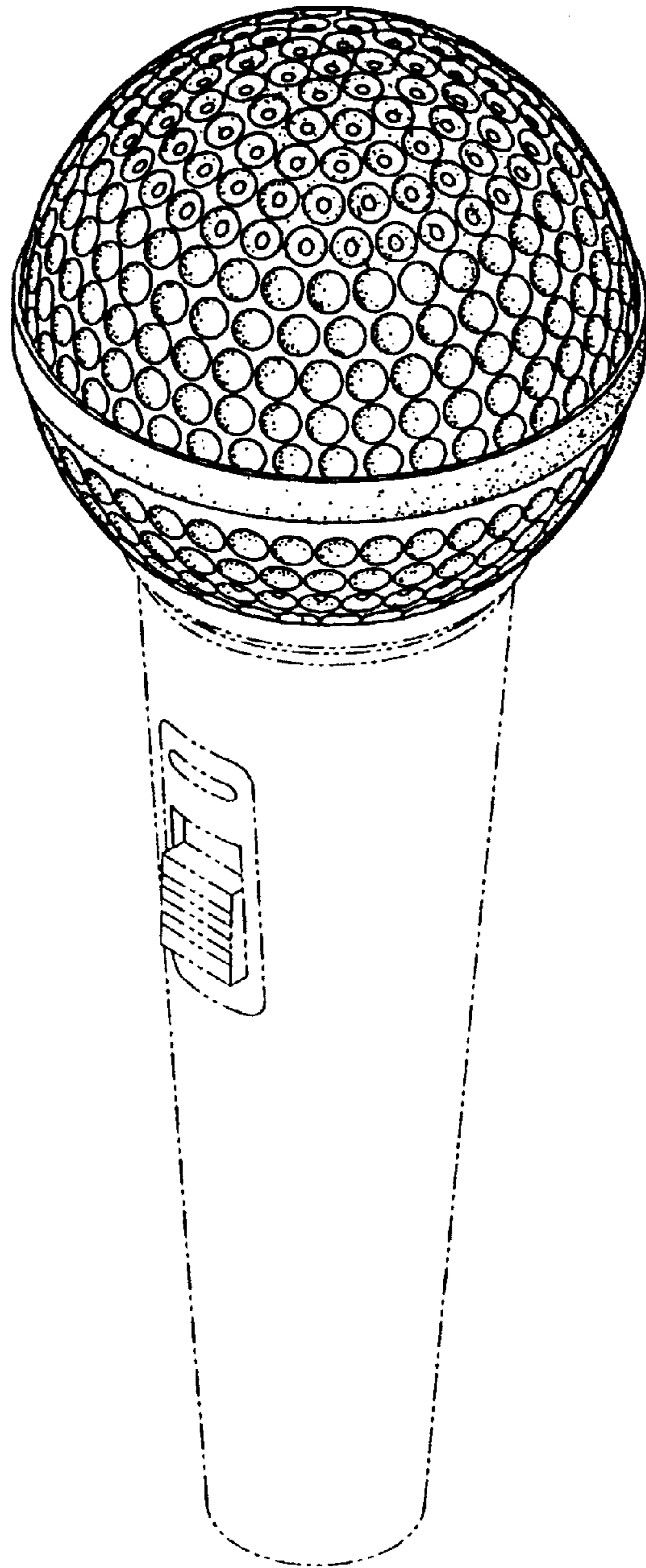

FIG.8