



US00D519035S

(12) **United States Design Patent**  
**Kelleghan**

(10) **Patent No.:** **US D519,035 S**

(45) **Date of Patent:** **\*\* Apr. 18, 2006**

(54) **EASTER ISLAND BOTTLE**

D196,326 S \* 9/1963 Linderman ..... D11/160  
D442,642 S \* 5/2001 Gaylord et al. .... D21/389  
D468,967 S \* 1/2003 Lipson ..... D7/515

(75) Inventor: **Brian James Kelleghan**, Longmont,  
CO (US)

\* cited by examiner

(73) Assignee: **Bison Designs, LLC**, Longmont, CO  
(US)

*Primary Examiner*—Sandra L. Morris  
(74) *Attorney, Agent, or Firm*—Margaret Polson Patent  
Law Offices of Rick Martin, PC

(\*\*) Term: **14 Years**

(57) **CLAIM**

(21) Appl. No.: **29/200,637**

The ornamental design for an Easter Island bottle, as shown  
and described.

(22) Filed: **Mar. 2, 2004**

(51) **LOC (8) Cl.** ..... **09-01**

**DESCRIPTION**

(52) **U.S. Cl.** ..... **D9/616; D9/625; D9/620;**  
D7/517

FIG. 1 is a front side elevation view of my new design for  
an easter island bottle with a lid attached, the lid is shown  
in dotted lines which is for illustrative purposes only and is  
not part of the claimed design.

(58) **Field of Classification Search** ..... D7/514–518,  
D7/571, 619.2, 628; D9/600, 614, 616, 620,  
D9/625, 626, 628; D11/157–158, 160; D21/623,  
D21/630, 639, 659–660; 206/457; 215/379–385,  
215/400

FIG. 2 is a rear side elevation view of FIG. 1.

FIG. 3 is a is front perspective view of FIG. 1.

FIG. 4 is a top plan view of FIG. 1.

FIG. 5 is a bottom plan view of FIG. 1.

FIG. 6 is a right side elevation view of FIG. 1; and,

FIG. 7 is a left side elevation view of FIG. 1.

See application file for complete search history.

(56) **References Cited**

**U.S. PATENT DOCUMENTS**

D188,353 S \* 7/1960 Merrill ..... D9/620

**1 Claim, 2 Drawing Sheets**

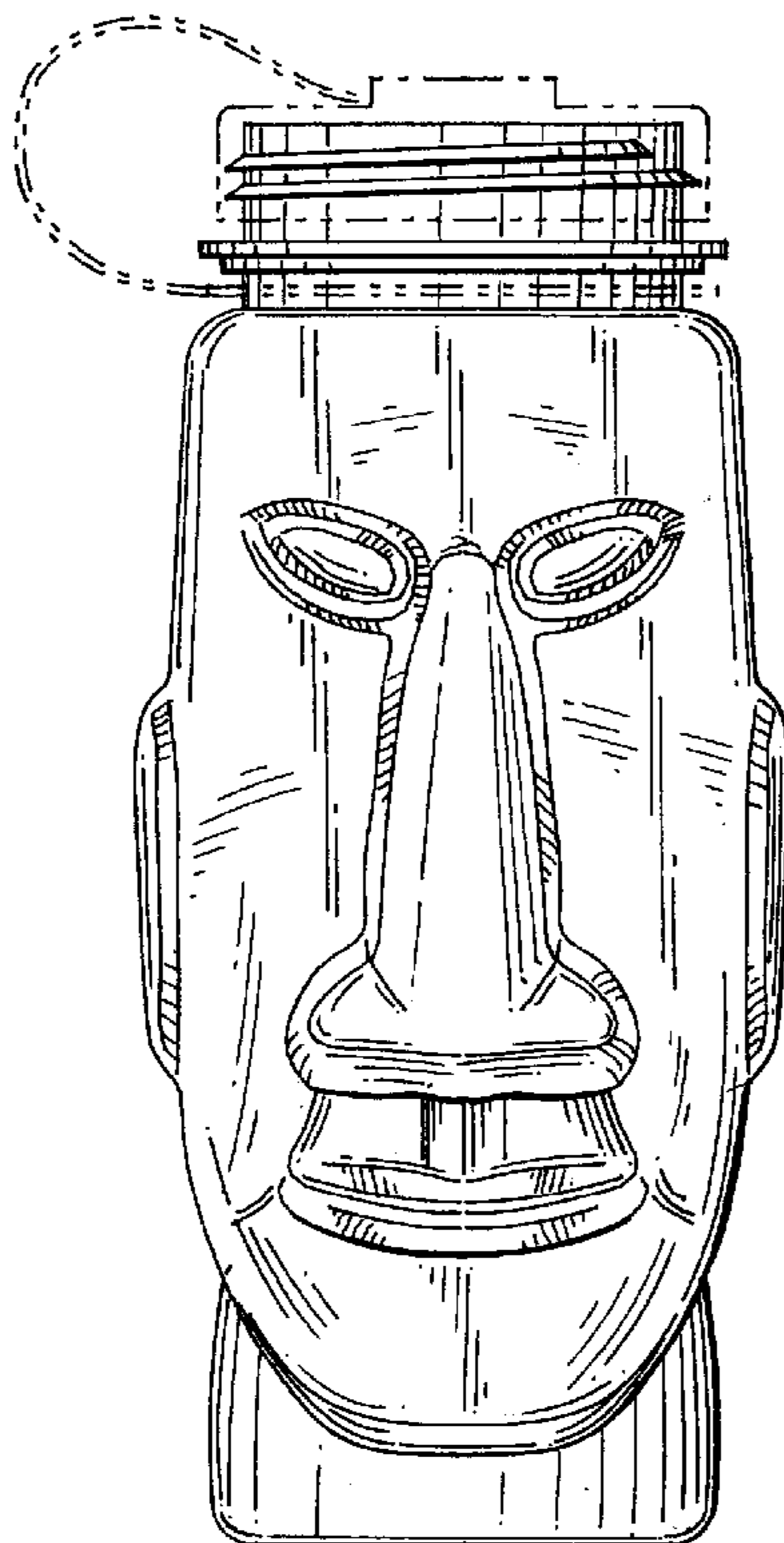

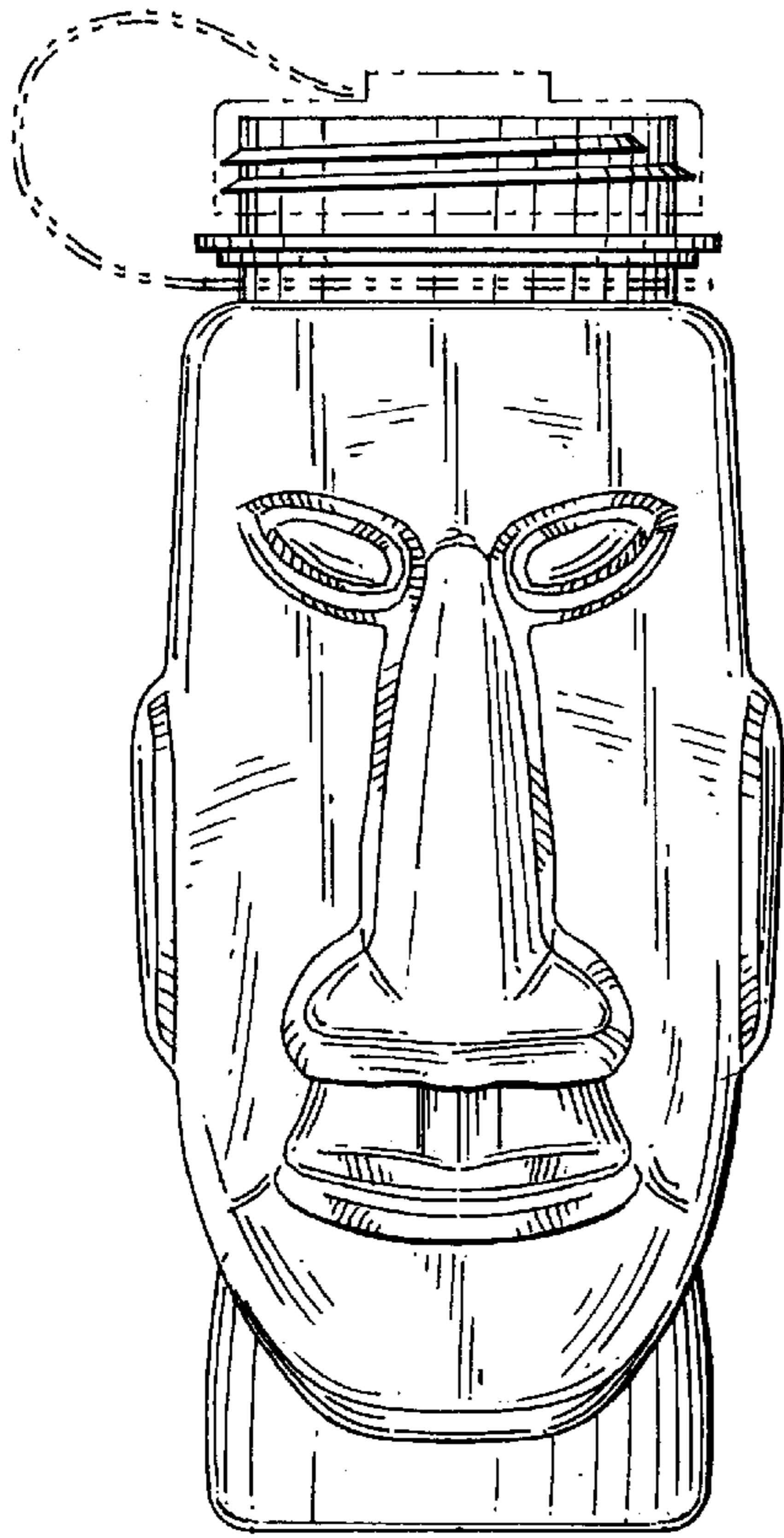

FIG. 1

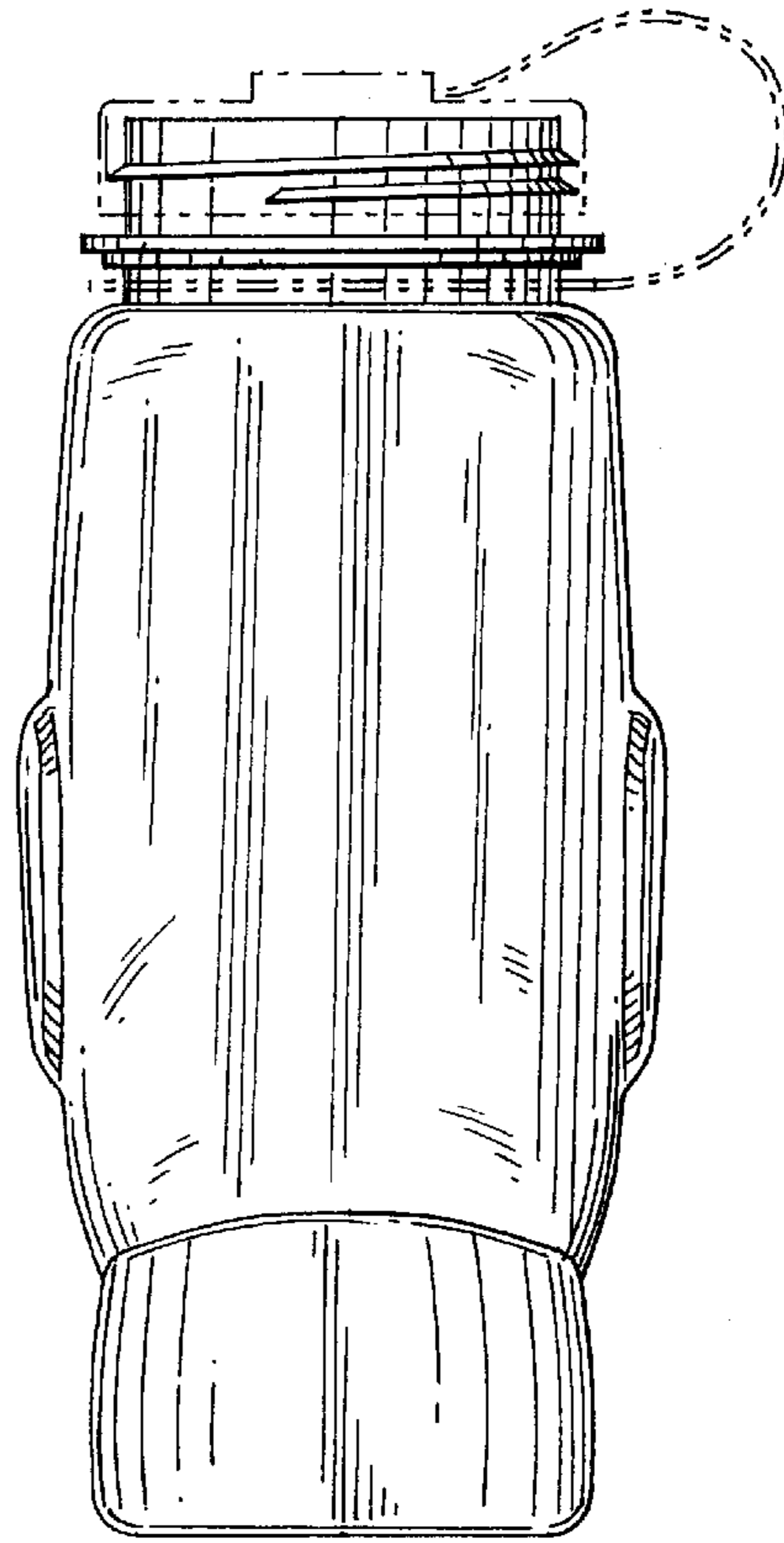

FIG. 2

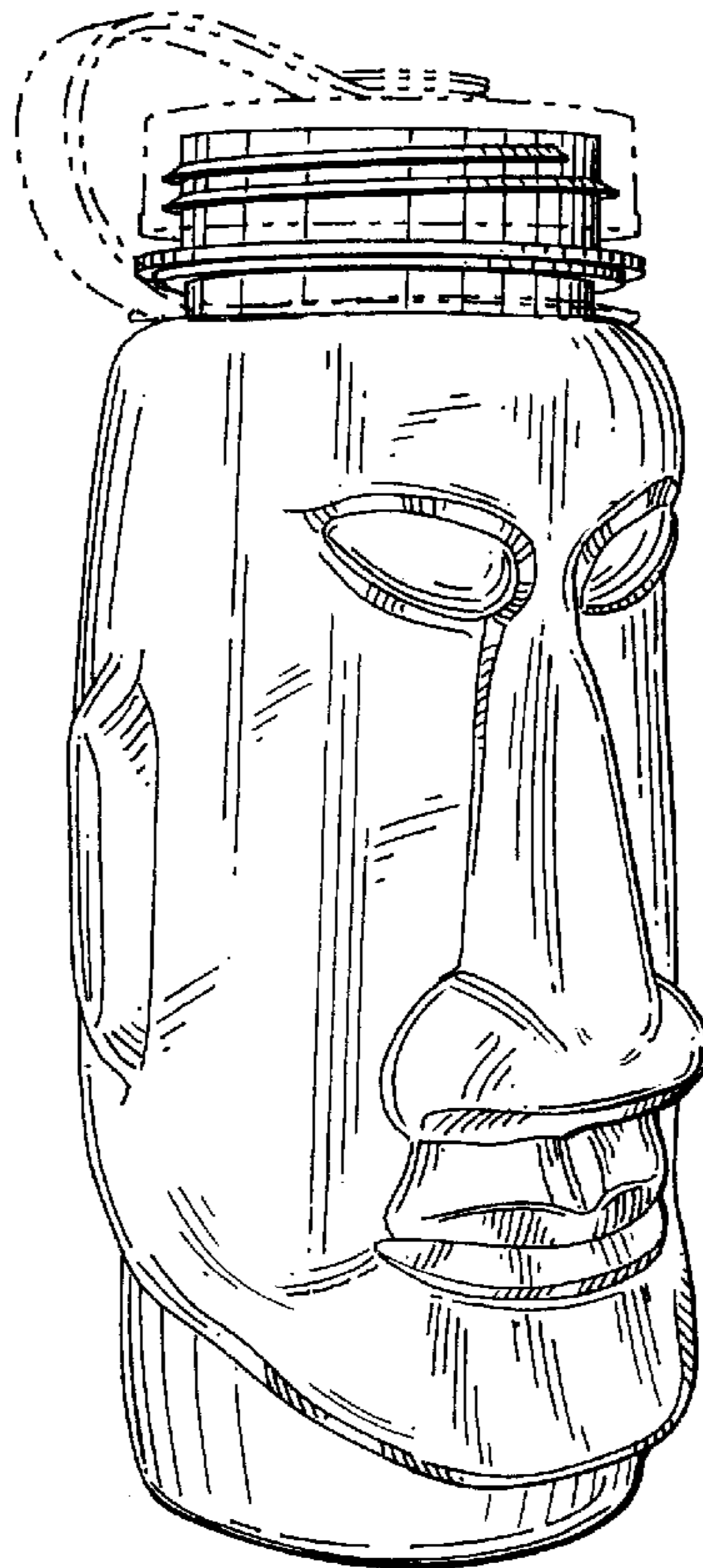
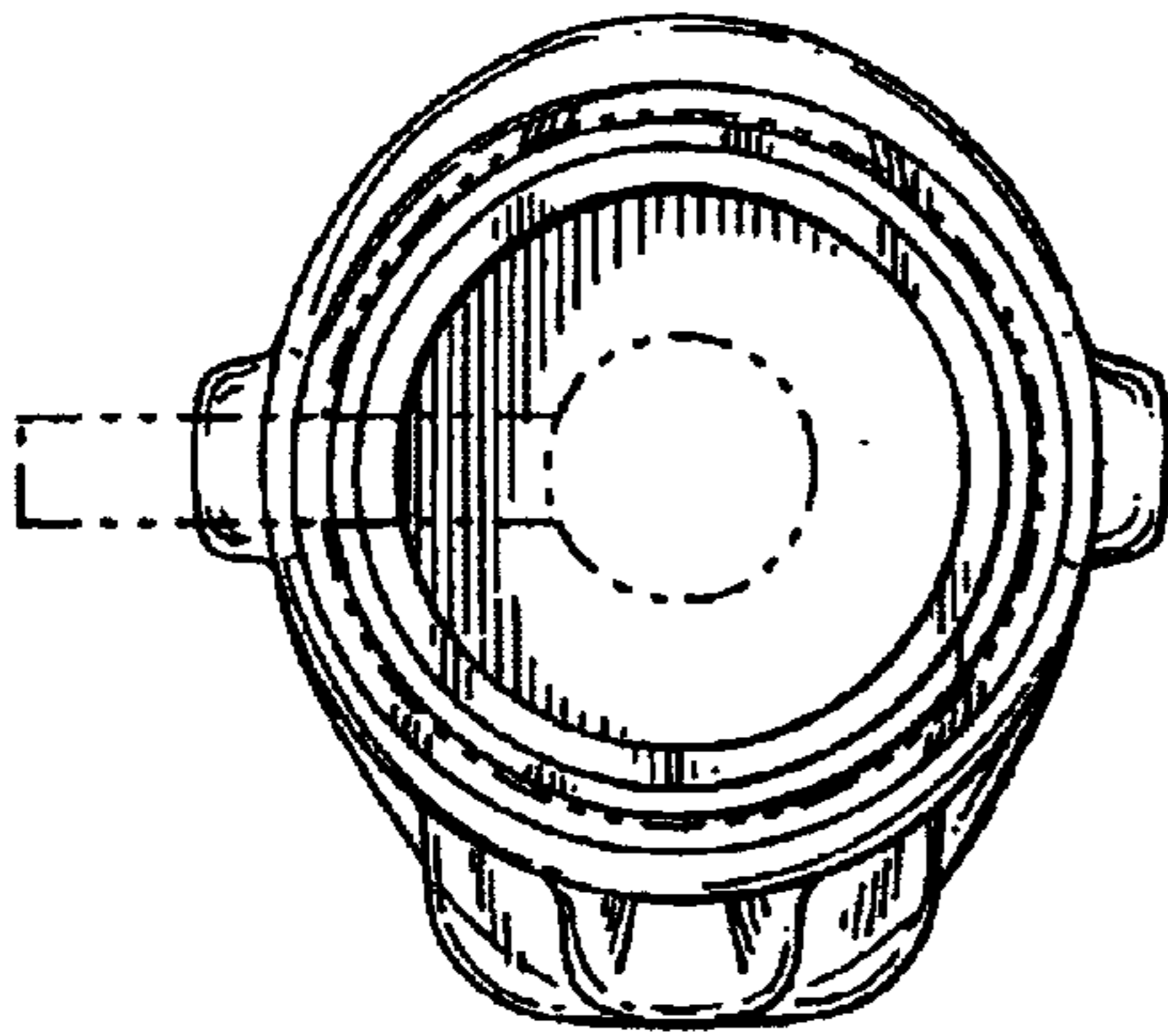
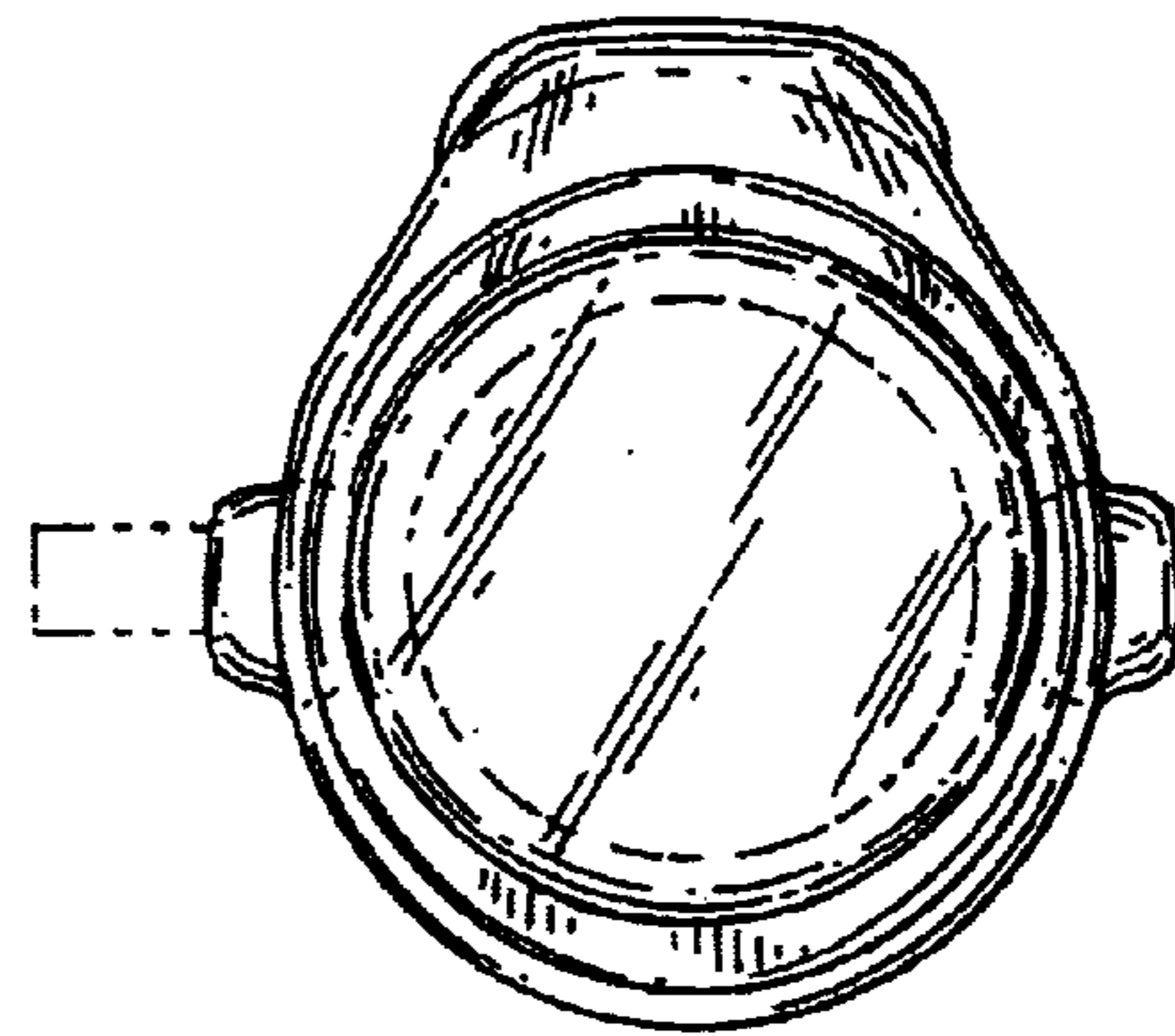

FIG. 3



*FIG. 4*



*FIG. 5*

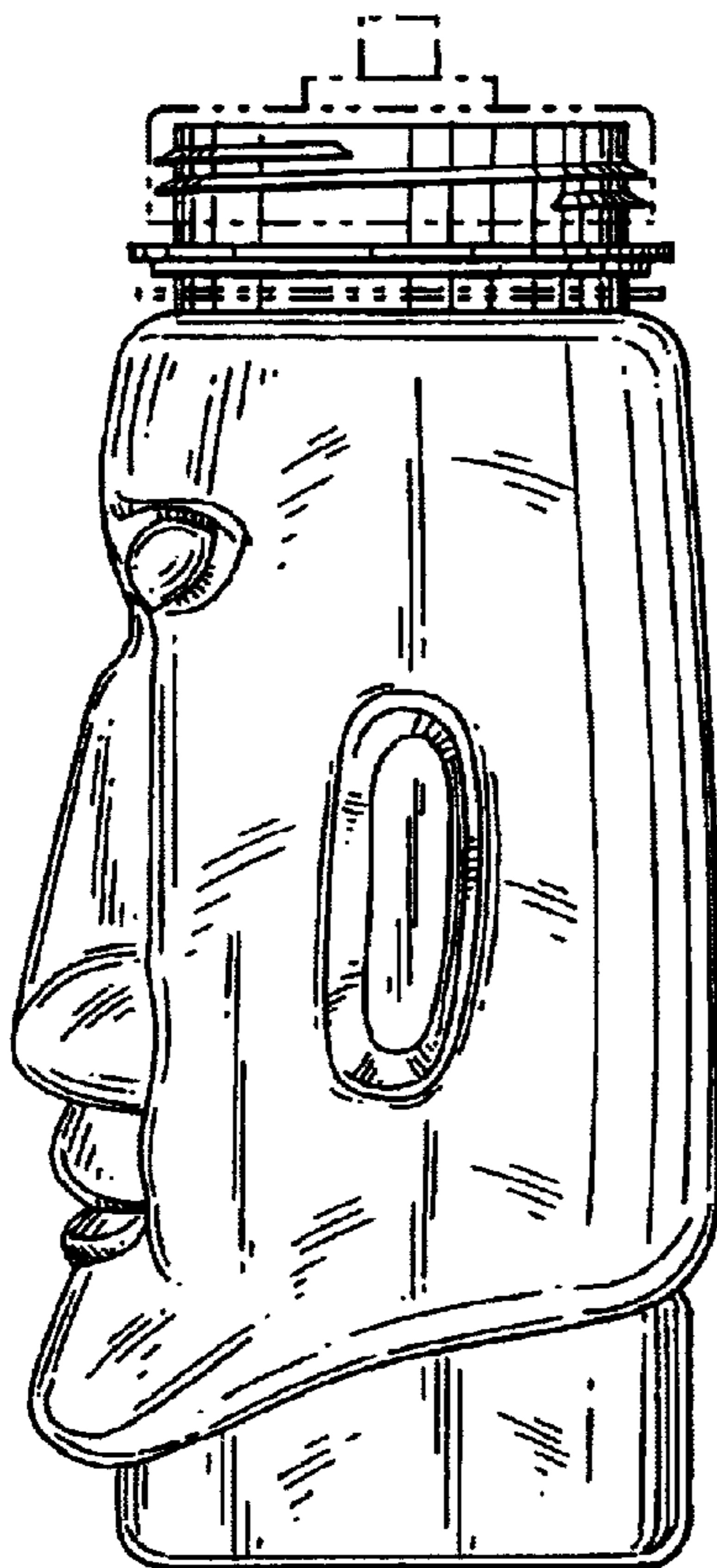

*FIG. 6*

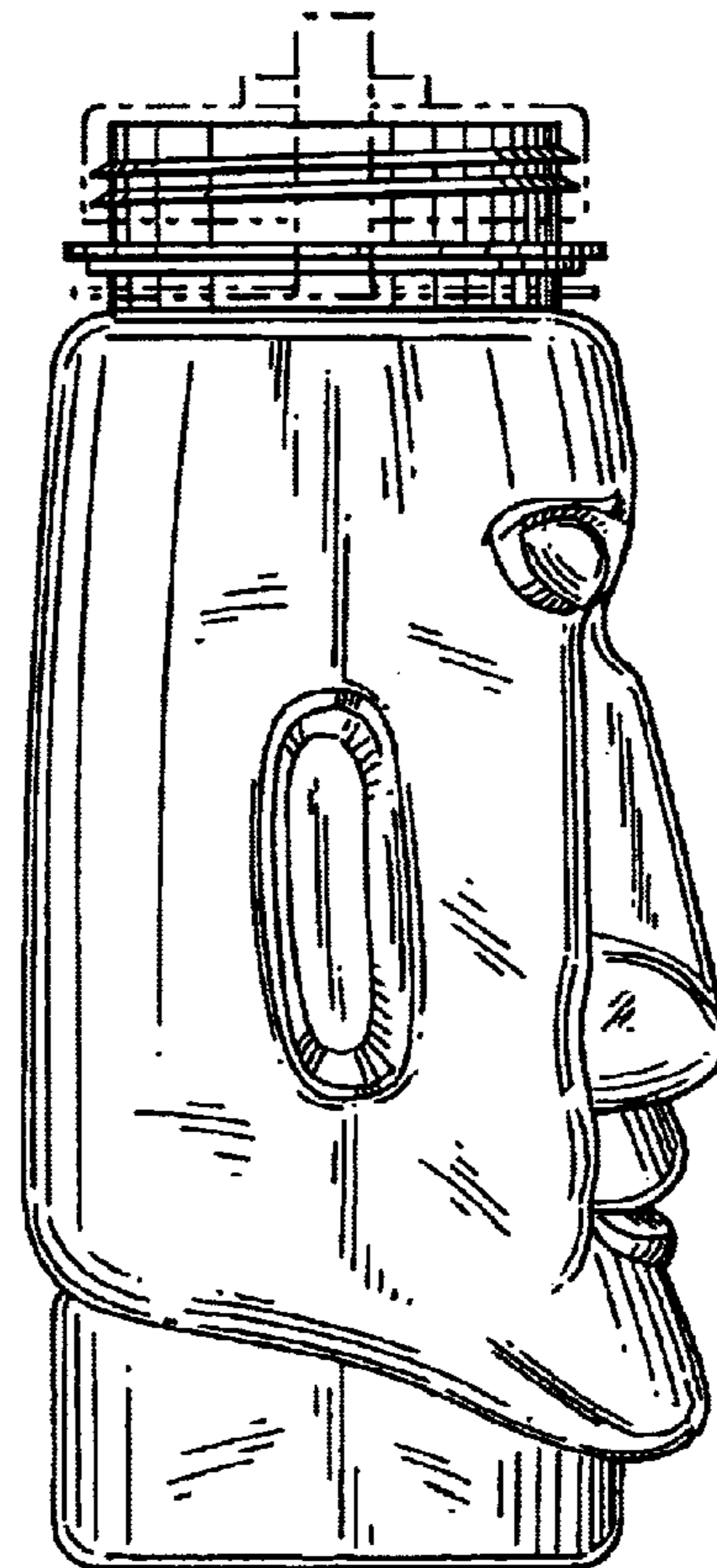

*FIG. 7*