

US00D518998S

(12) **United States Design Patent**
Lipson

(10) **Patent No.:** **US D518,998 S**

(45) **Date of Patent:** **** Apr. 18, 2006**

(54) **ICE CREAM CONE SPORTS BOTTLE**

(76) Inventor: **Erik Lipson**, 530 S. Second St.,
GU-11, Philadelphia, PA (US) 19147

(**) Term: **14 Years**

(21) Appl. No.: **29/182,682**

(22) Filed: **May 30, 2003**

(51) **LOC (8) Cl.** **07-01**

(52) **U.S. Cl.** **D7/515; D7/507; D7/510**

(58) **Field of Classification Search** D7/506,
D7/507, 509, 514, 515, 510, 511, 625, 623;
D9/643; 220/703, 705, 710, 717; 401/126,
401/129; 215/387, 388, 382; D1/116, 102,
D1/118; D34/4; D30/160

See application file for complete search history.

(56) **References Cited**

U.S. PATENT DOCUMENTS

D246,509 S	*	11/1977	Hytken	D9/302
D268,059 S	*	2/1983	Kracke	D34/4
D284,726 S	*	7/1986	Appel	D7/511
D395,230 S	*	6/1998	Slater	D9/329
D429,601 S	*	8/2000	Lipson	D7/507
D429,603 S	*	8/2000	Lipson	D7/507
D431,417 S	*	10/2000	Lipson	D7/507

D453,093 S	*	1/2002	Lipson	D7/507
D460,321 S	*	7/2002	Ross	D7/506
D460,587 S	*	7/2002	Huettner	D30/160
D469,306 S	*	1/2003	Lipson	D7/507
D475,892 S	*	6/2003	Andres et al.	D7/515
D486,691 S	*	2/2004	Hurlbut	D7/515
D490,588 S	*	6/2004	Baker	D1/116
D493,667 S	*	8/2004	Lipson	D7/515

* cited by examiner

Primary Examiner—M. N. Pandozzi

(74) *Attorney, Agent, or Firm*—Gifford, Krass, Groh,
Sprinkle, Anderson & Citkowski, P.C.

(57) **CLAIM**

I claim the ornamental design for an ice cream cone sports bottle, as shown.

DESCRIPTION

FIG. 1 is a front elevational view of an ice cream cone bottle showing my new design;

FIG. 2 is a right side view of the sports bottle of FIG. 1;

FIG. 3 is a left side view of the sports bottle of FIG. 1;

FIG. 4 is a rear view of the sports bottle of FIG. 1;

FIG. 5 is a top view of the sports bottle of FIG. 1; and,

FIG. 6 is a bottom view of the sports bottle of FIG. 1.

1 Claim, 2 Drawing Sheets

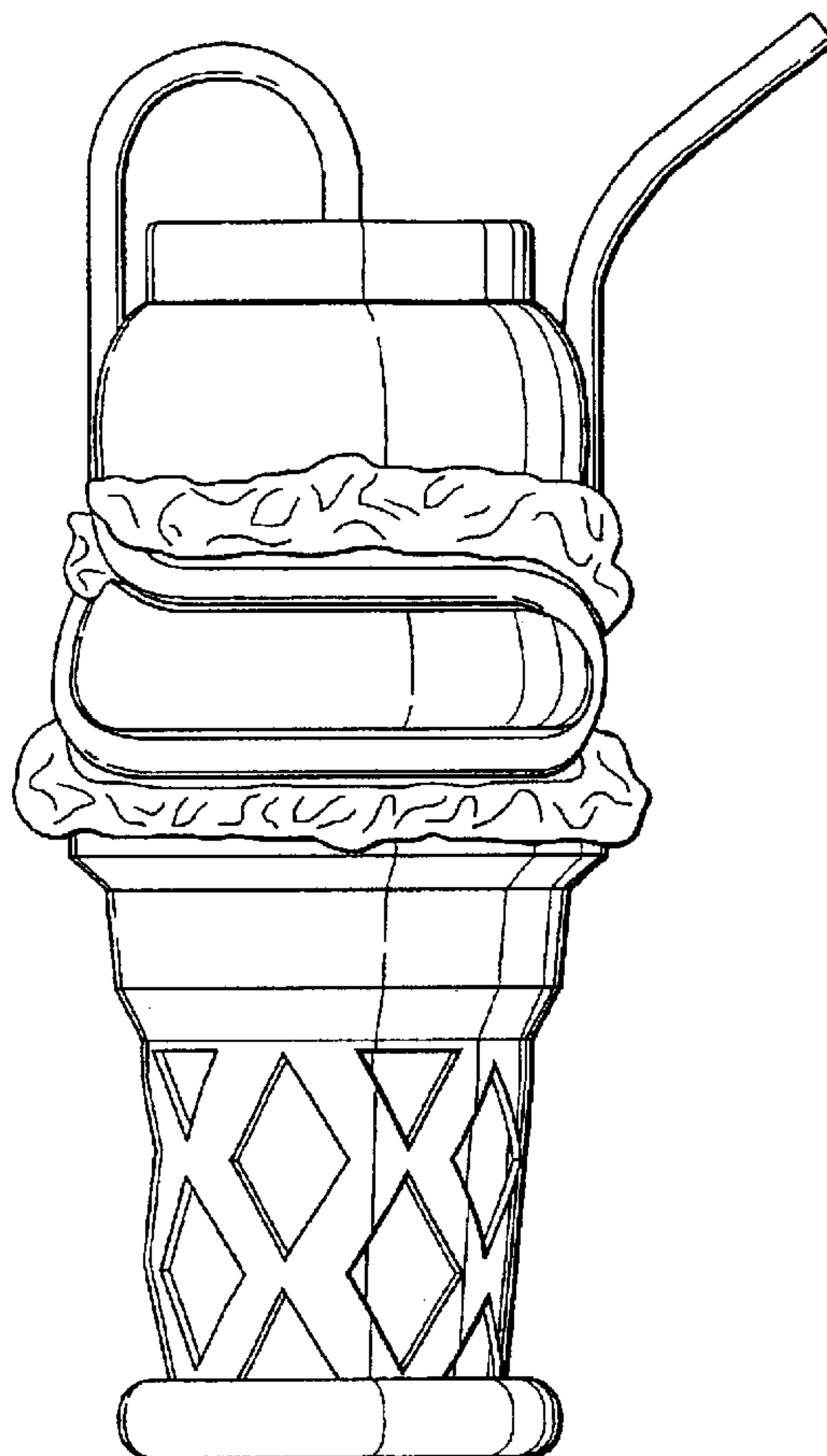

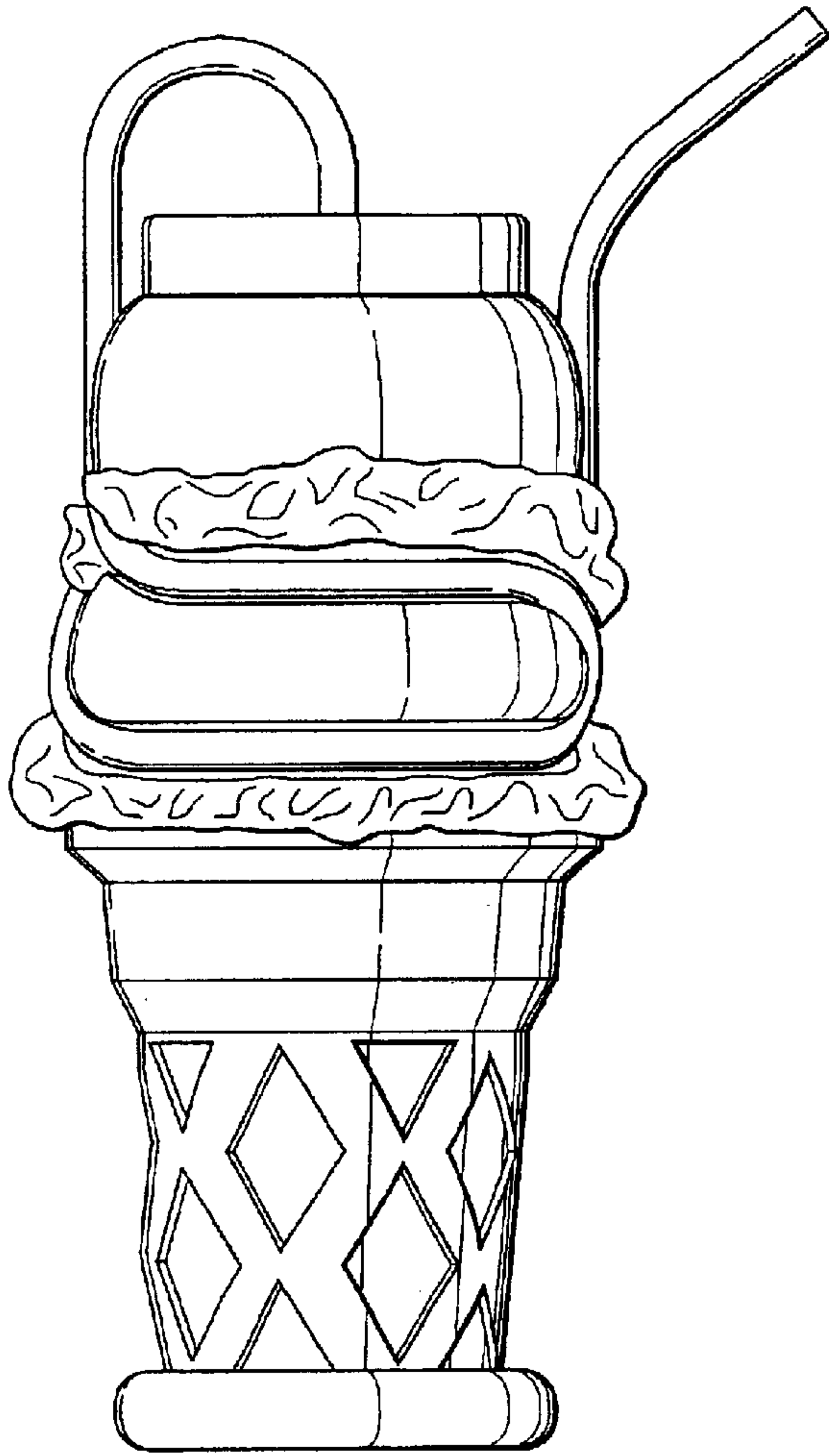

FIG - 1

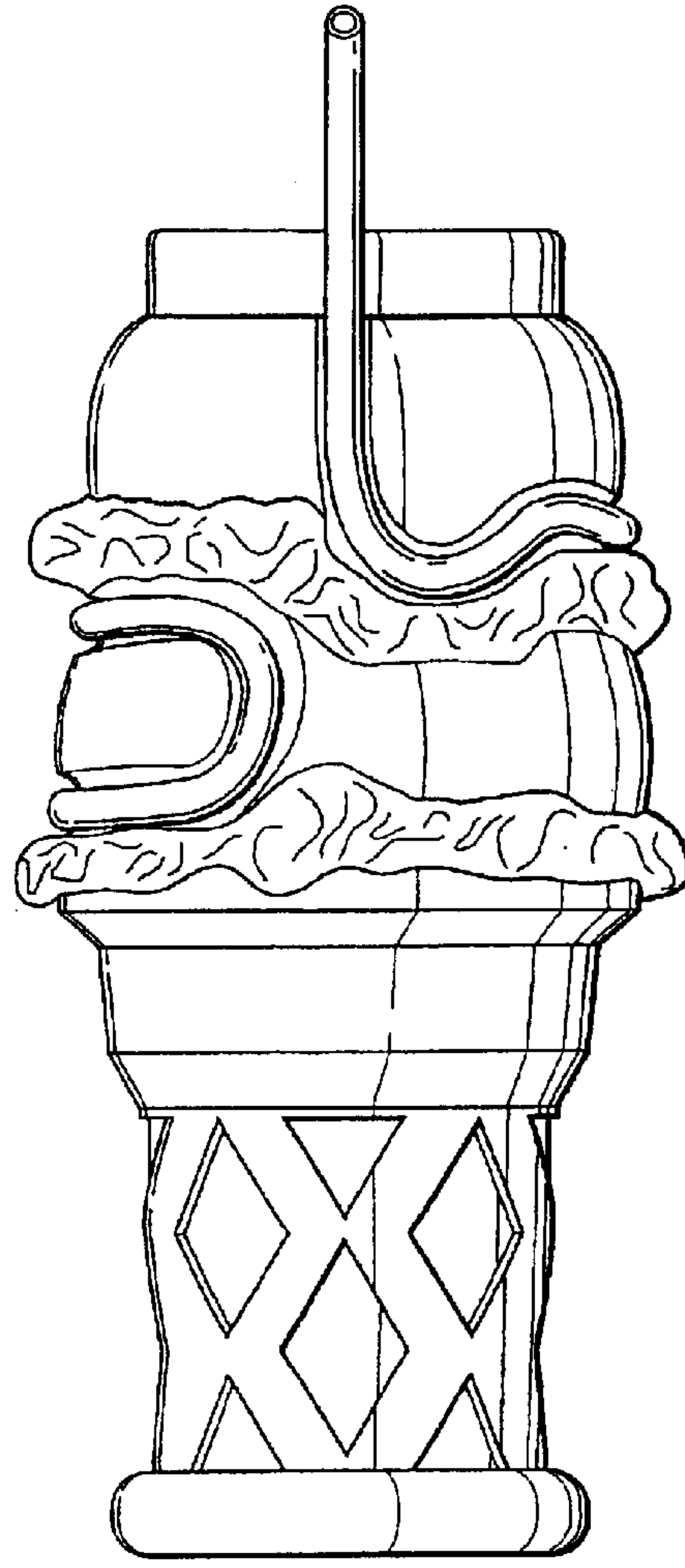

FIG - 2

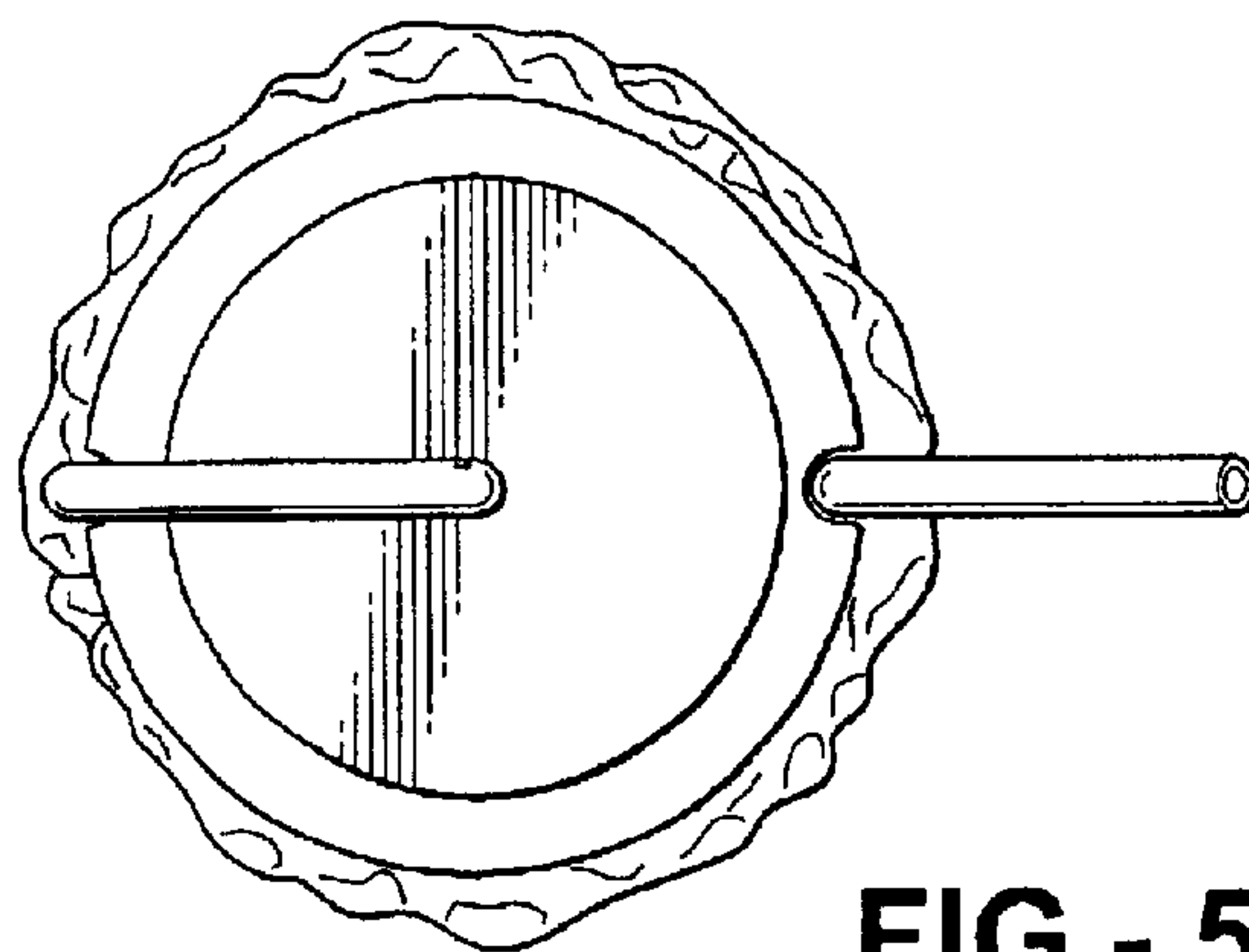

FIG - 5

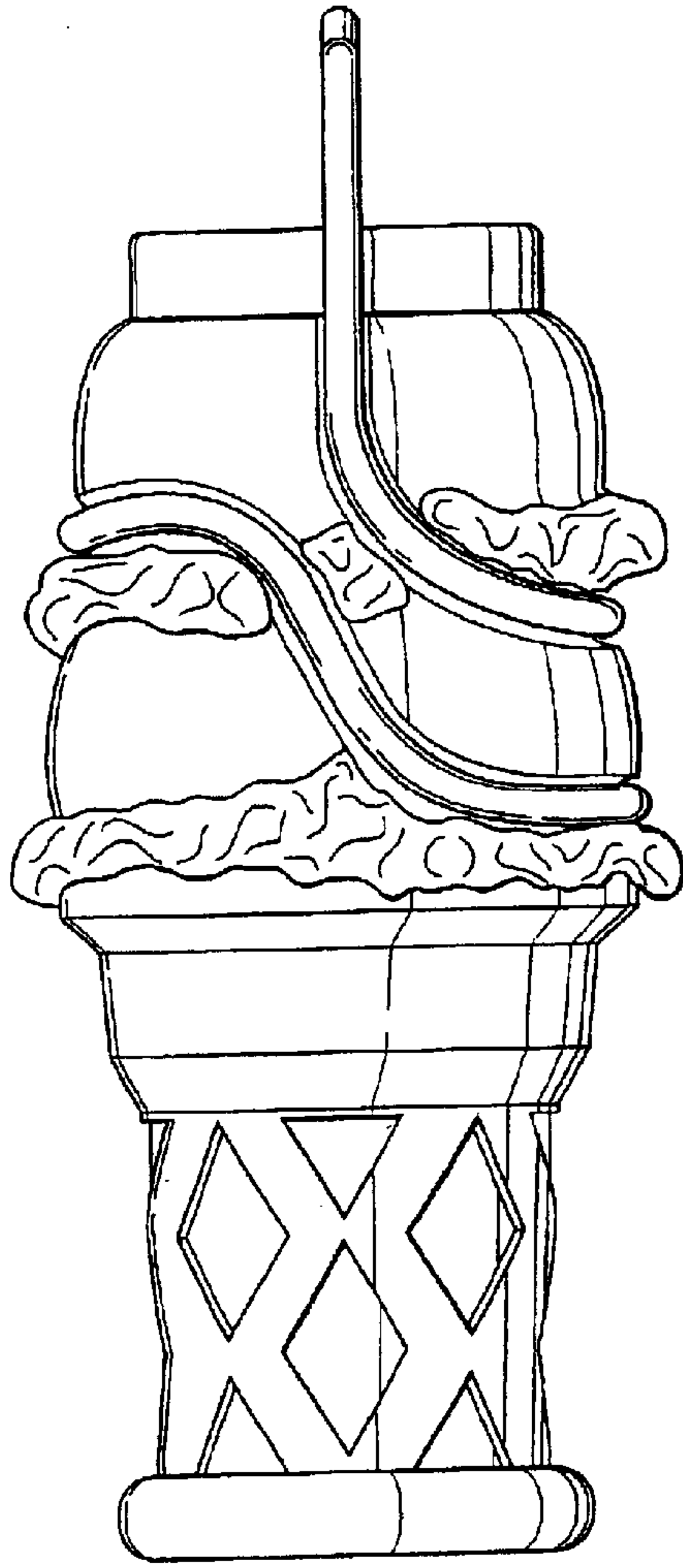

FIG - 3

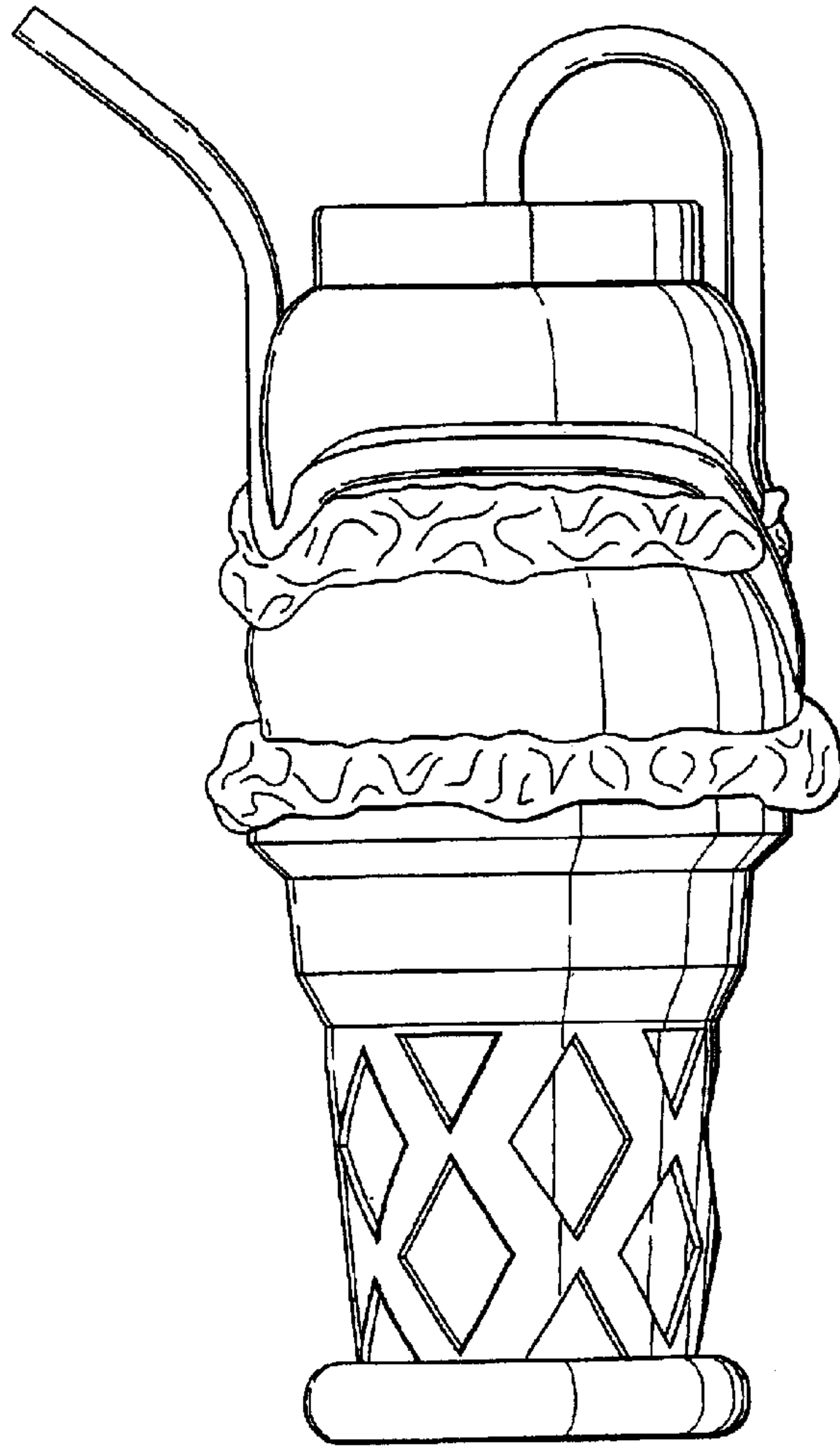

FIG - 4

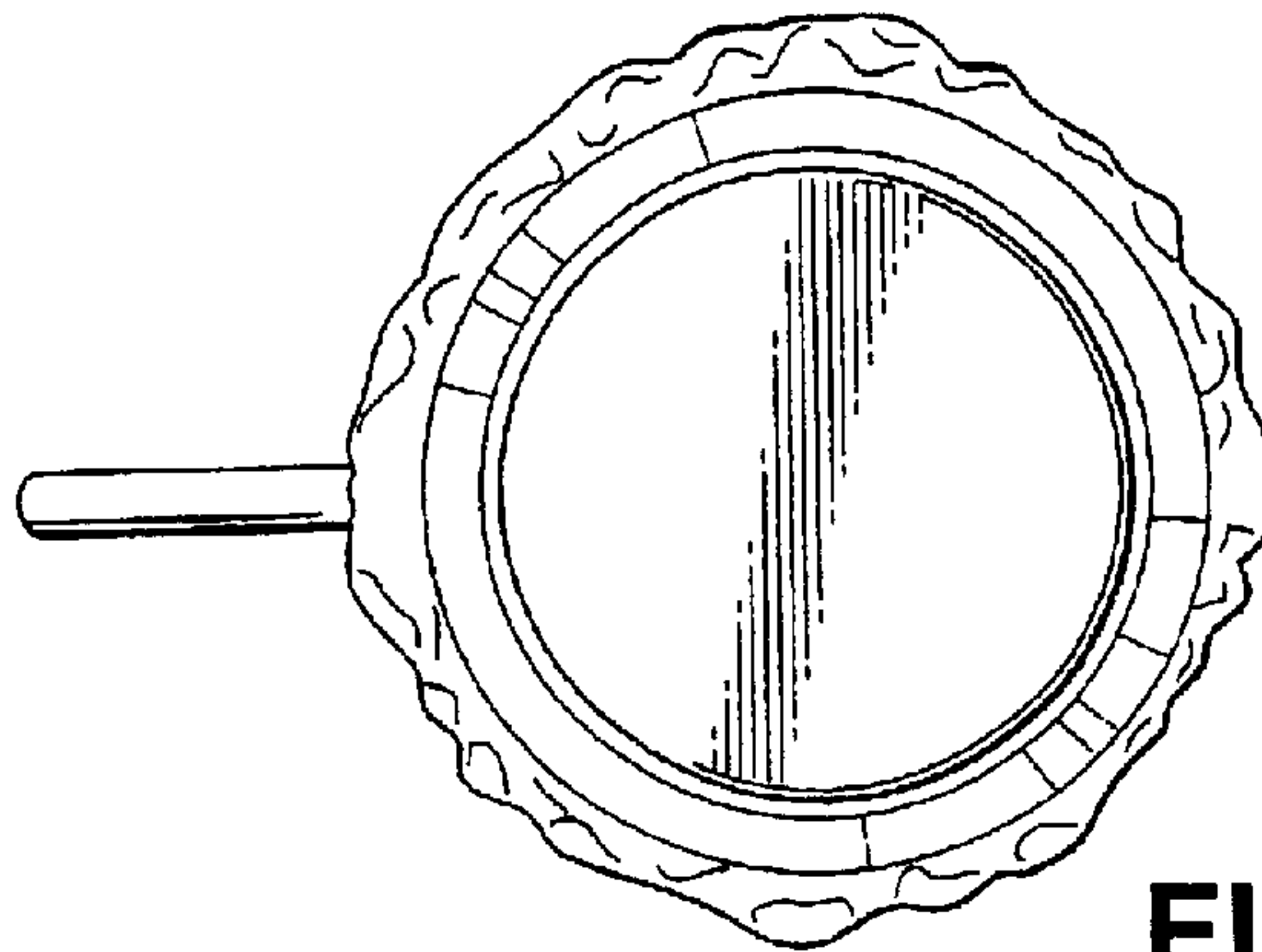

FIG - 6