



US00D518603S

(12) **United States Design Patent**
Dittmer et al.

(10) **Patent No.:** **US D518,603 S**

(45) **Date of Patent:** **** Apr. 4, 2006**

(54) **COMPACT**

(75) Inventors: **Jay R. Dittmer**, Ada, MI (US); **Eric N. Grossnickle**, Ada, MI (US)

(73) Assignee: **Access Business Group International LLC**, Ada, MI (US)

(**) Term: **14 Years**

(21) Appl. No.: **29/218,938**

(22) Filed: **Dec. 9, 2004**

(51) **LOC (8) Cl.** **28-03**

(52) **U.S. Cl.** **D28/83**

(58) **Field of Classification Search** D28/76,
D28/77, 78, 81, 83; 132/293-307, 314-318;
206/581, 823

See application file for complete search history.

(56) **References Cited**

U.S. PATENT DOCUMENTS

D93,317 S * 9/1934 Zell D28/78
3,776,245 A * 12/1973 Hayes et al. 132/304
D267,983 S * 2/1983 Cheung D28/83

D281,968 S * 12/1985 Thiele et al. D28/83
D307,810 S * 5/1990 Gavin D28/83
D491,315 S 6/2004 Dittmer et al.
D496,133 S 9/2004 Dittmer et al.

* cited by examiner

Primary Examiner—Jennifer Rivard

(74) *Attorney, Agent, or Firm*—Warner Norcross & Judd

(57) **CLAIM**

The ornamental design for a compact, as shown and described.

DESCRIPTION

FIG. 1 is a top perspective view of the compact embodying the new design;

FIG. 2 is a bottom perspective view thereof;

FIG. 3 is a left side elevational view, the right side being a mirror image thereof;

FIG. 4 is a rear elevational view thereof;

FIG. 5 is a front elevational view thereof;

FIG. 6 is a top plan view thereof; and,

FIG. 7 is a bottom plan view thereof.

1 Claim, 3 Drawing Sheets

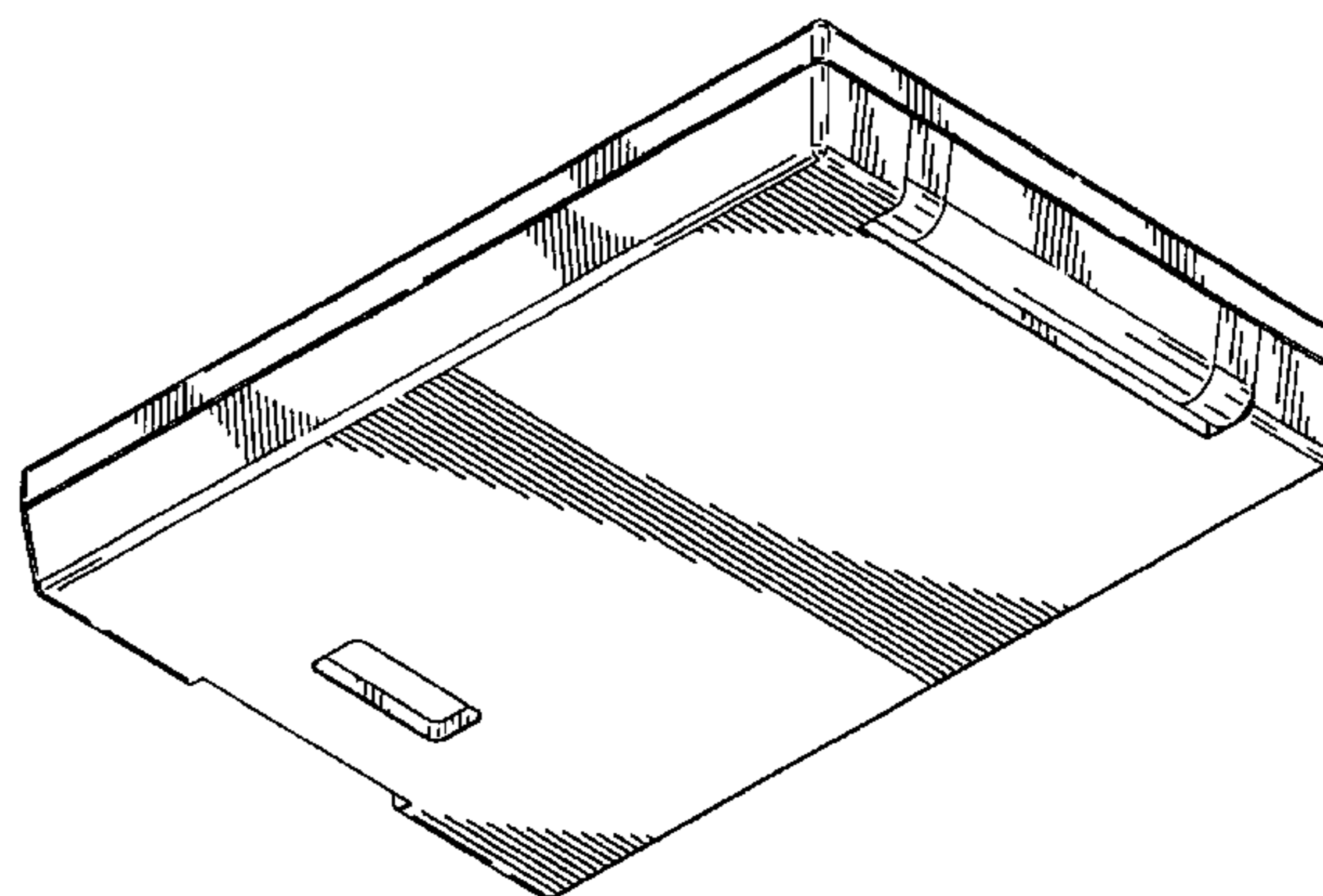
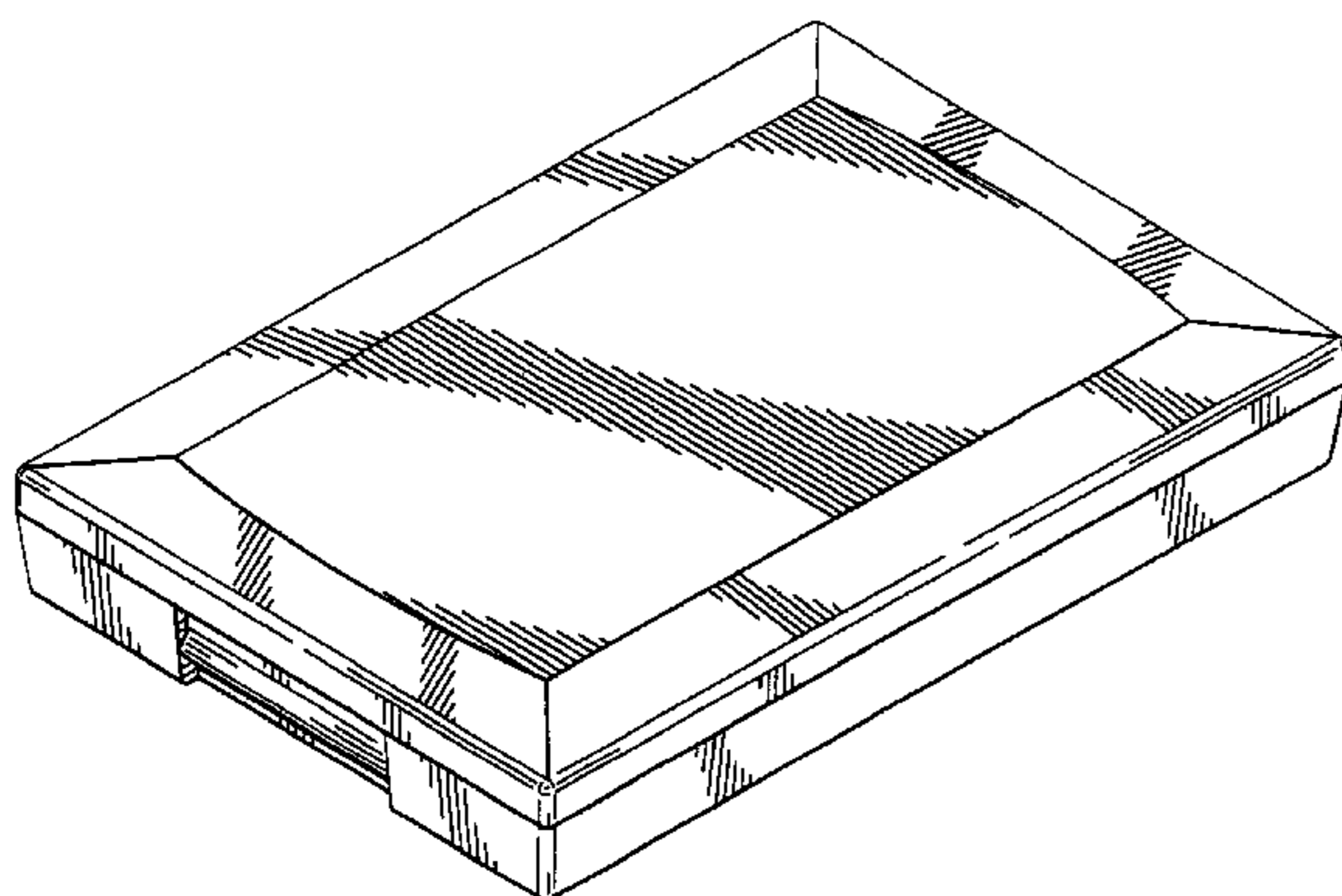

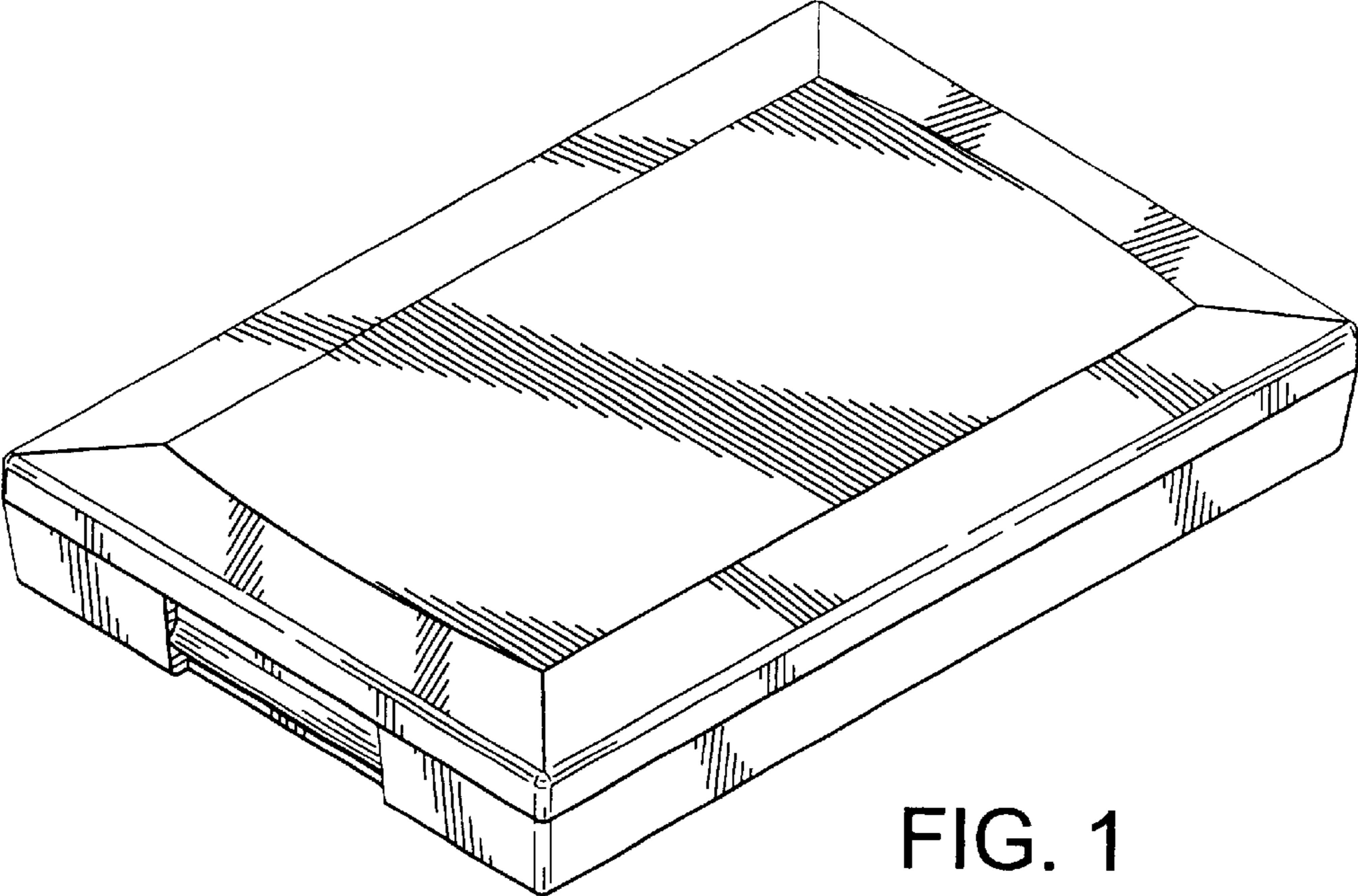

FIG. 1

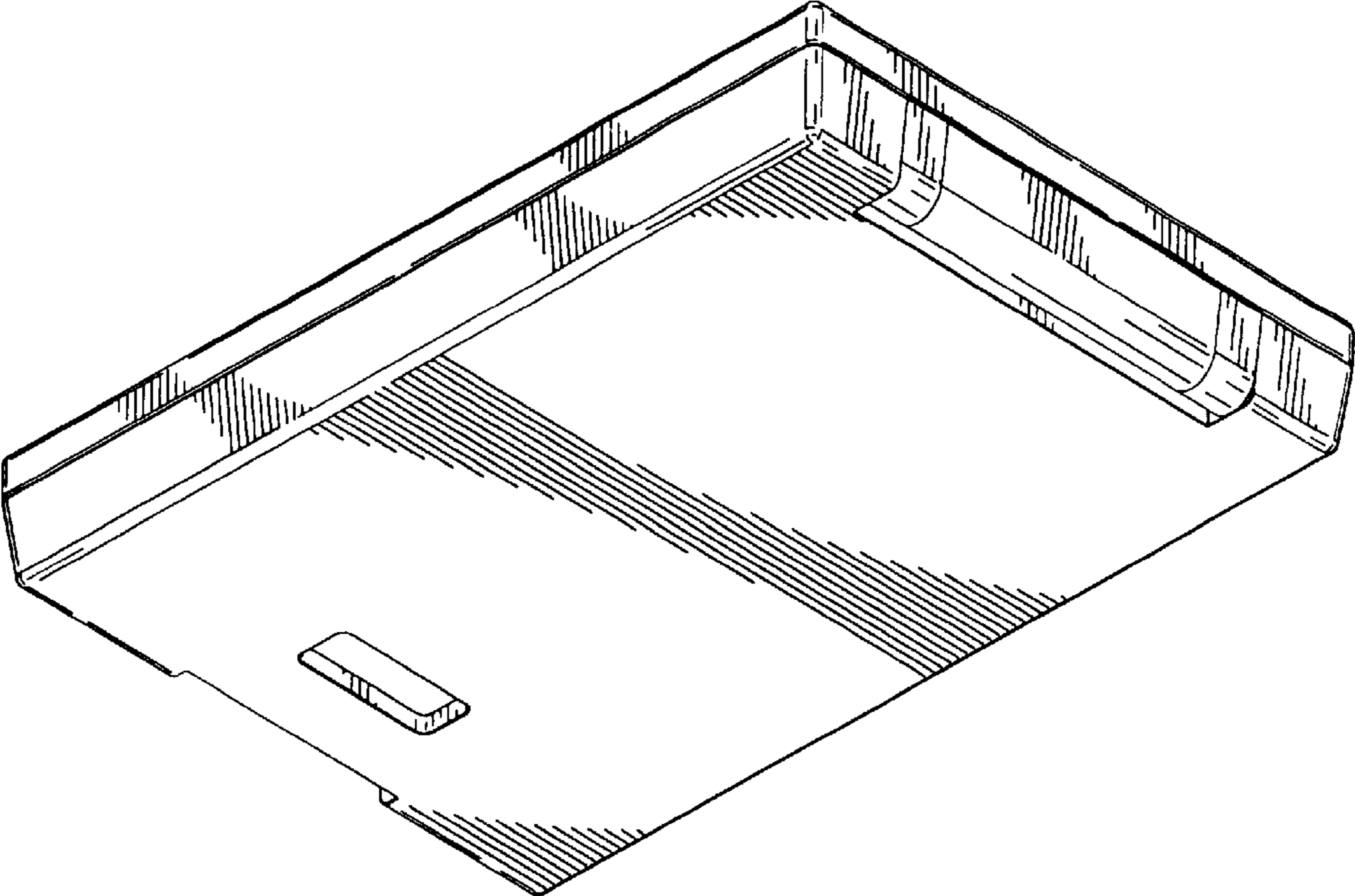

FIG. 2

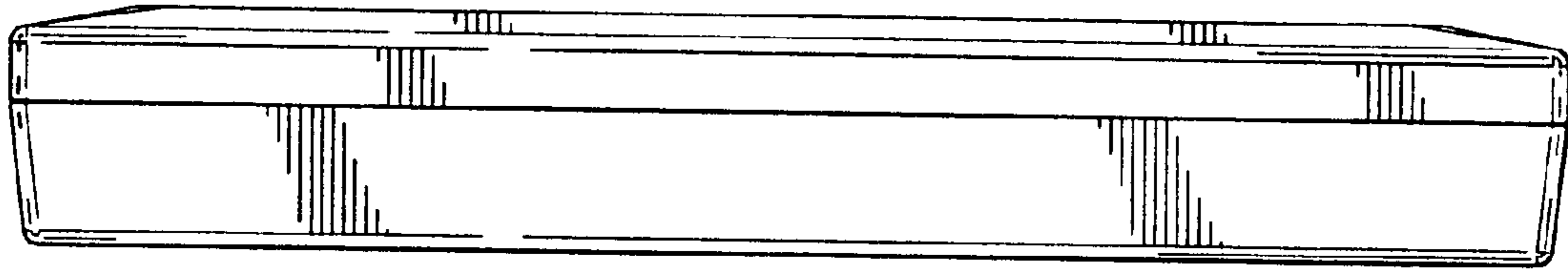

FIG. 3

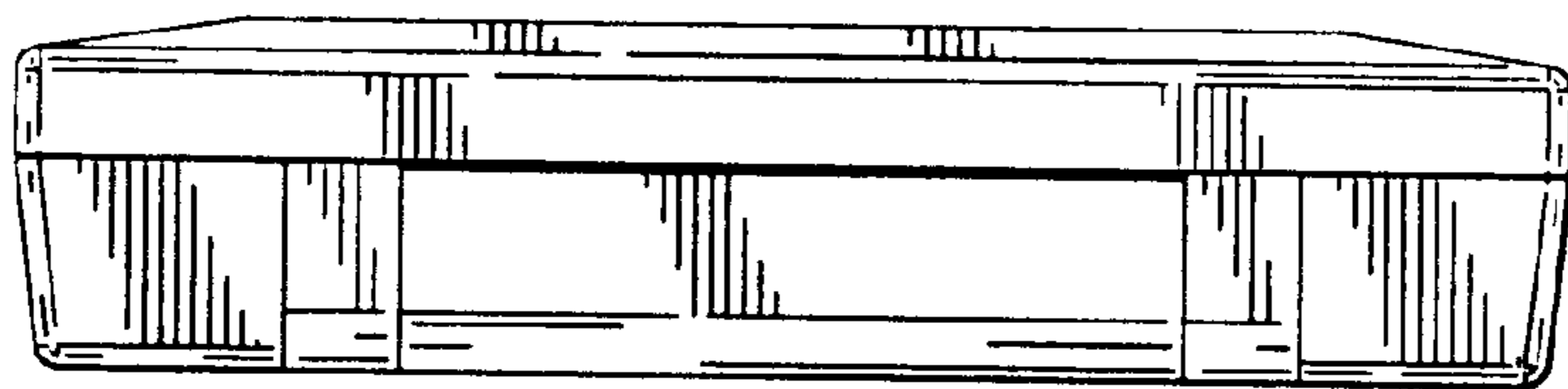

FIG. 4

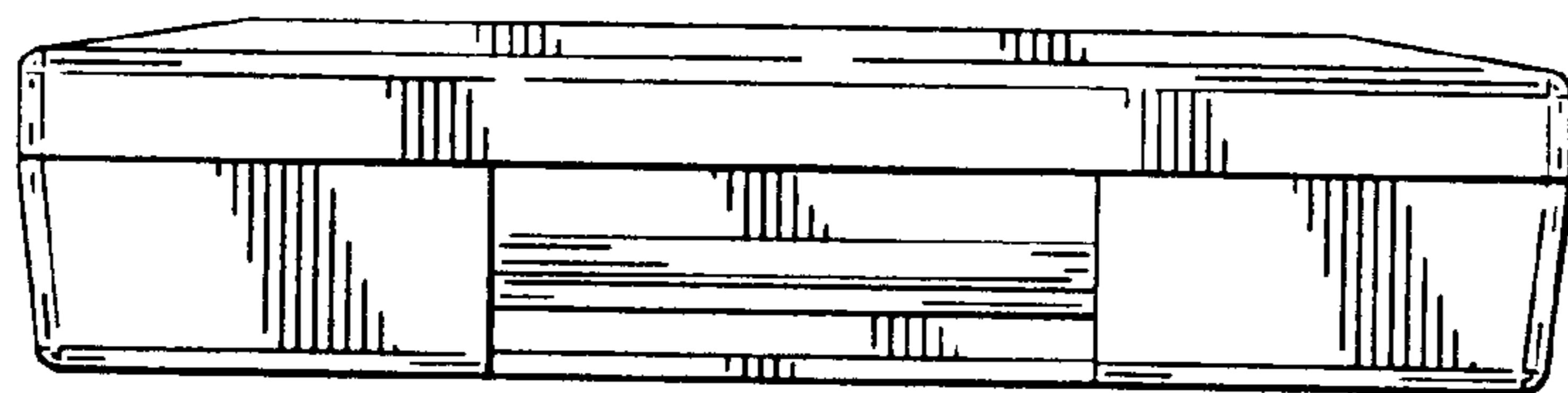

FIG. 5

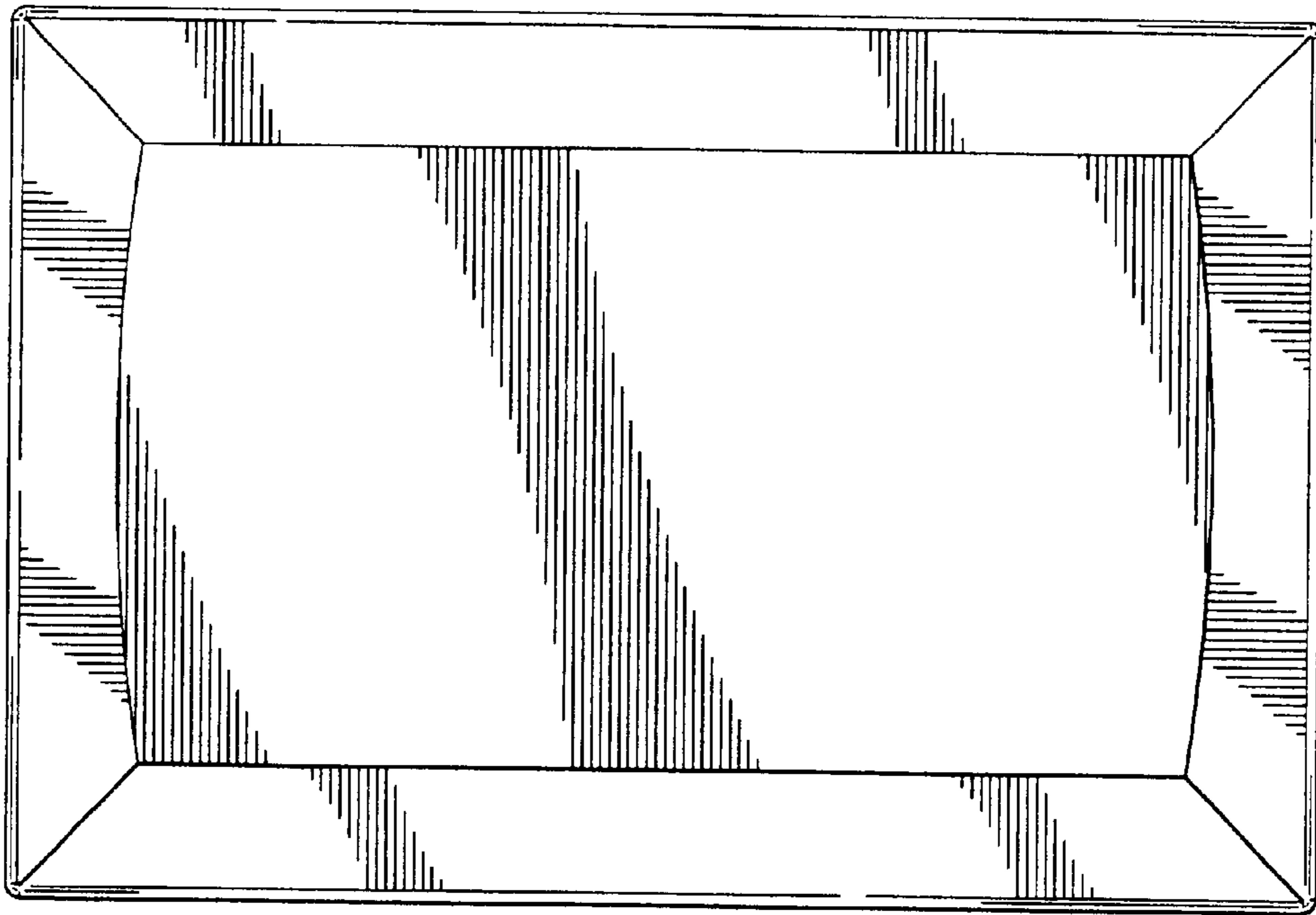

FIG. 6

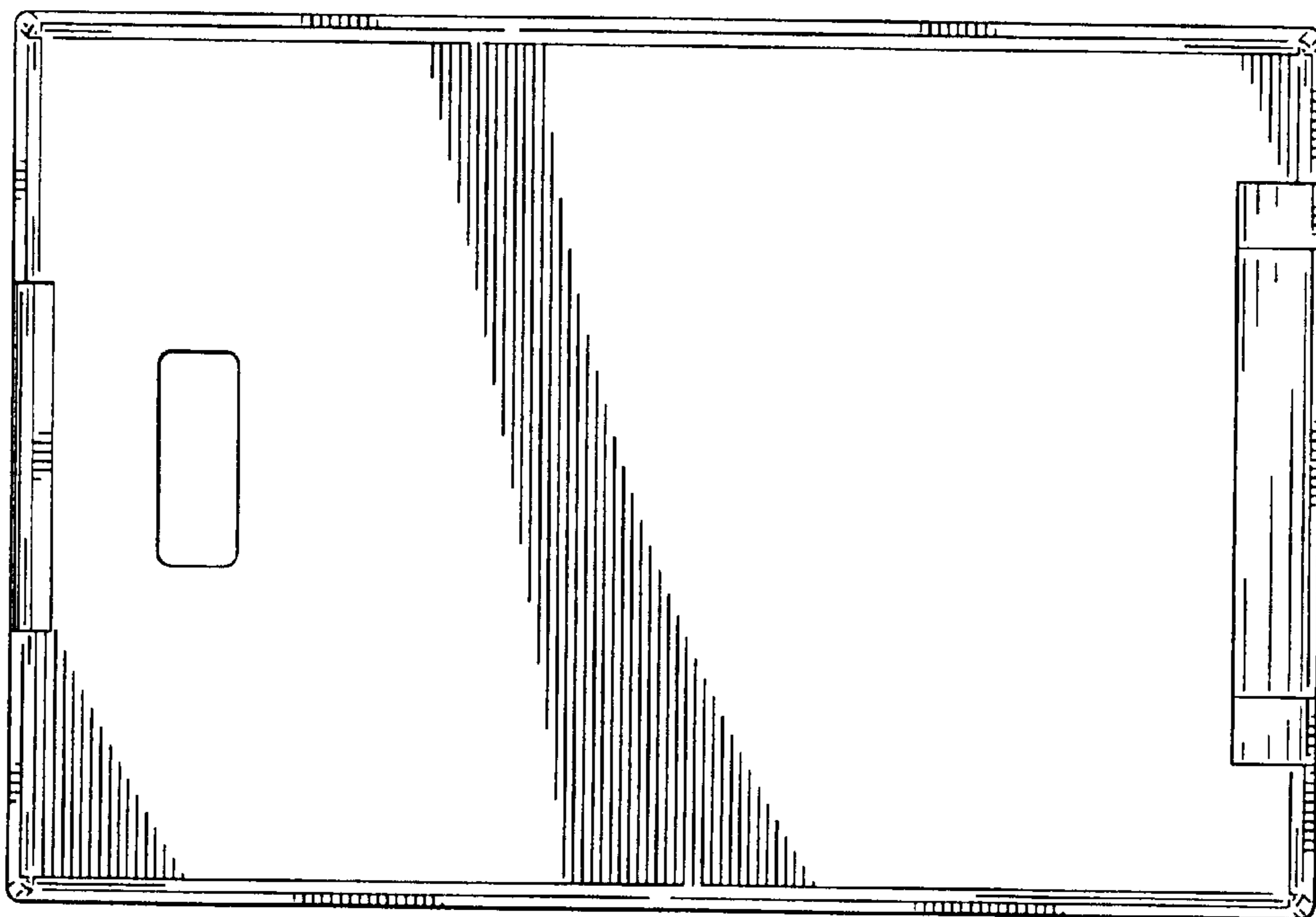

FIG. 7