



US00D518479S

(12) **United States Design Patent**
Skulley

(10) **Patent No.:** **US D518,479 S**

(45) **Date of Patent:** **** Apr. 4, 2006**

(54) **MICROPHONE BOOM FOR A COMMUNICATIONS HEADSET**

(75) Inventor: **Gerald W. Skulley**, Aptos, CA (US)

(73) Assignee: **Plantronics, Inc.**, Santa Cruz, CA (US)

(**) Term: **14 Years**

(21) Appl. No.: **29/229,901**

(22) Filed: **May 12, 2005**

Related U.S. Application Data

(63) Continuation of application No. 29/220,690, filed on Jan. 4, 2005.

(51) **LOC (8) Cl.** **14-01**

(52) **U.S. Cl.** **D14/225**

(58) **Field of Classification Search** D14/205, D14/206, 223, 224, 225, 226, 227, 228, 229, D14/240; 181/128, 137, 158, 196, 242, 22; 379/430, 431, 432, 433, 434, 444; 381/370, 381/374, 375, 376, 377, 378, 379, 380, 381, 381/382, 385

See application file for complete search history.

(56) **References Cited**

U.S. PATENT DOCUMENTS

D233,444	S	*	10/1974	Christian	D14/206
4,926,961	A	*	5/1990	Gatley et al.	181/22
D371,133	S	*	6/1996	Andrea	D14/206
5,960,094	A	*	9/1999	Jensen et al.	381/381
D447,472	S	*	9/2001	McGugan	D14/225
6,560,346	B1	*	5/2003	Ohta et al.	381/382
D476,645	S	*	7/2003	Padala et al.	D14/223
D497,156	S	*	10/2004	Bauman et al.	D14/225
D505,413	S	*	5/2005	Skulley et al.	D14/223

* cited by examiner

Primary Examiner—Paula A. Greene

(57) **CLAIM**

The ornamental design for microphone boom for a communications headset, as shown and described.

DESCRIPTION

FIG. 1 is an upper front right perspective view of a microphone boom for a communications headset, the microphone boom of the communications headset being shown herein in an exemplary storage position for purposes of clarity, the broken line drawings of a headband and speaker of the communications headset in the drawings herein are for illustrative purposes only and form no part of the claimed design.

FIG. 2 is a front elevational view of the microphone boom of FIG. 1.

FIG. 3 is a rear elevational view of the microphone boom of FIG. 1.

FIG. 4 is a right side elevational view of the microphone boom of FIG. 1.

FIG. 5 is a top plan view of the microphone boom of FIG. 1.

FIG. 6 is a bottom plan view of the microphone boom of FIG. 1.

FIG. 7 is an upper front right perspective view of a second embodiment of the microphone boom for a communications headset, the difference being the microphone disposed at the end of the microphone boom;

FIG. 8 is a front elevational view of the microphone boom of FIG. 7.

FIG. 9 is a rear elevational view of the microphone boom of FIG. 7.

FIG. 10 is a right side elevational view of the microphone boom of FIG. 7.

FIG. 11 is a top plan view of the microphone boom of FIG. 7; and,

FIG. 12 is a bottom plan view of the microphone boom of FIG. 7.

1 Claim, 6 Drawing Sheets

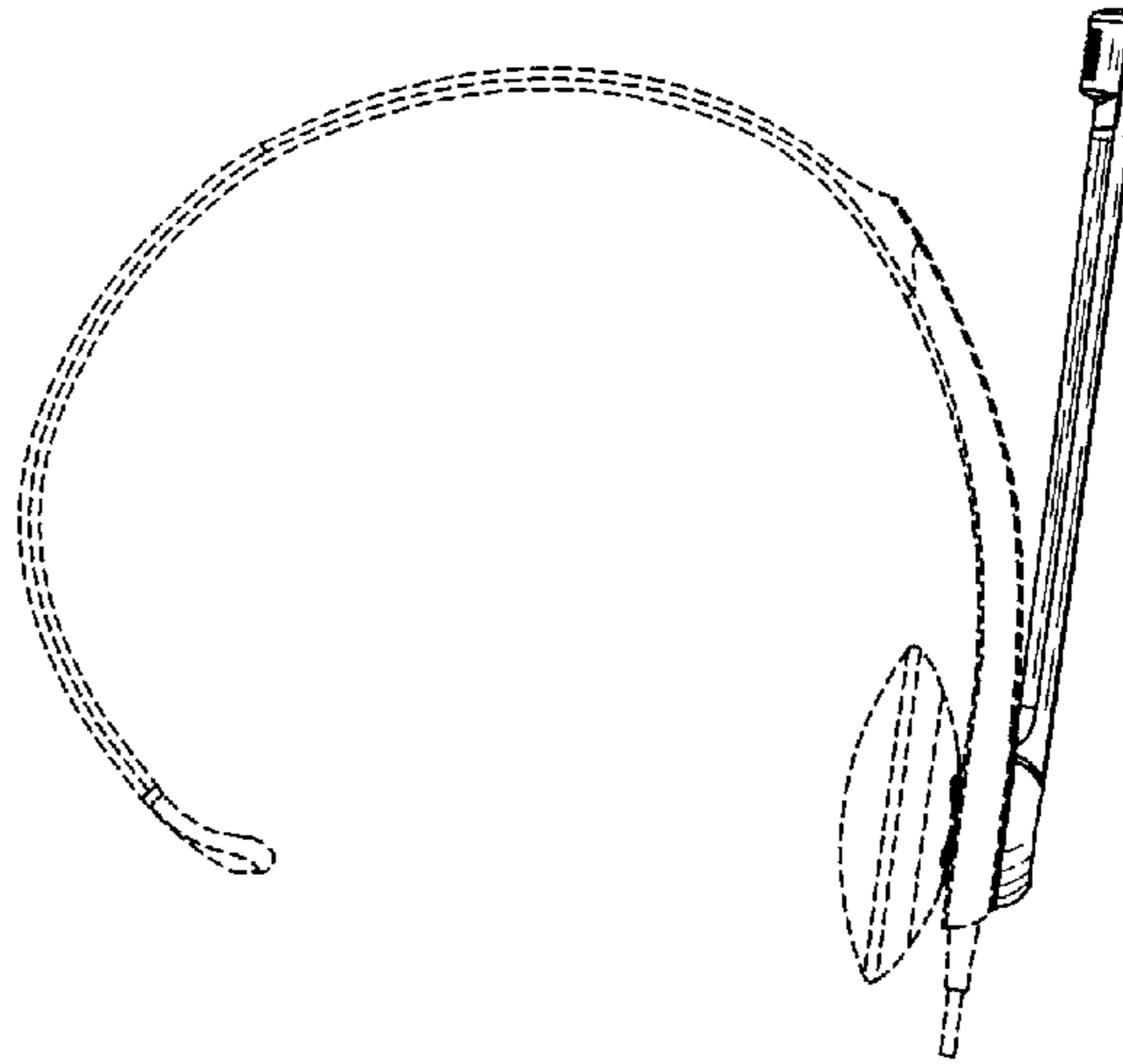
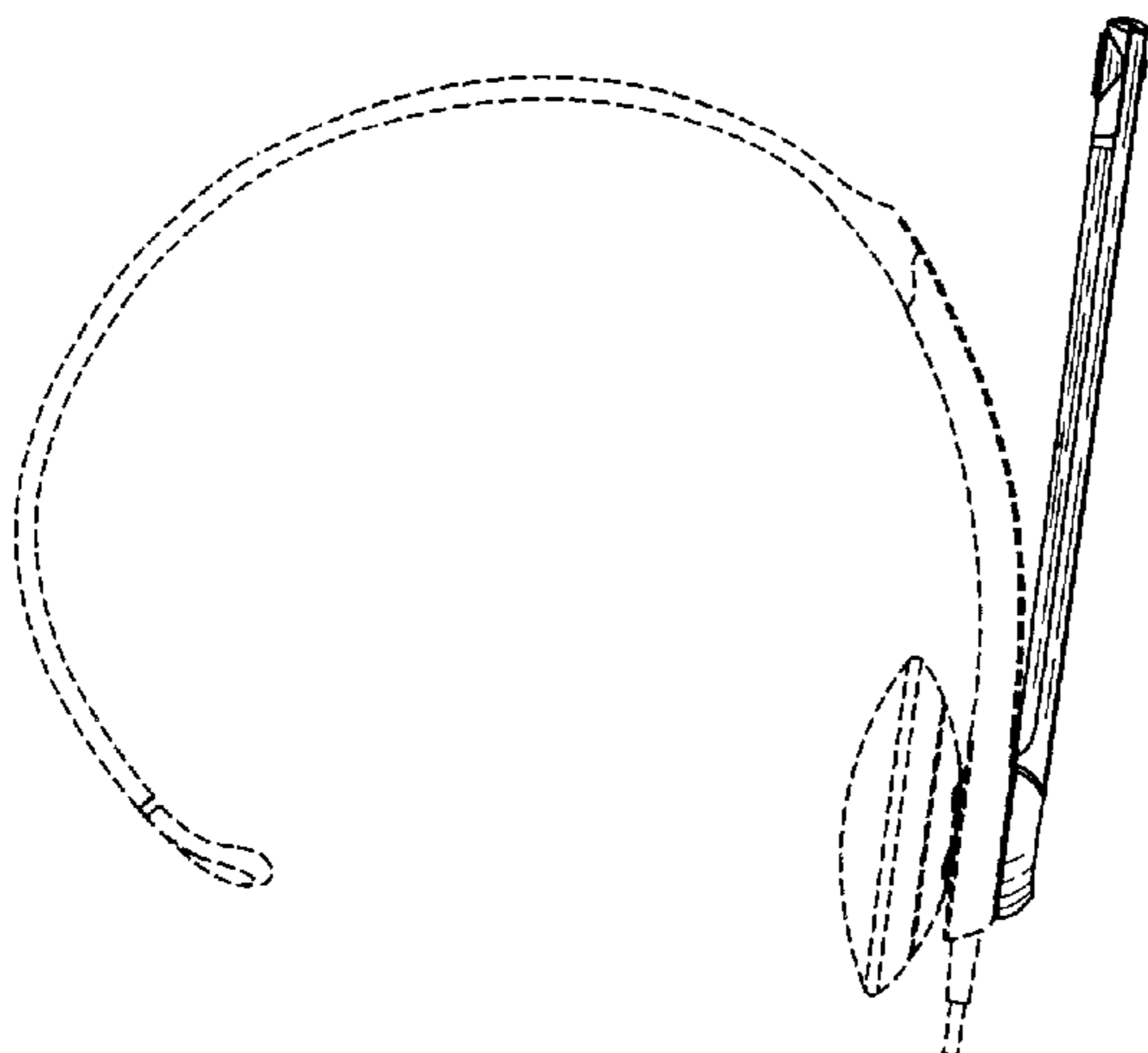

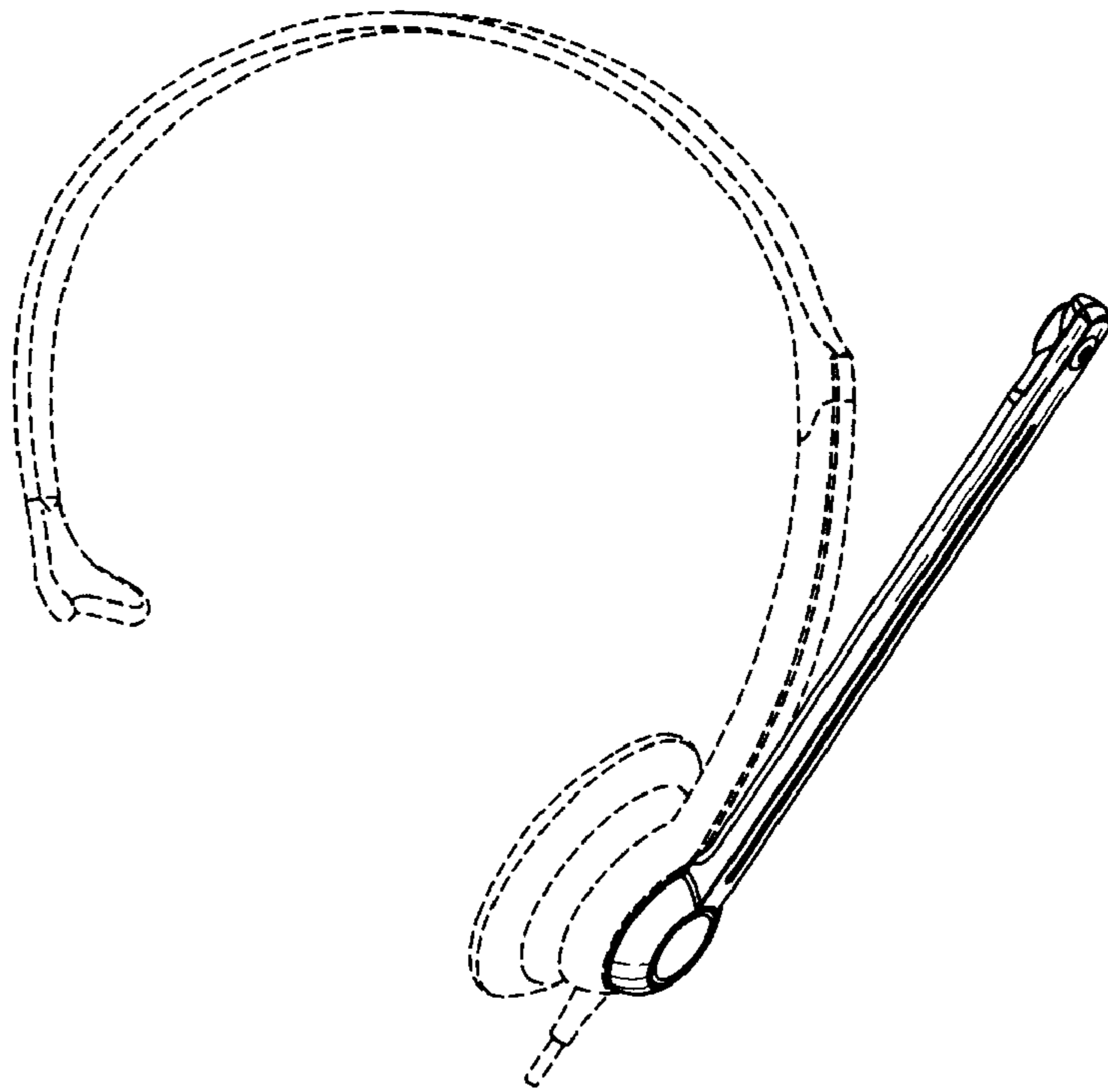

FIG. 1

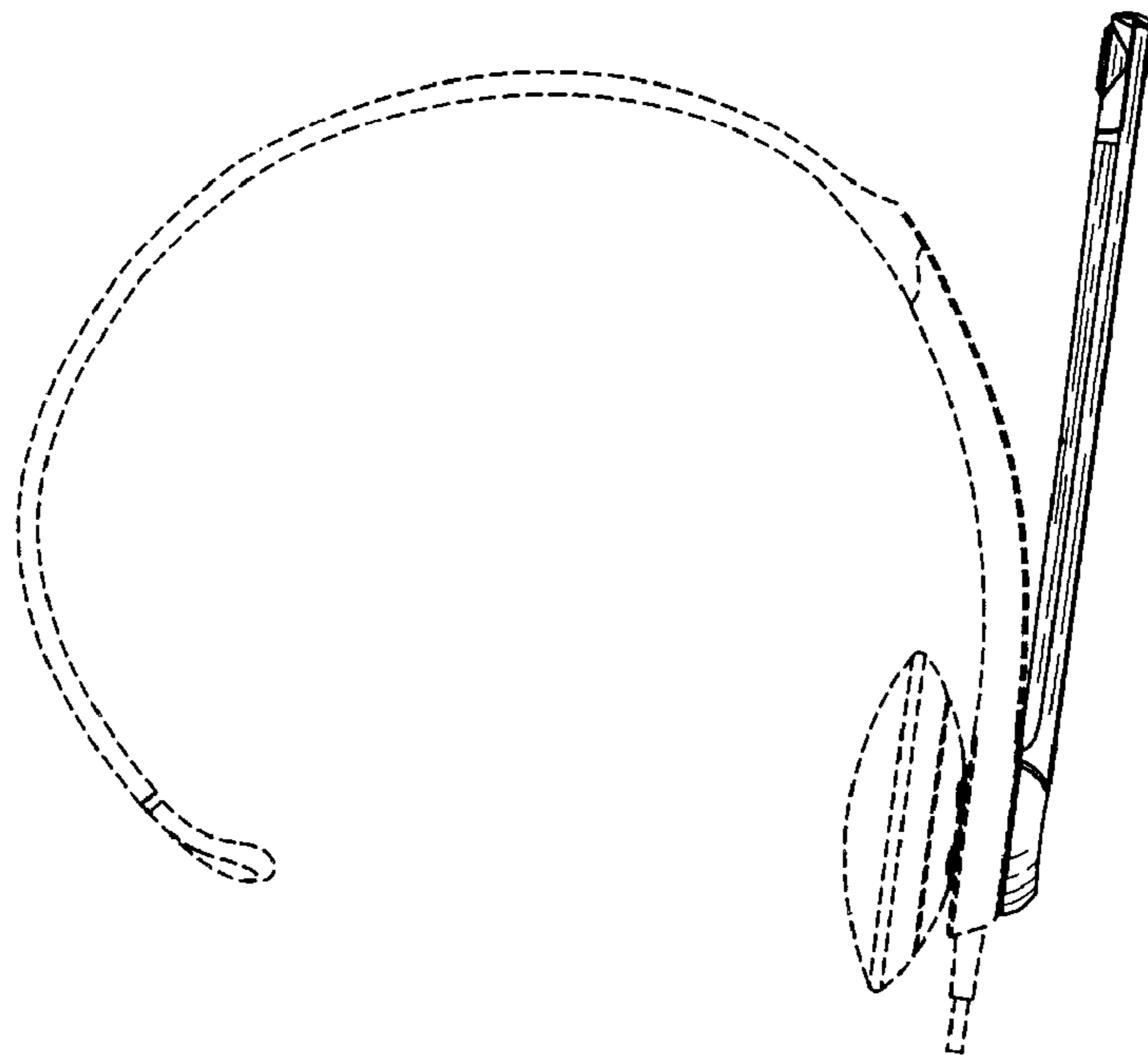

FIG. 2

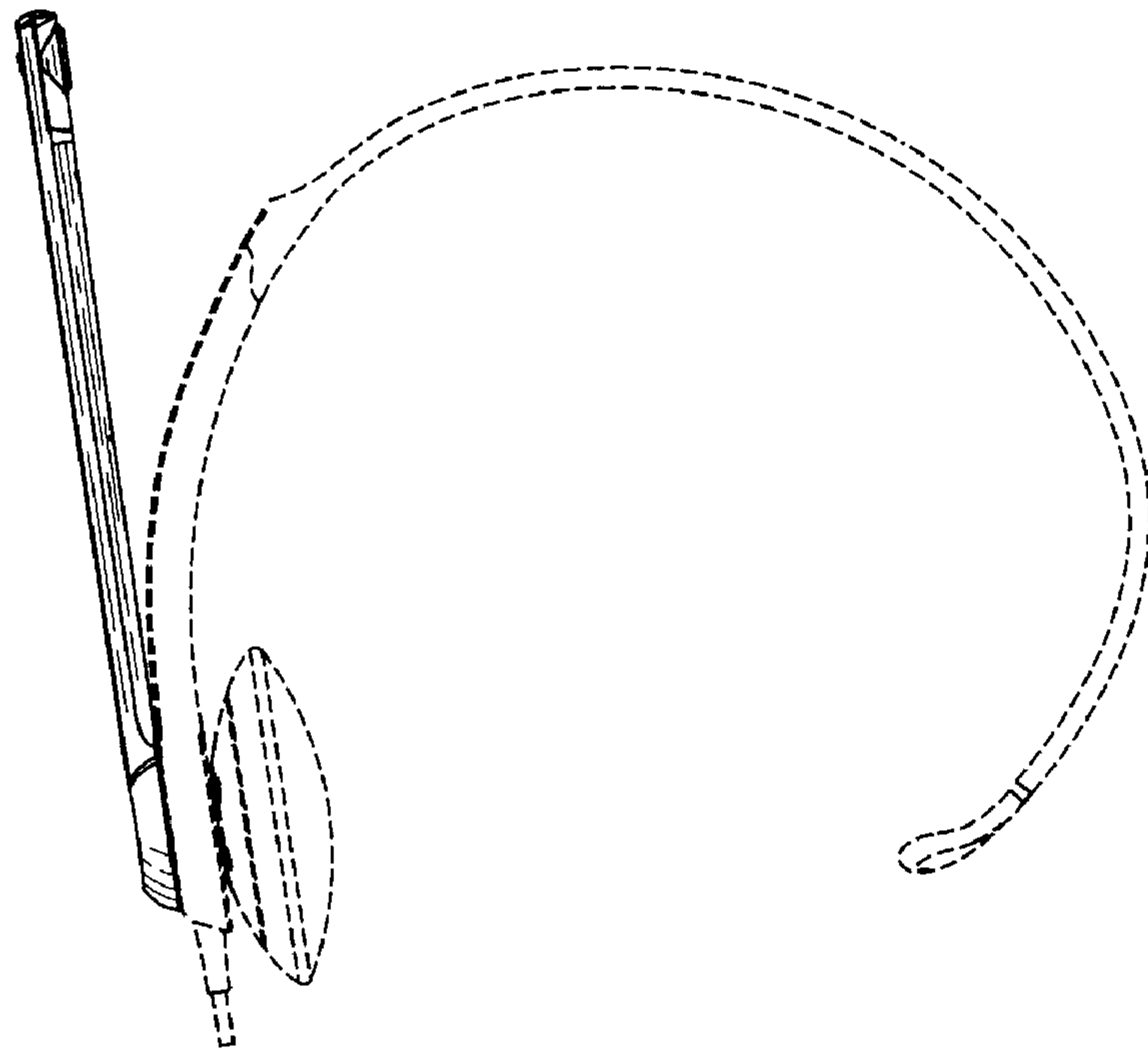

FIG. 3

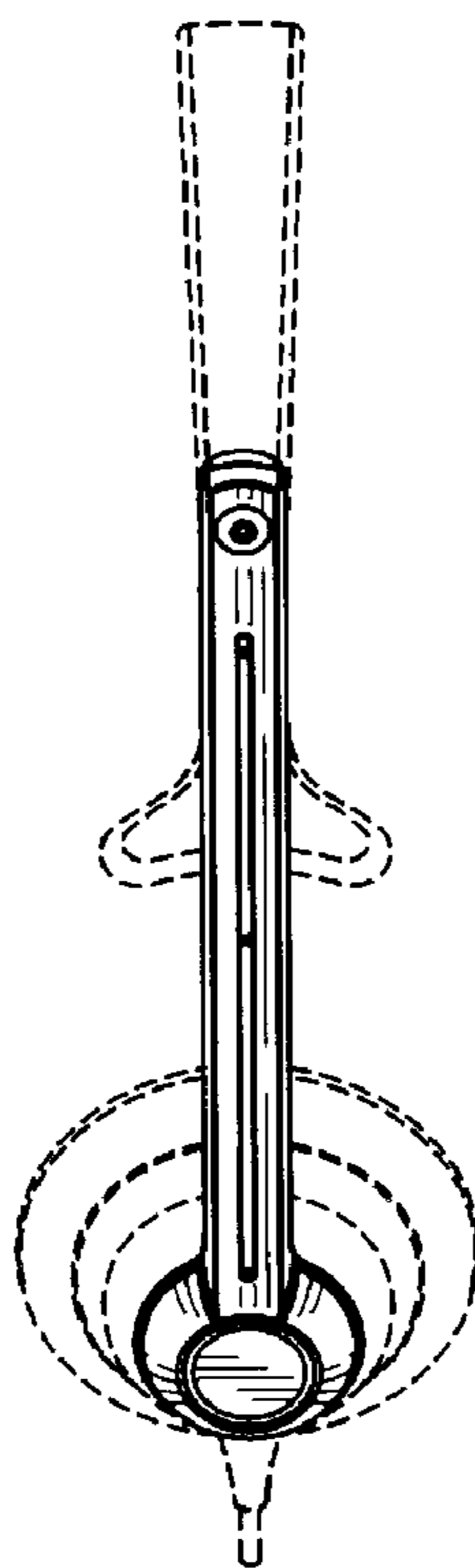

FIG. 4

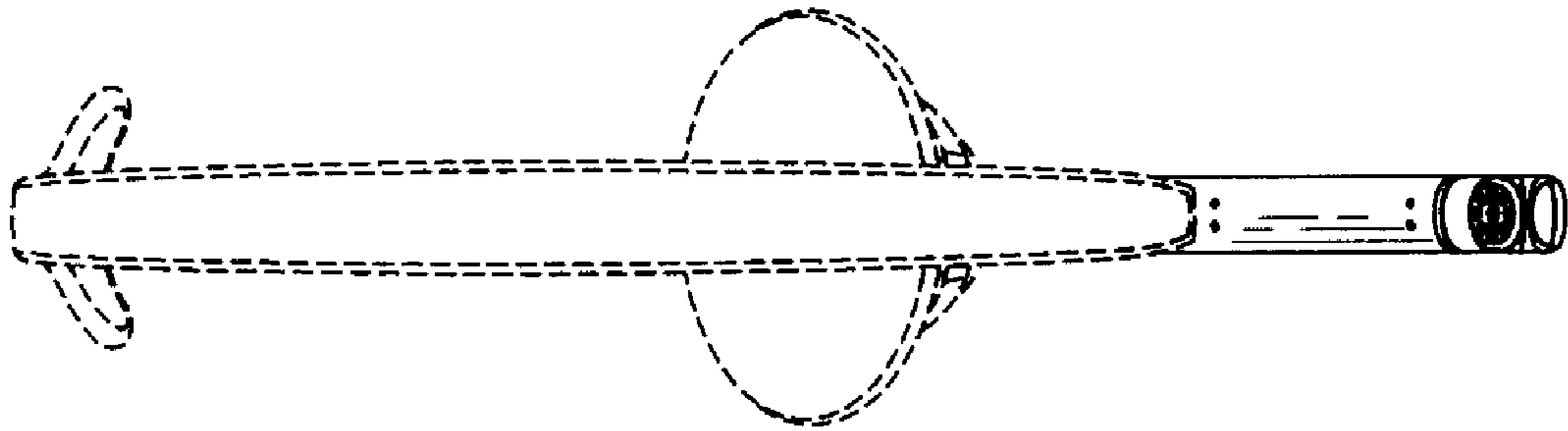

FIG. 5

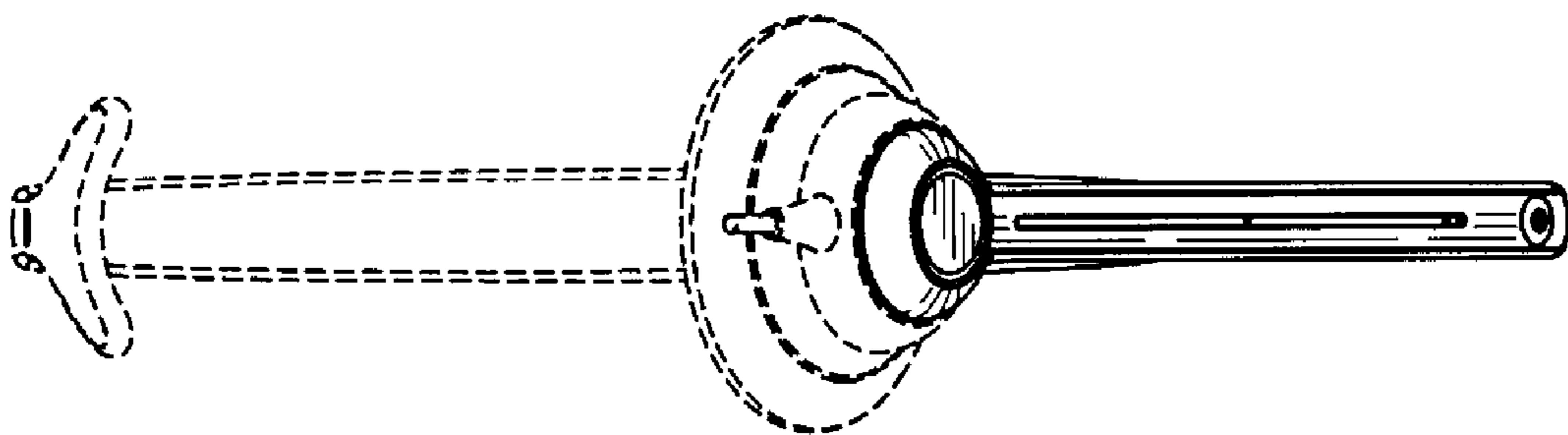

FIG. 6

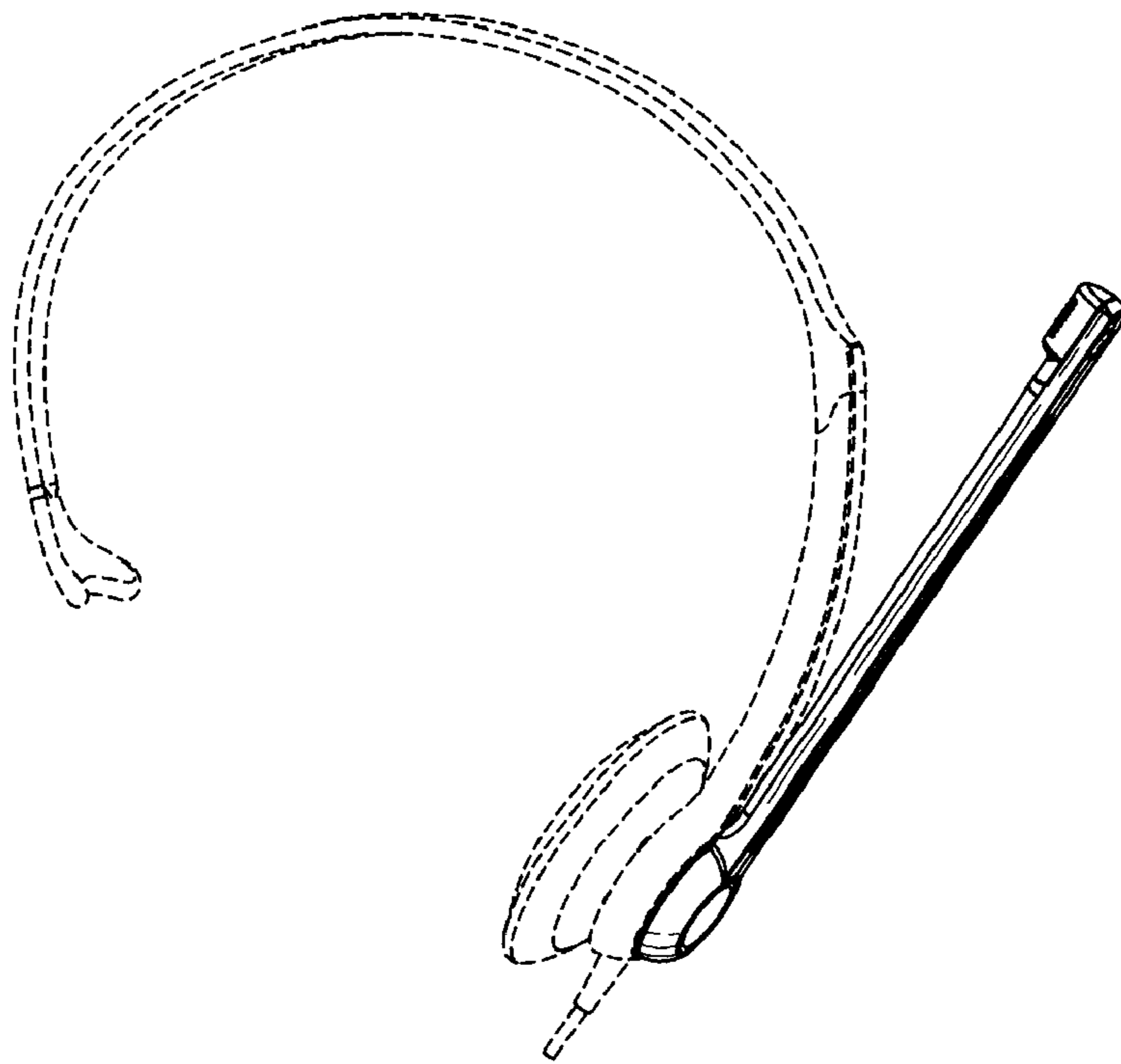

FIG. 7

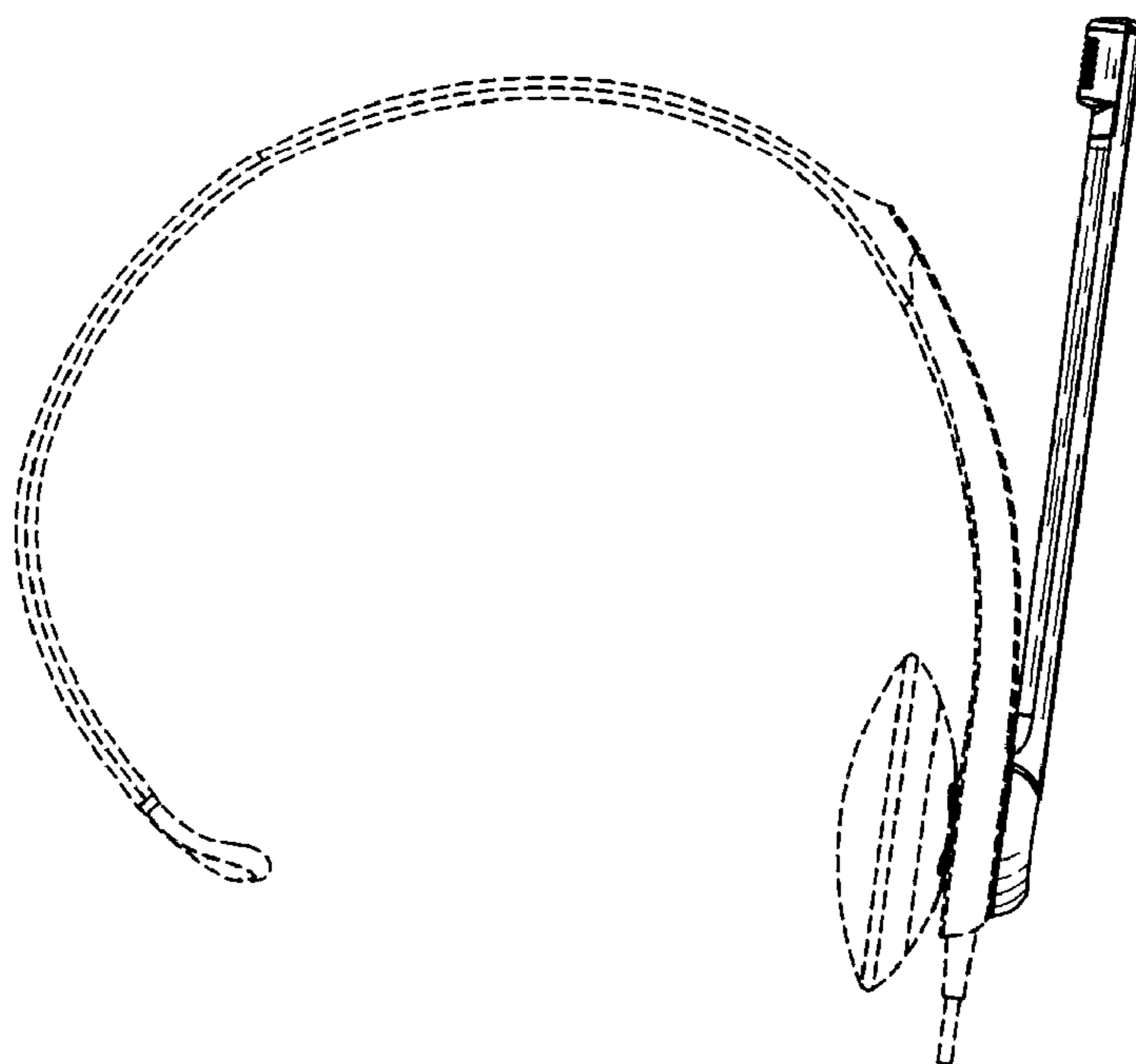

FIG. 8

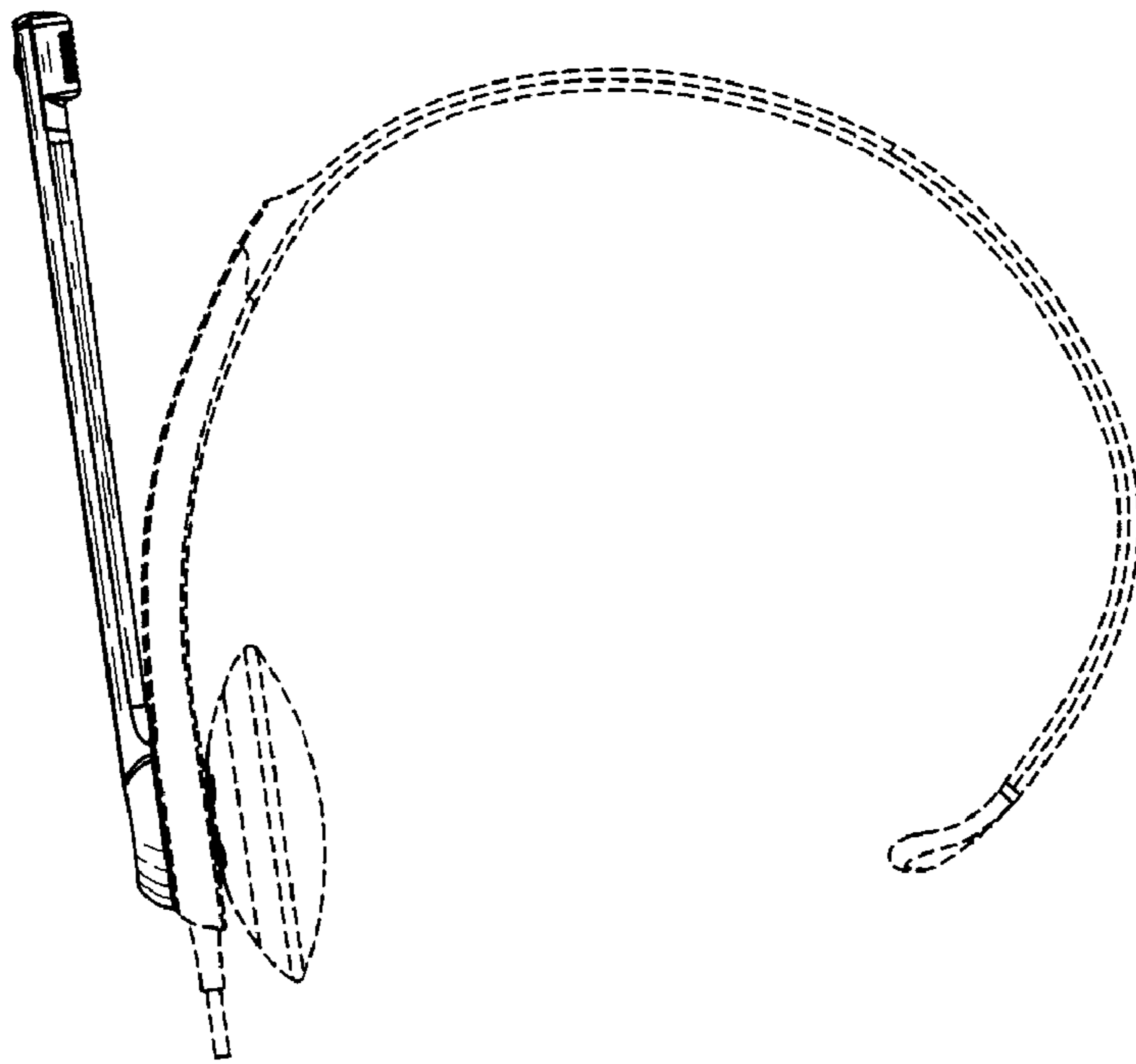

FIG. 9

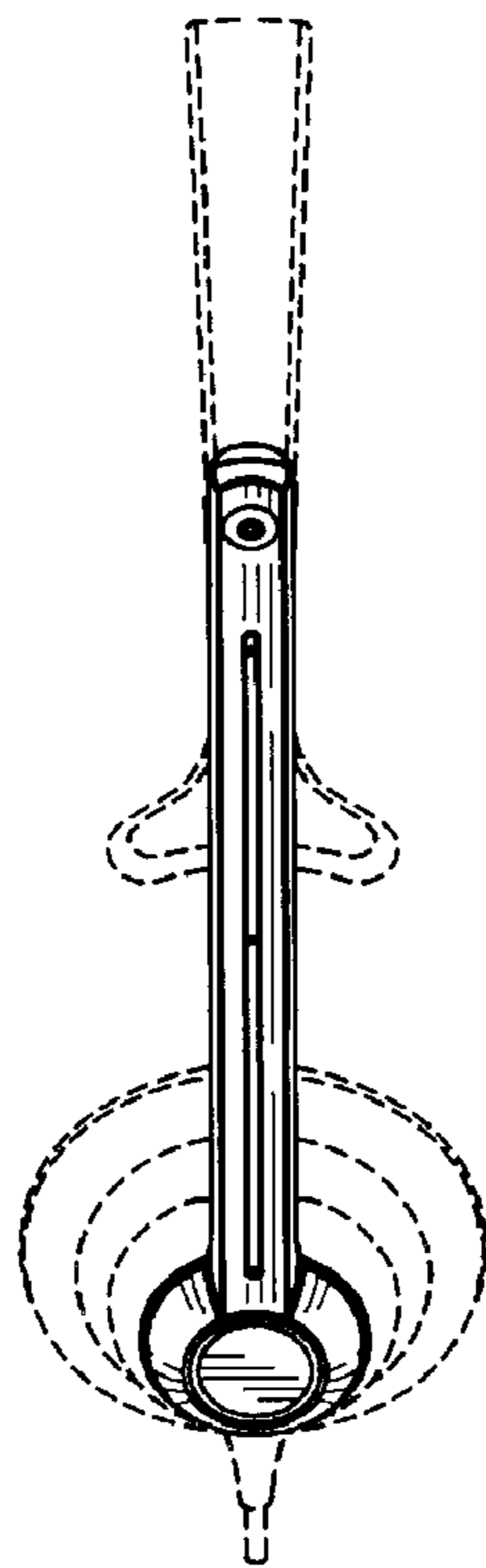

FIG. 10

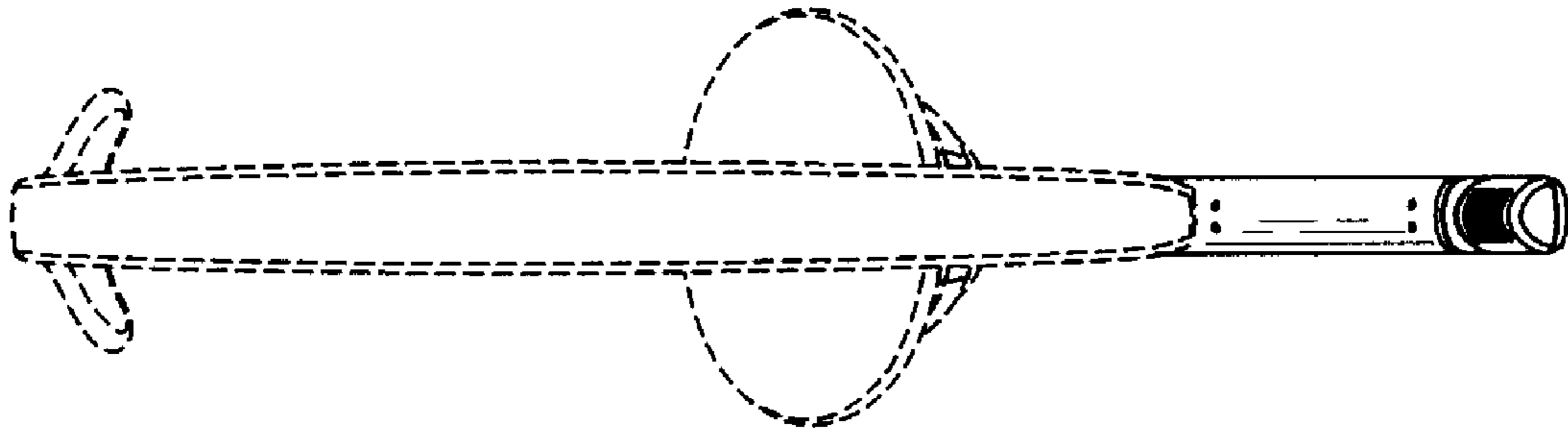

FIG. 11

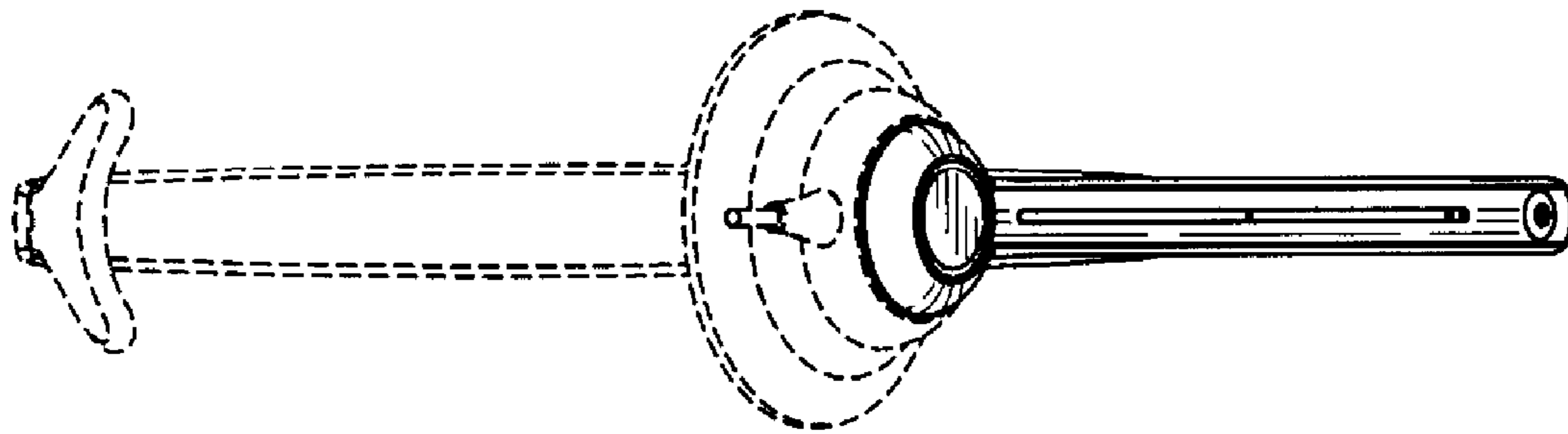

FIG. 12