



US00D518477S

(12) **United States Design Patent**  
**Chen**

(10) **Patent No.:** **US D518,477 S**

(45) **Date of Patent:** **\*\* Apr. 4, 2006**

(54) **BLUETOOTH EARPHONE WITH A CONNECTOR**

(75) Inventor: **Lu-Cheng Chen**, Taipei (TW)

(73) Assignee: **He-And Technology Co., Ltd.**, Taipei (TW)

(\*\*) Term: **14 Years**

(21) Appl. No.: **29/231,424**

(22) Filed: **Jun. 6, 2005**

(51) **LOC (8) Cl.** ..... **14-01**

(52) **U.S. Cl.** ..... **D14/223; D14/205**

(58) **Field of Classification Search** ..... D14/137,  
D14/138, 142, 147, 148, 150, 155, 191, 240,  
D14/223, 181, 188, 205, 192, 206; D13/184;  
320/111, 113, 107, 114; 379/426, 430, 431,  
379/433, 454, 455, 446; 455/573, 462; 381/374,  
381/376-379, 381

See application file for complete search history.

(56) **References Cited**

**U.S. PATENT DOCUMENTS**

D302,689 S \* 8/1989 Murakami et al. .... D14/138  
5,230,016 A \* 7/1993 Yasuda ..... 455/573  
D364,618 S \* 11/1995 Somoza ..... D14/142  
D368,713 S \* 4/1996 Tomlinson et al. .... D14/150

D391,953 S \* 3/1998 Copeland et al. .... D14/137  
6,043,626 A \* 3/2000 Snyder et al. .... 320/113  
6,229,893 B1 \* 5/2001 Chen ..... 379/454  
6,307,348 B1 \* 10/2001 Green ..... 320/111  
D464,038 S \* 10/2002 Bebenroth ..... D14/223  
D471,898 S \* 3/2003 Bae ..... D14/223  
D494,568 S \* 8/2004 Pan ..... D14/223

\* cited by examiner

*Primary Examiner*—Paula A. Greene

(74) *Attorney, Agent, or Firm*—Rosenberg, Klein & Lee

(57) **CLAIM**

The ornamental design for a bluetooth earphone with a connector, as shown and described.

**DESCRIPTION**

FIG. 1 is a perspective view of a bluetooth earphone with a connector, showing my new design;  
FIG. 2 is a front view thereof;  
FIG. 3 is a rear view thereof;  
FIG. 4 is a left side view thereof;  
FIG. 5 is a right side view thereof;  
FIG. 6 is a top view thereof;  
FIG. 7 is a bottom view thereof; and,  
FIG. 8 is an exploded view of a bluetooth earphone and a connector thereof.

**1 Claim, 5 Drawing Sheets**

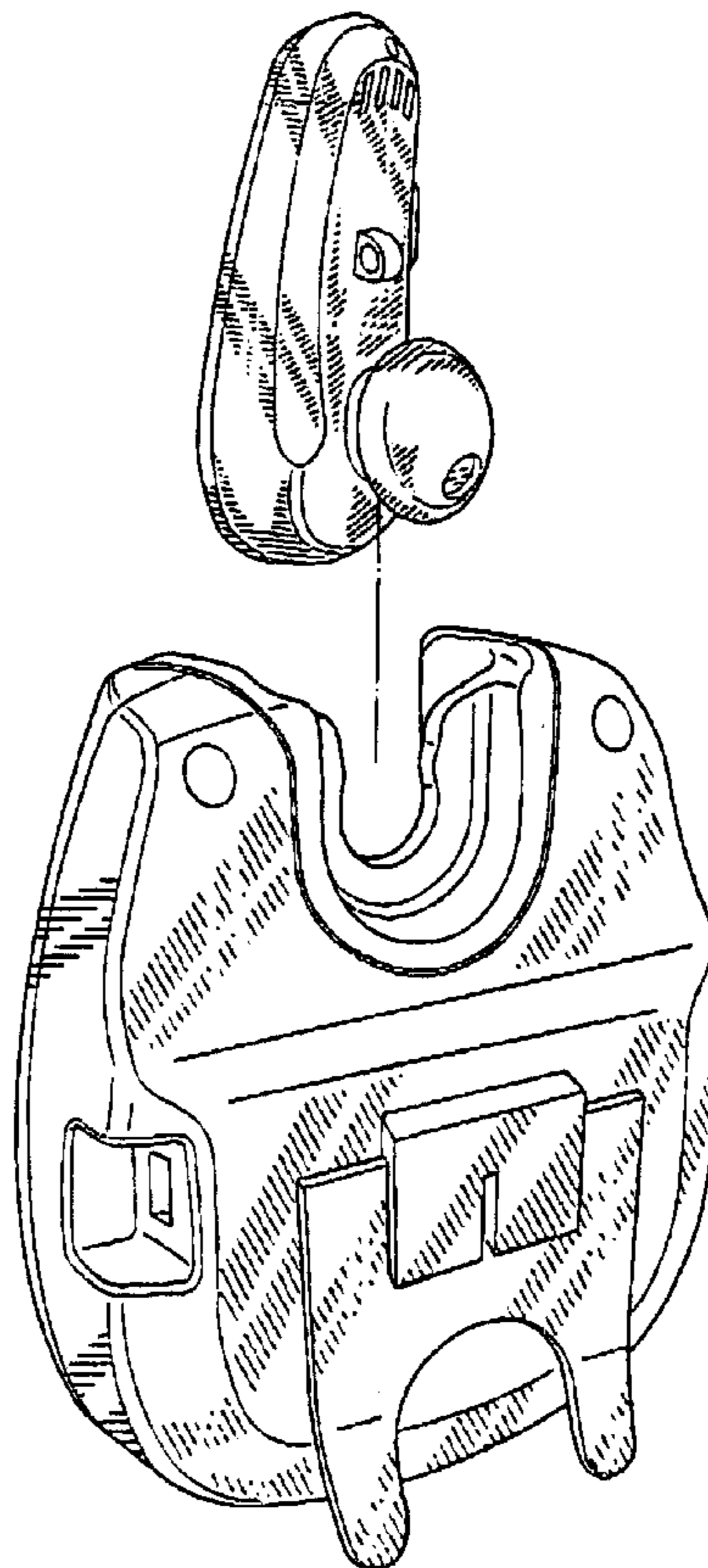
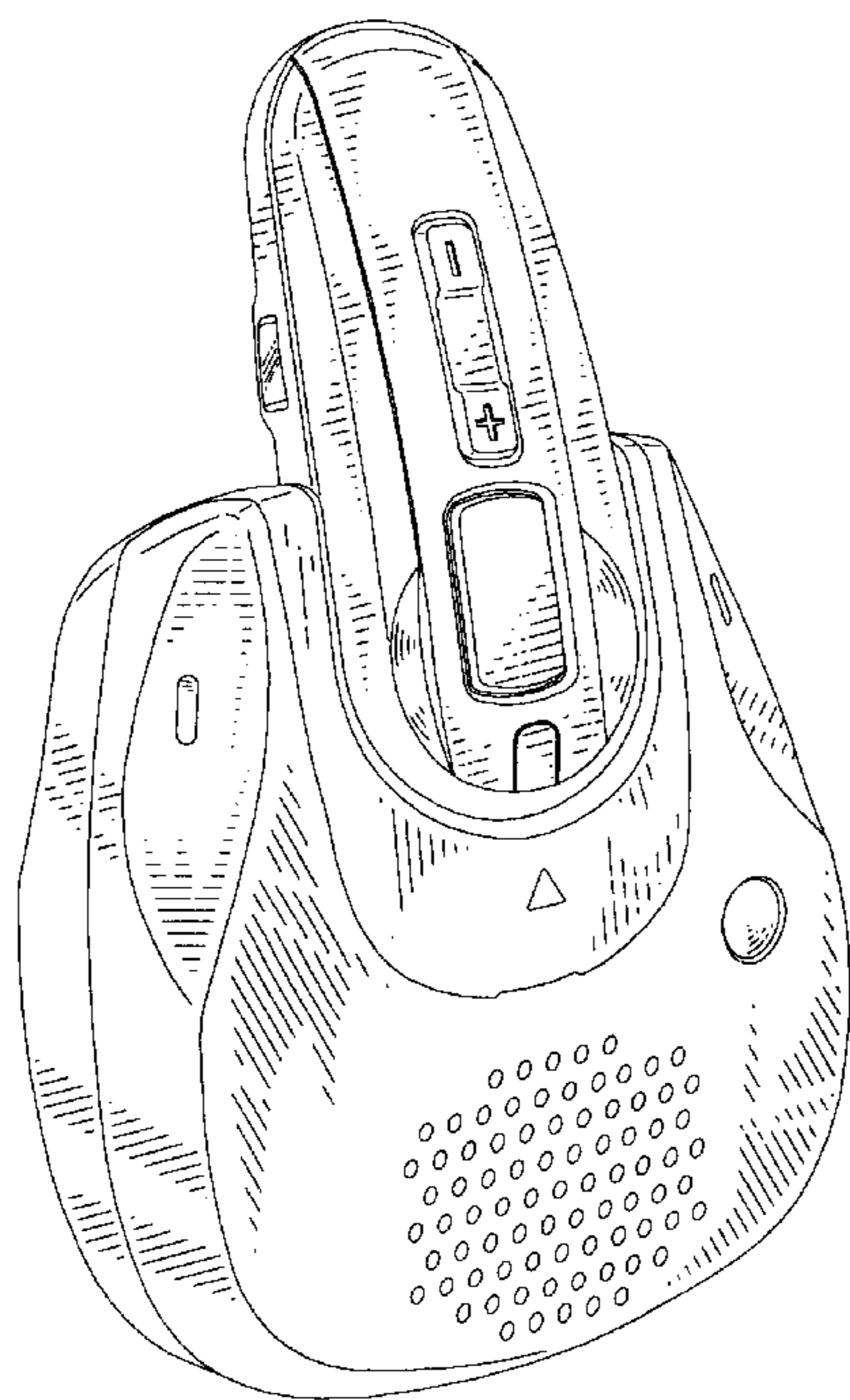

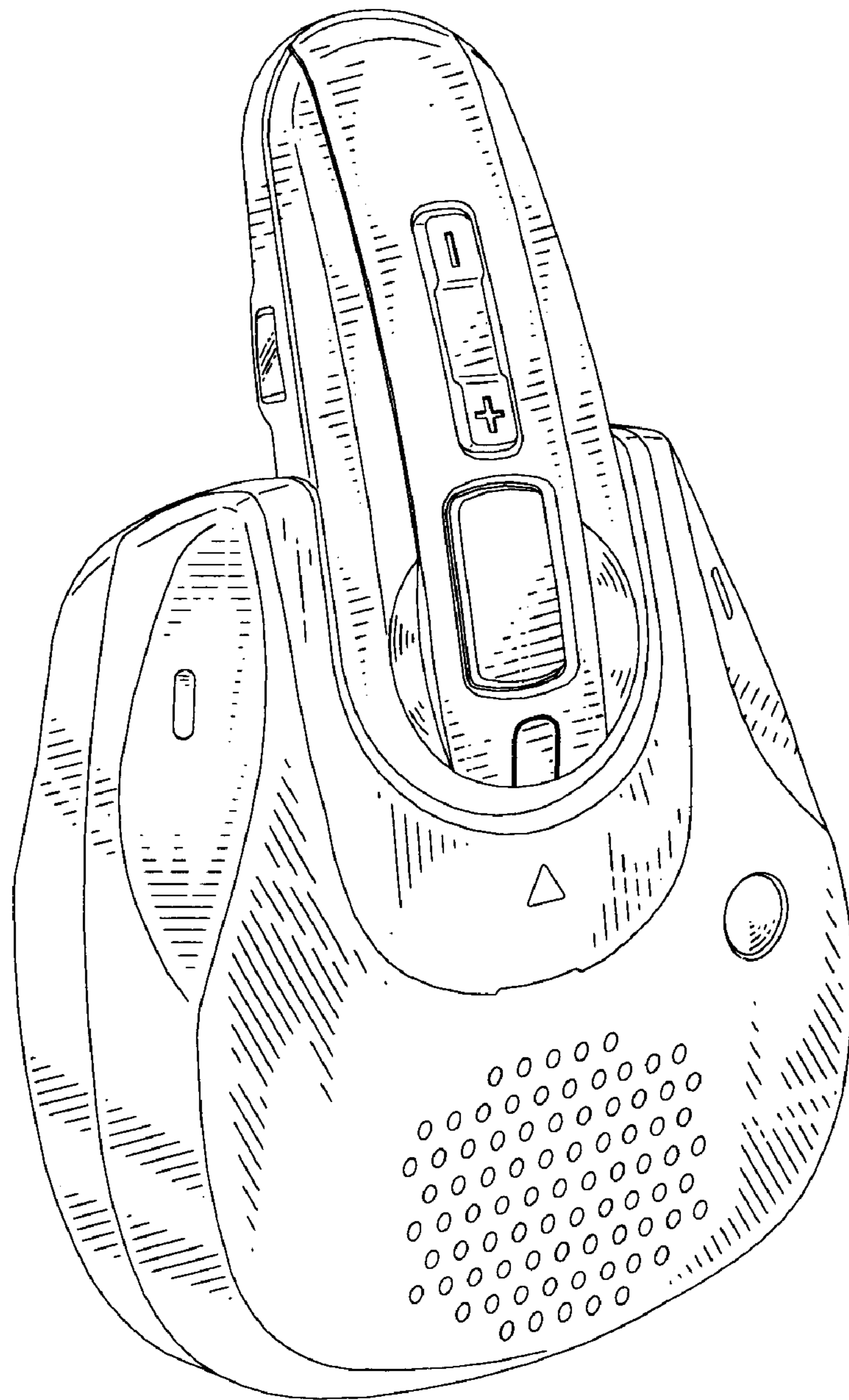

FIG 1

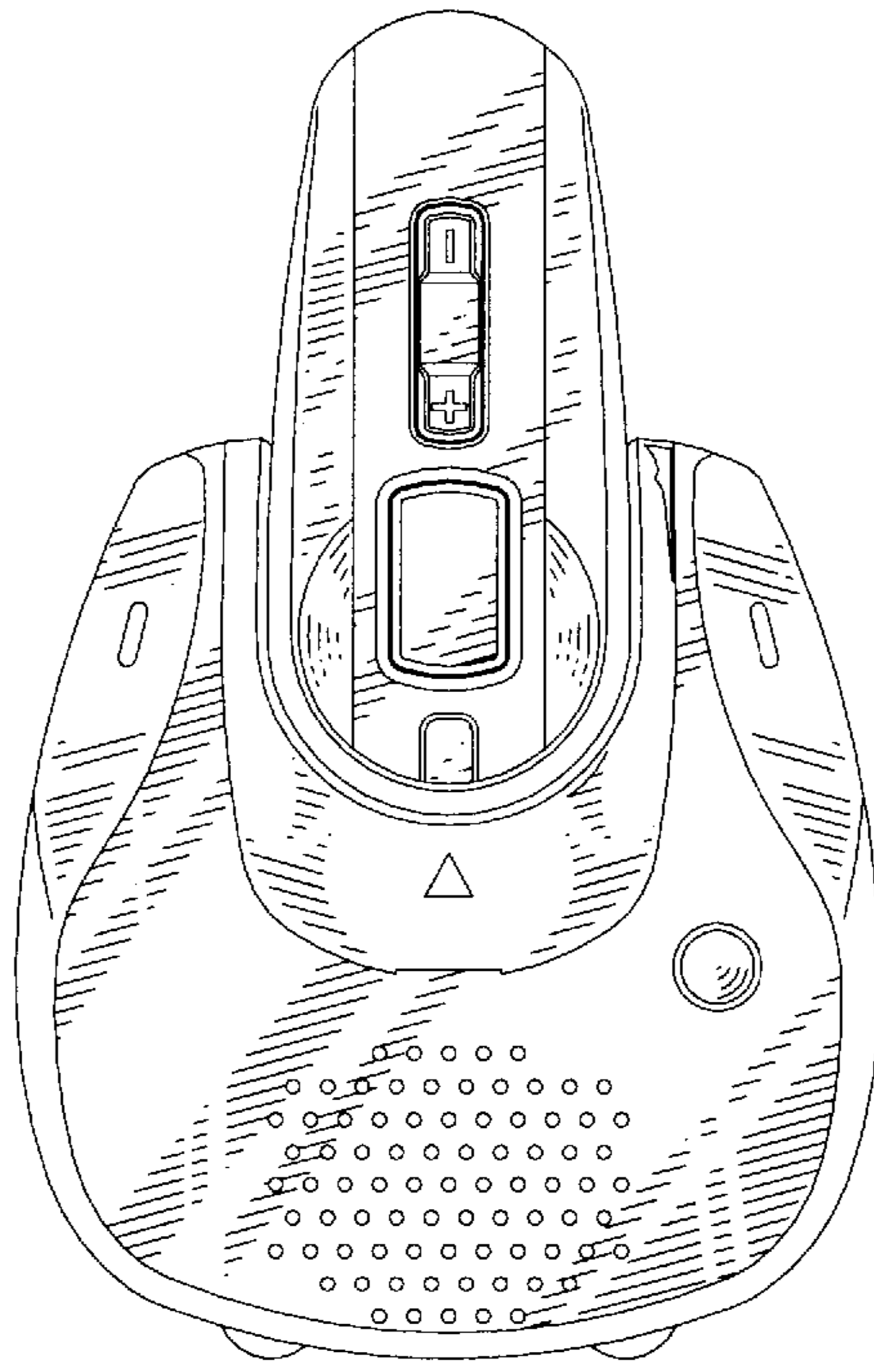

FIG 2

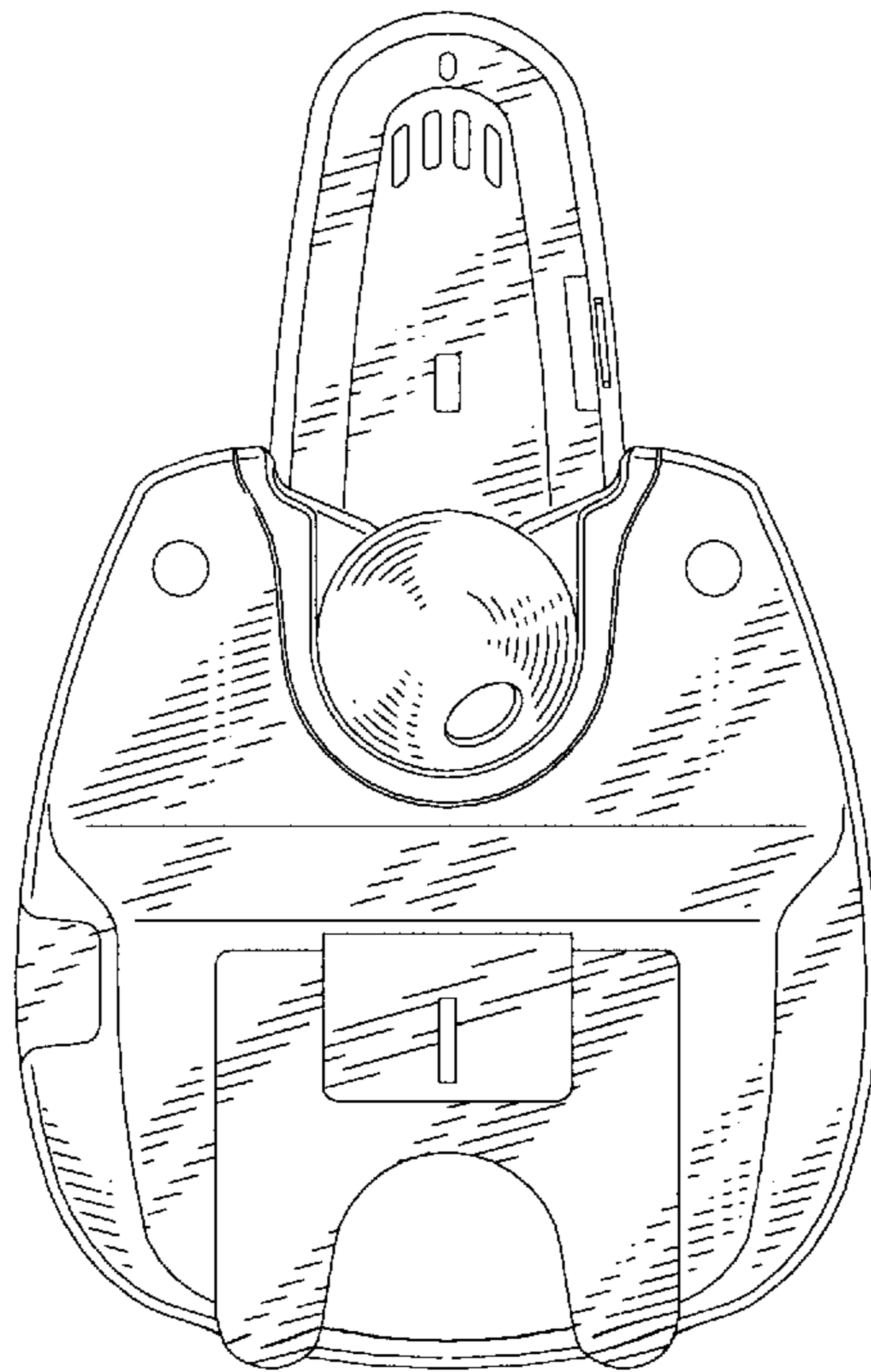

FIG 3

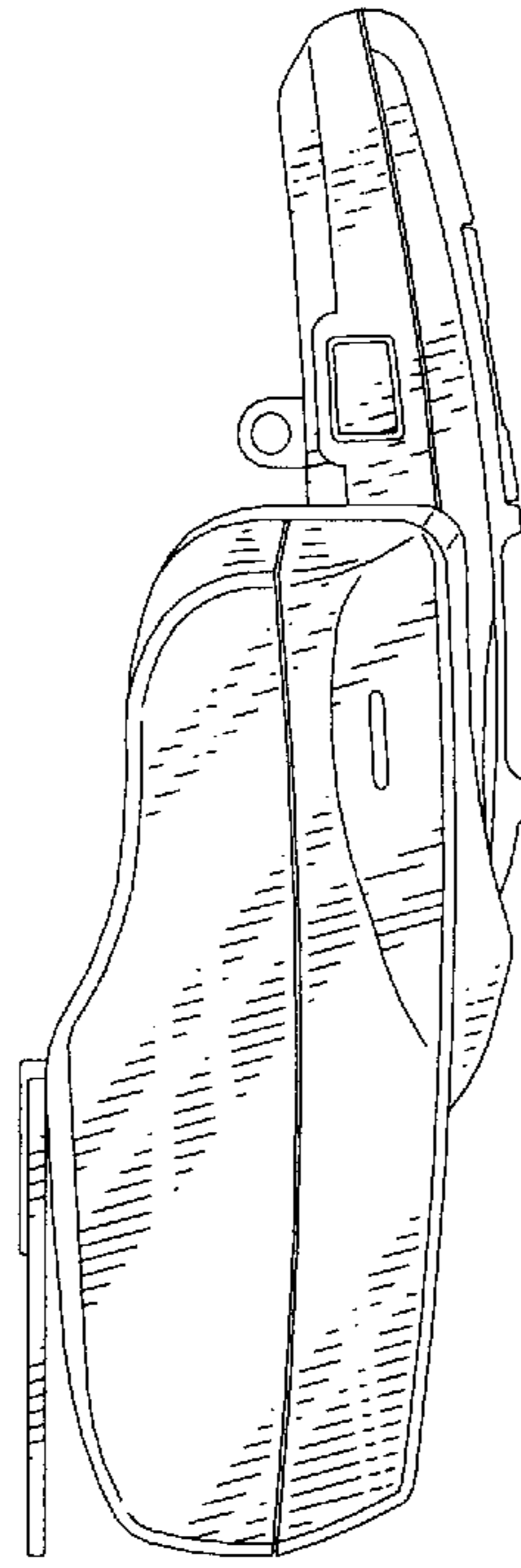

FIG 4

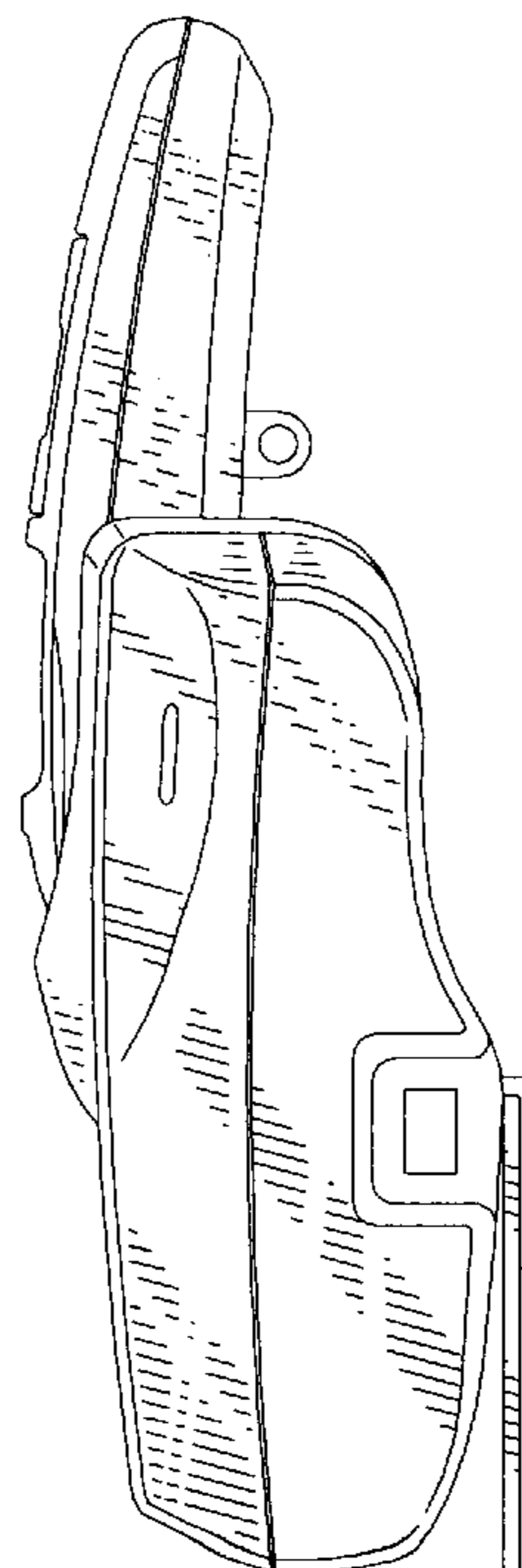

FIG 5

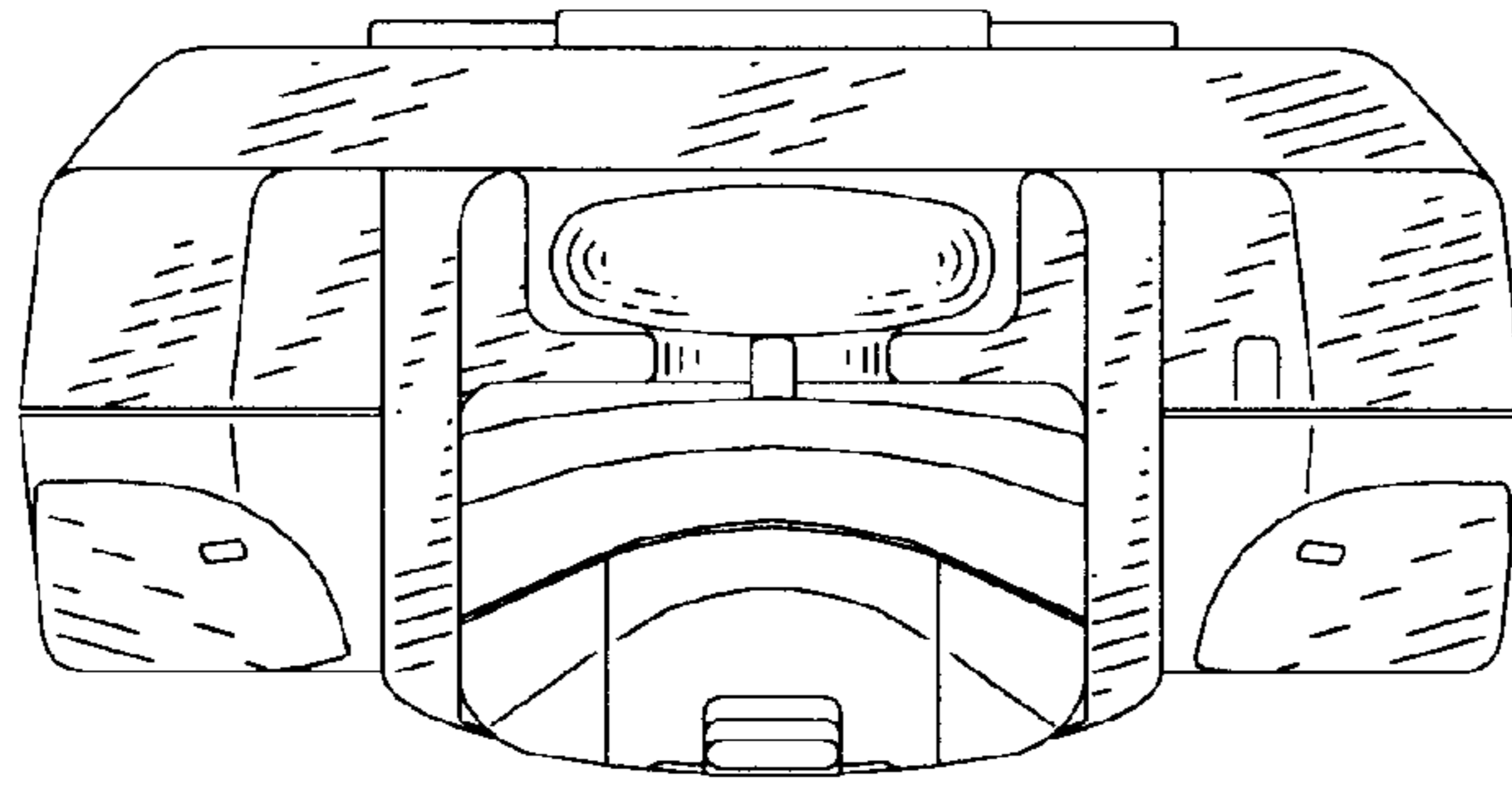

FIG 6

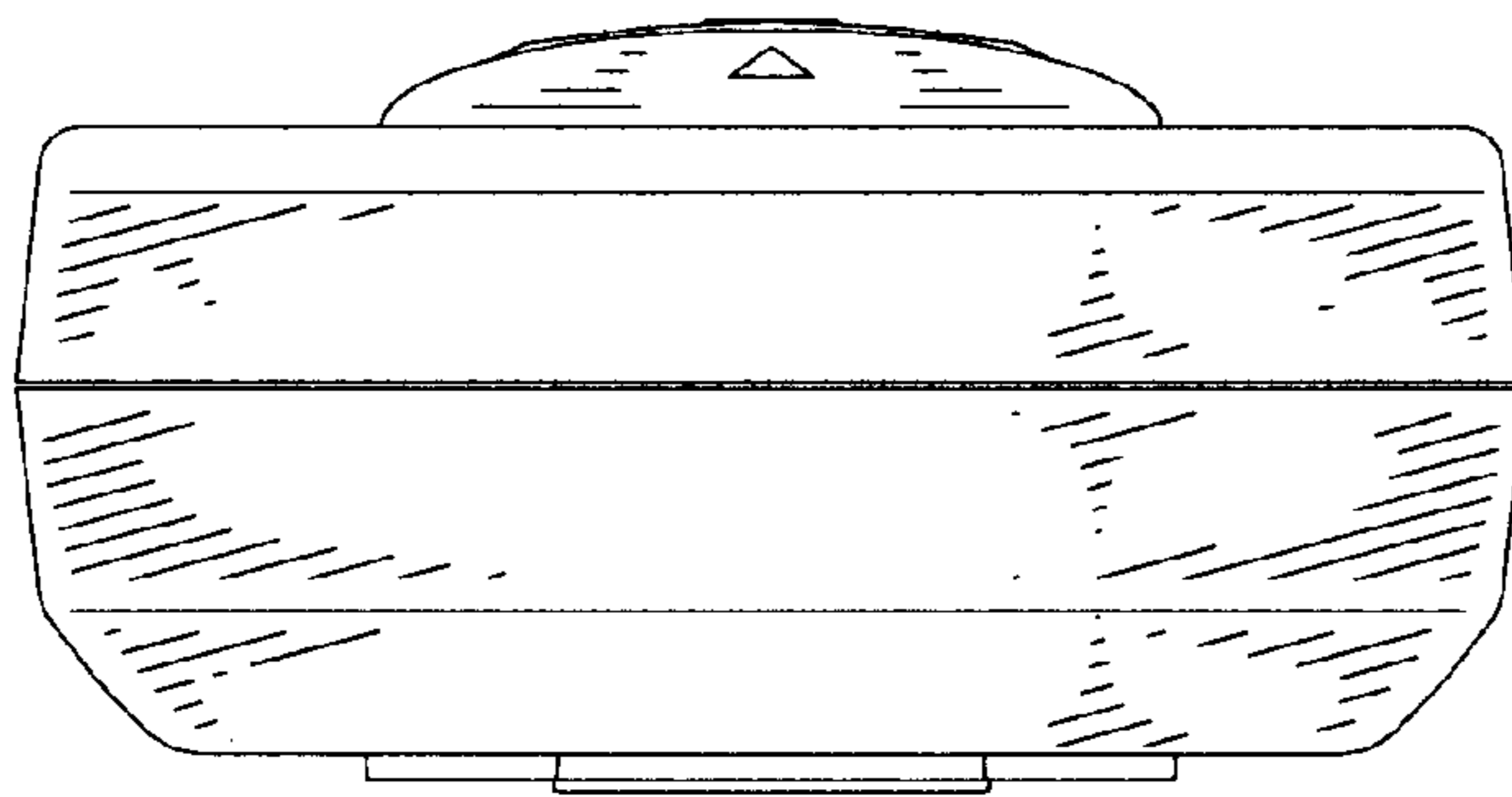

FIG 7

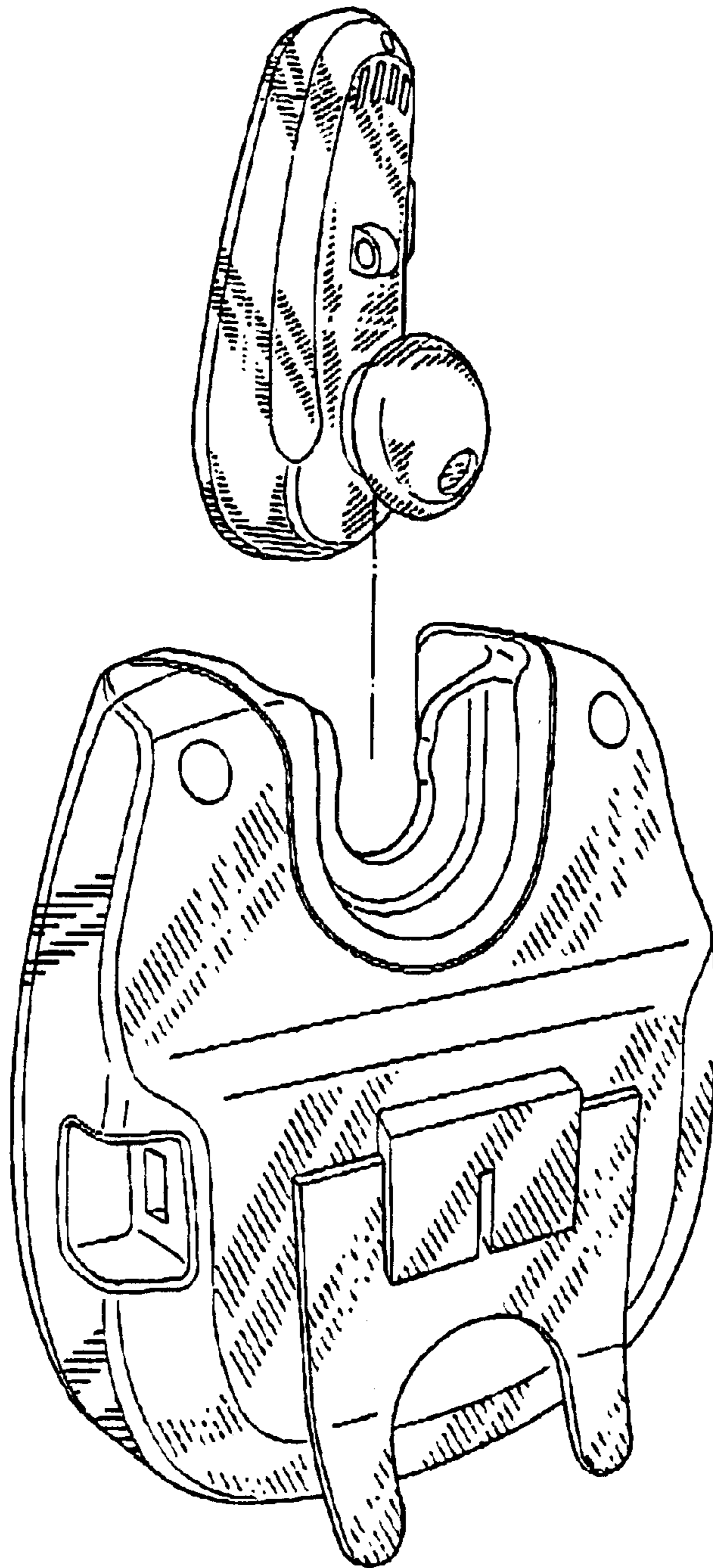

FIG. 8