



US00D518448S

(12) **United States Design Patent**
Sorenson

(10) **Patent No.:** **US D518,448 S**

(45) **Date of Patent:** **** Apr. 4, 2006**

(54) **ELECTRICAL ROCKER SWITCH
ACTUATOR**

(75) Inventor: **Richard Sorenson**, Stuart, FL (US)

(73) Assignee: **Carling Technologies, Inc.**, Plainville,
CT (US)

(**) Term: **14 Years**

(21) Appl. No.: **29/218,759**

(22) Filed: **Dec. 7, 2004**

(51) **LOC (8) Cl.** **13-03**

(52) **U.S. Cl.** **D13/174**

(58) **Field of Classification Search** D13/169,
D13/171, 170, 174; 174/57, 66; 200/6 R,
200/437, 457, 525, 553, 218, 277.2, 296,
200/297, 295, 302.3, 303, 310, 315, 329,
200/330, 331, 332.1, 333, 335; 307/141,
307/157

See application file for complete search history.

(56) **References Cited**

U.S. PATENT DOCUMENTS

D328,454 S	*	8/1992	Sorenson et al.	D13/174
D341,568 S	*	11/1993	Sorenson et al.	D13/174
D403,306 S	*	12/1998	LeClair et al.	D13/169
D454,120 S	*	3/2002	Sadowski et al.	D13/174
D458,231 S	*	6/2002	Errato	D13/169

* cited by examiner

Primary Examiner—Stella Reid

Assistant Examiner—Selina Sikder

(74) *Attorney, Agent, or Firm*—McCormick, Paulding &
Huber LLP

(57) **CLAIM**

The ornamental design for an electrical rocker switch actuator, as shown and described.

DESCRIPTION

FIG. 1 is a top plan view of a first embodiment of an electrical rocker switch showing my new design;

FIG. 2 is a left side elevation view thereof;

FIG. 3 is a right side elevation view thereof;

FIG. 4 is an end elevation view thereof, the opposite end being a mirror image;

FIG. 5 is another top plan view thereof showing an alternate environment;

FIG. 6 is a left side elevation view thereof;

FIG. 7 is a right side elevation view thereof;

FIG. 8 is an end elevation view thereof, the opposite end being a mirror image;

FIG. 9 is another top plan view thereof showing an alternate environment;

FIG. 10 is a left side elevation view thereof;

FIG. 11 is a right side elevation view thereof;

FIG. 12 is an end elevation view thereof, the opposite end being a mirror image;

FIG. 13 is a top plan view of a second embodiment thereof;

FIG. 14 is a left side elevation view thereof, the right side being a mirror image;

FIG. 15 is an end elevation view thereof;

FIG. 16 is an opposite end elevation view thereof;

FIG. 17 is a top plan view of a third embodiment thereof;

FIG. 18 is a left side elevation view thereof, the right side being a mirror image;

FIG. 19 is an end elevation view thereof; and,

FIG. 20 is an opposite end elevation view thereof.

The broken line showing of the environment is for illustrative purpose only and forms no part of the claimed design.

1 Claim, 5 Drawing Sheets

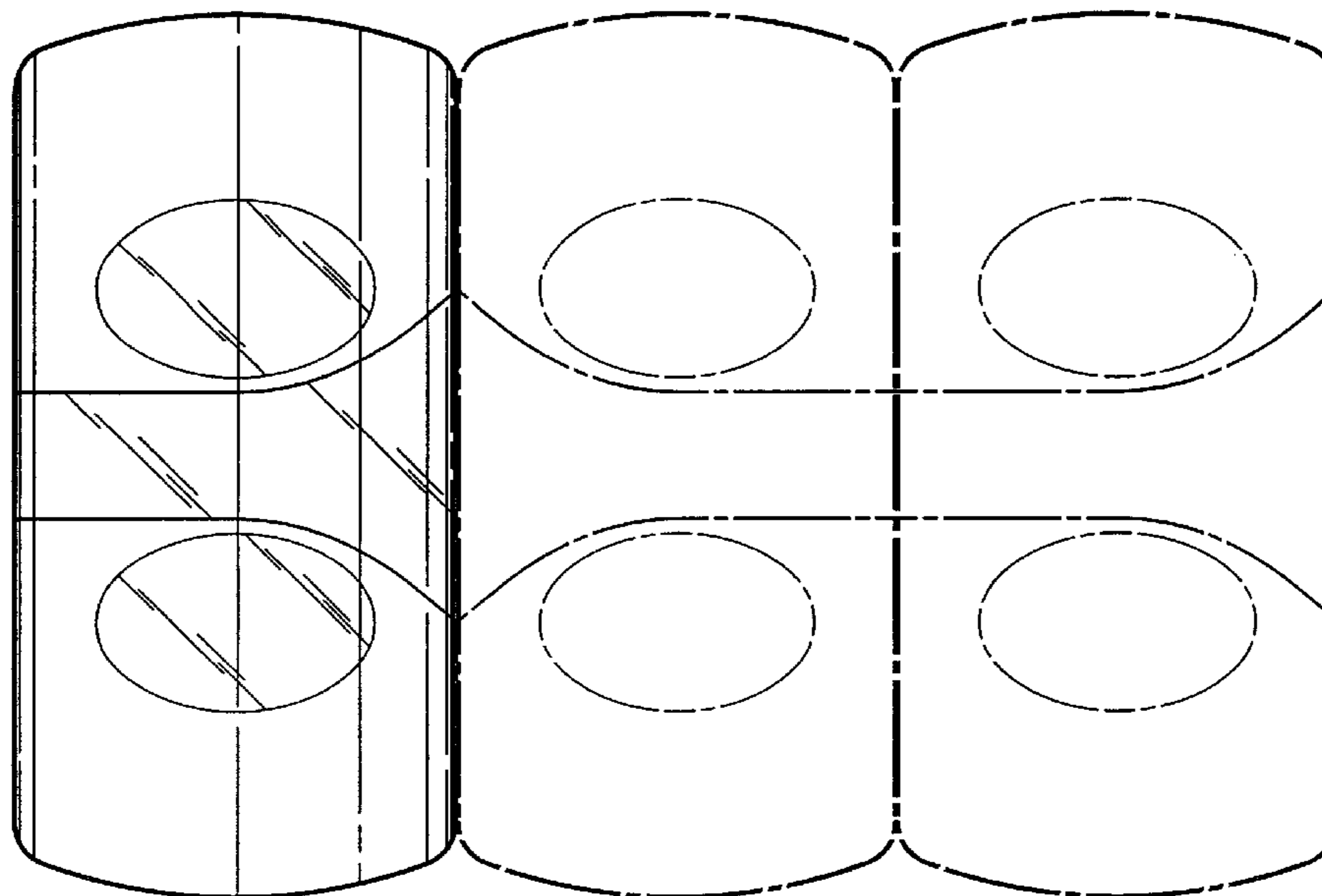

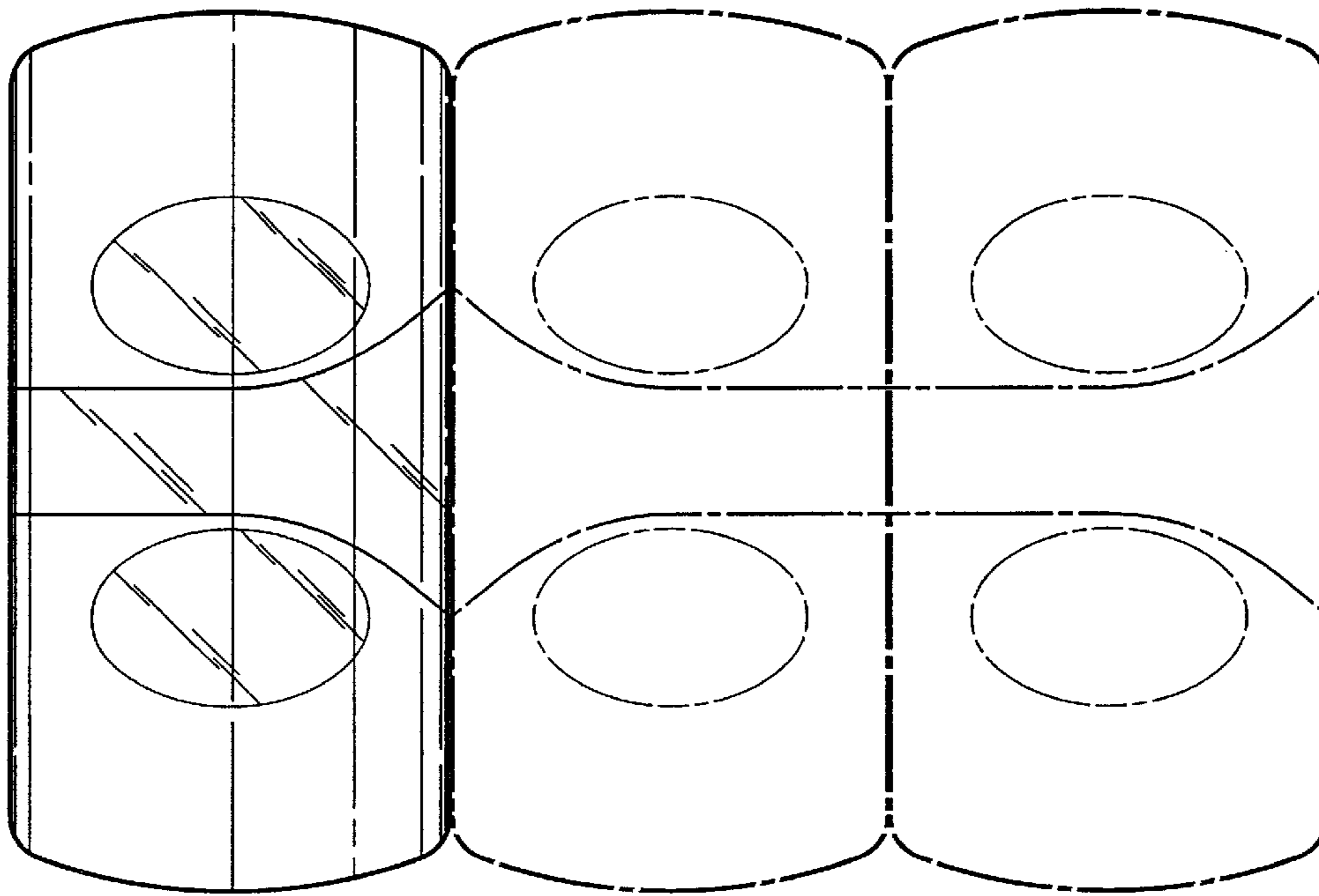

FIG. 1

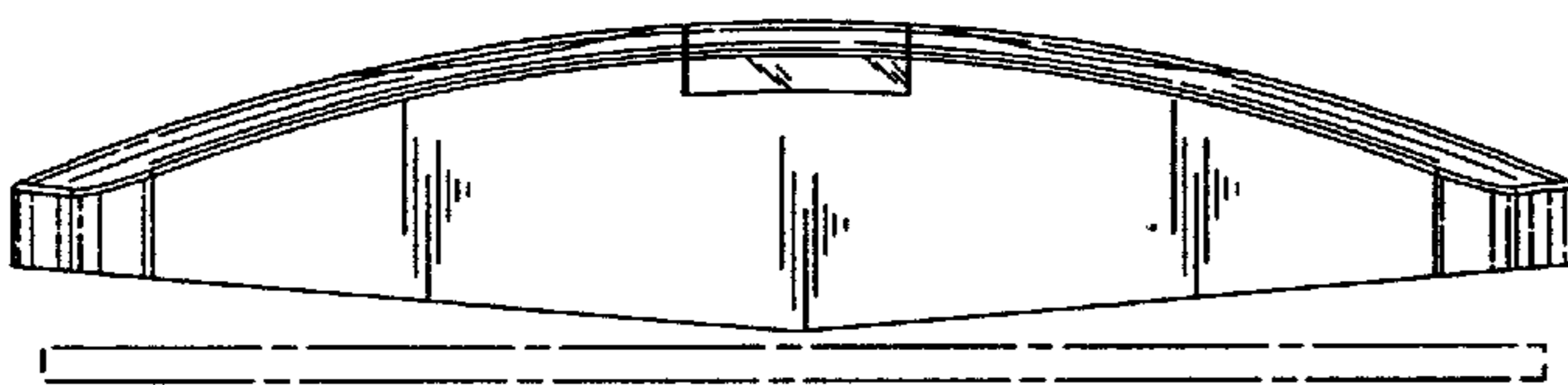

FIG. 2

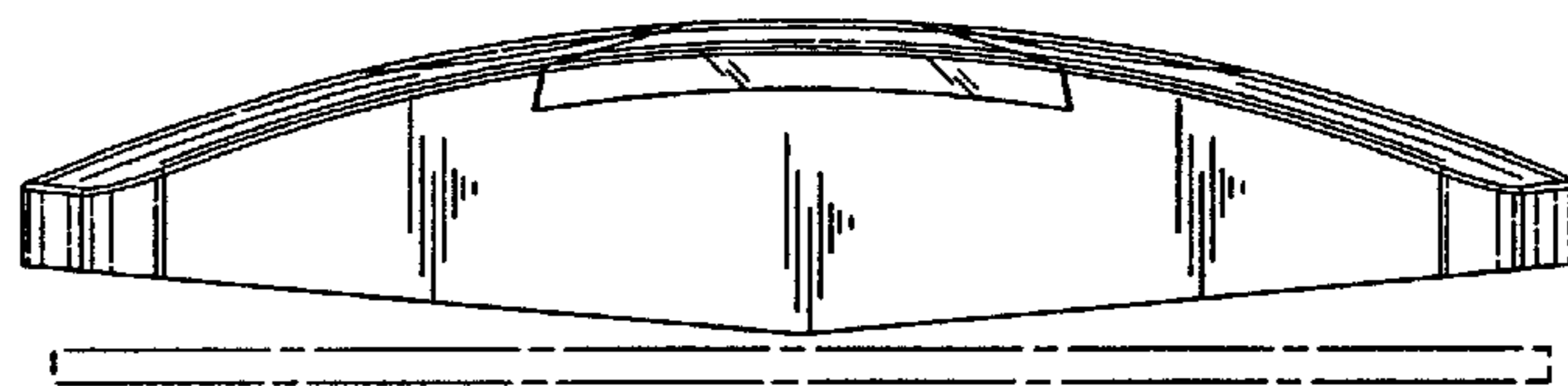

FIG. 3

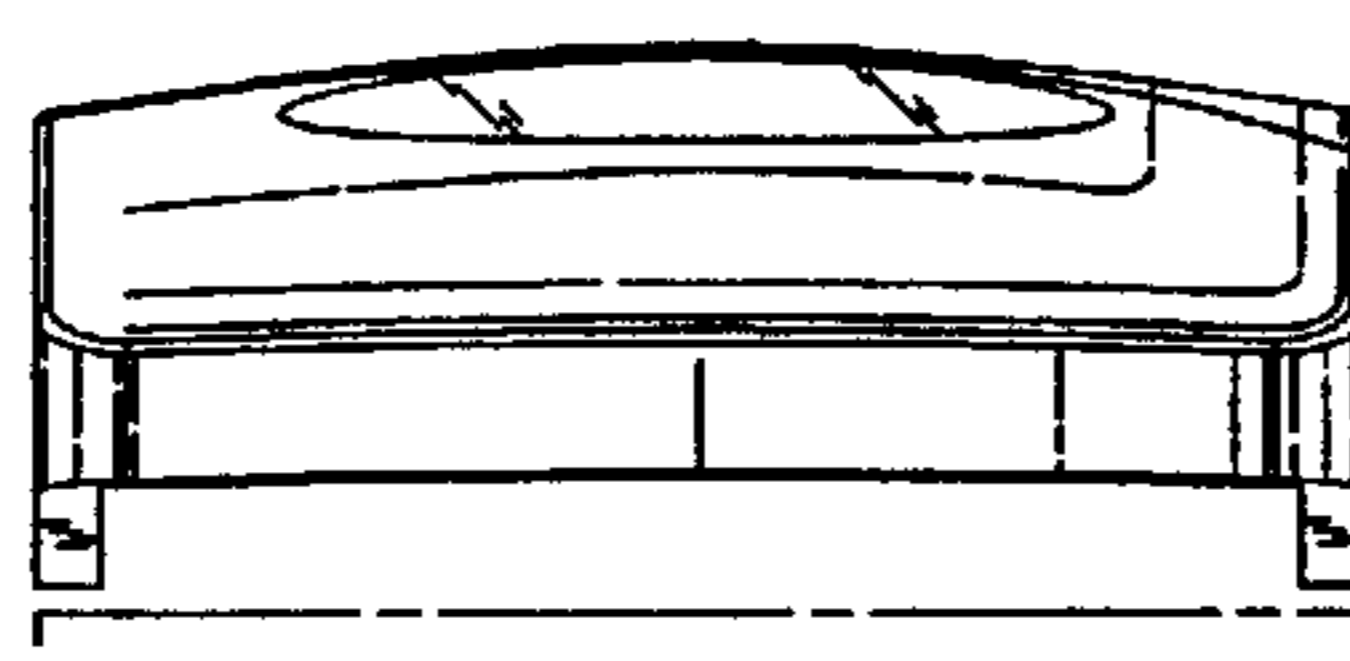

FIG. 4

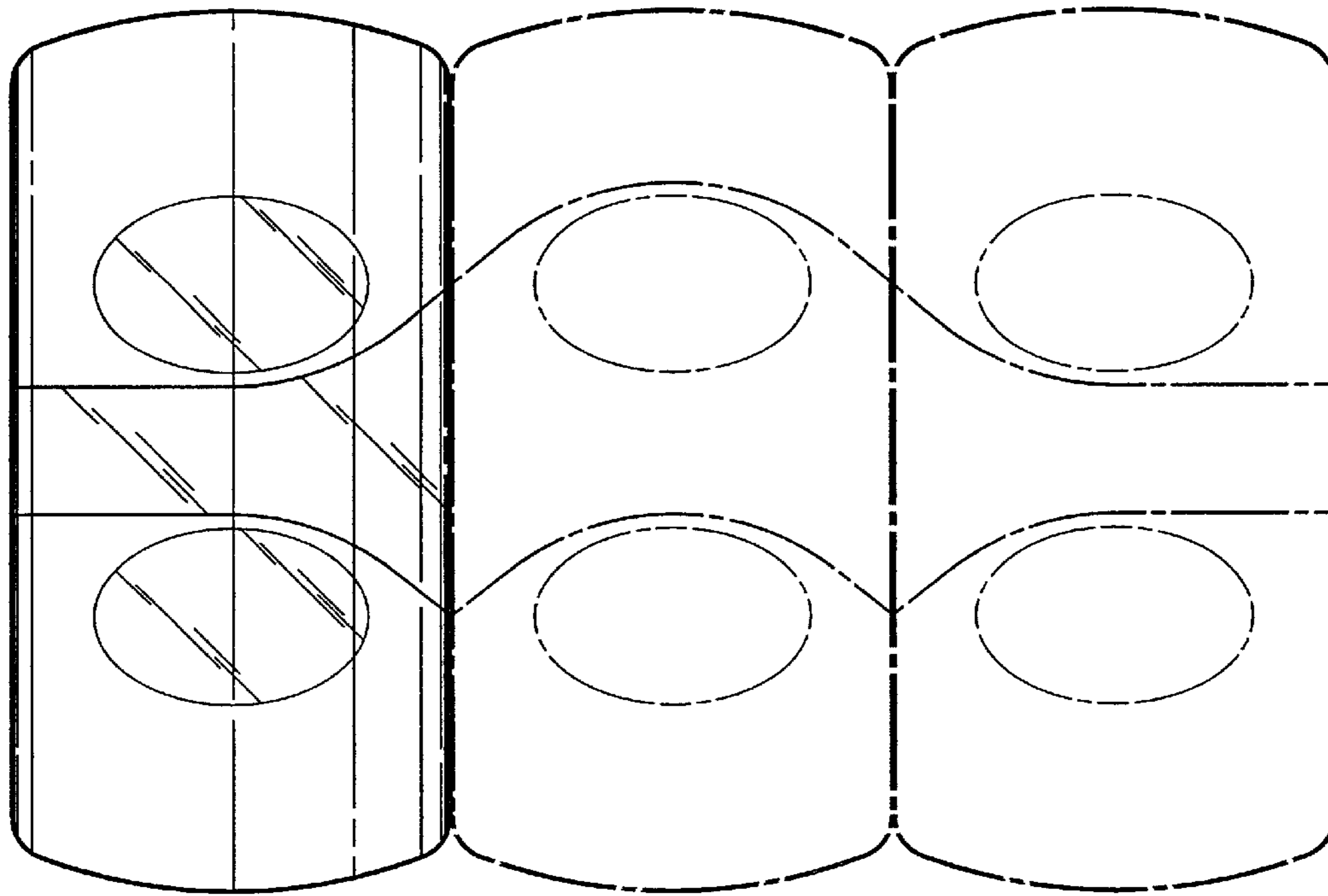

FIG. 5

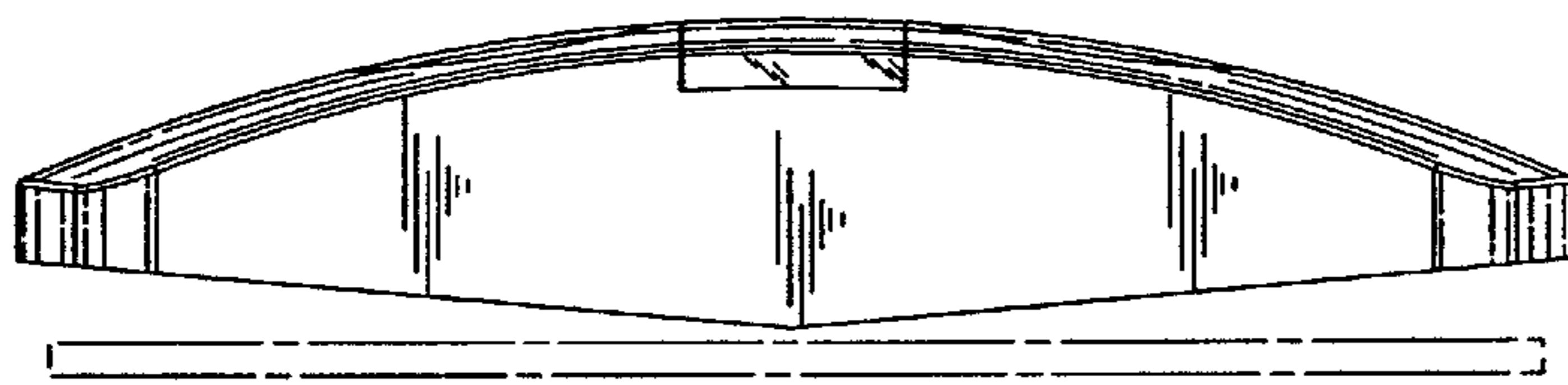

FIG. 6

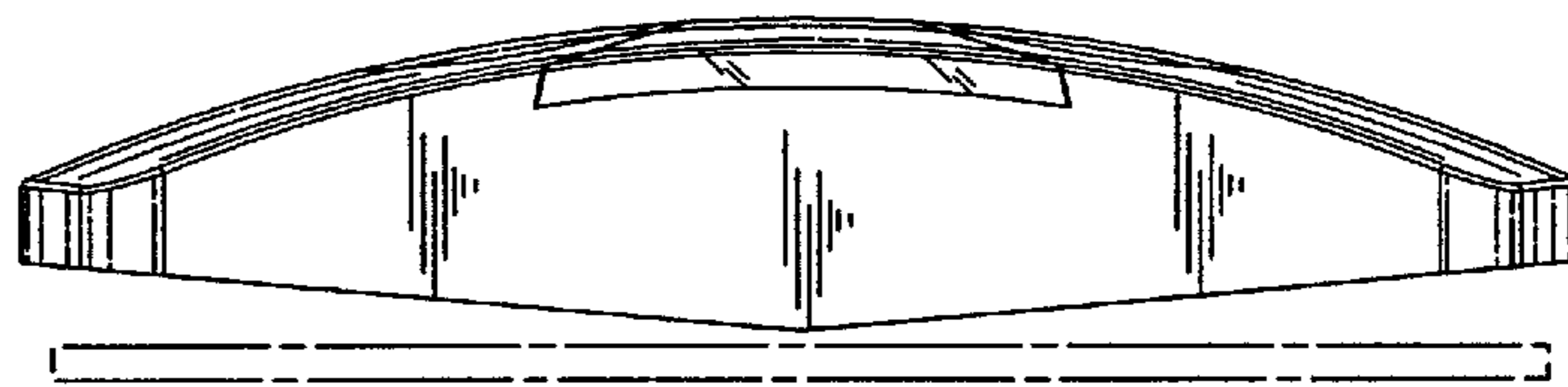

FIG. 7

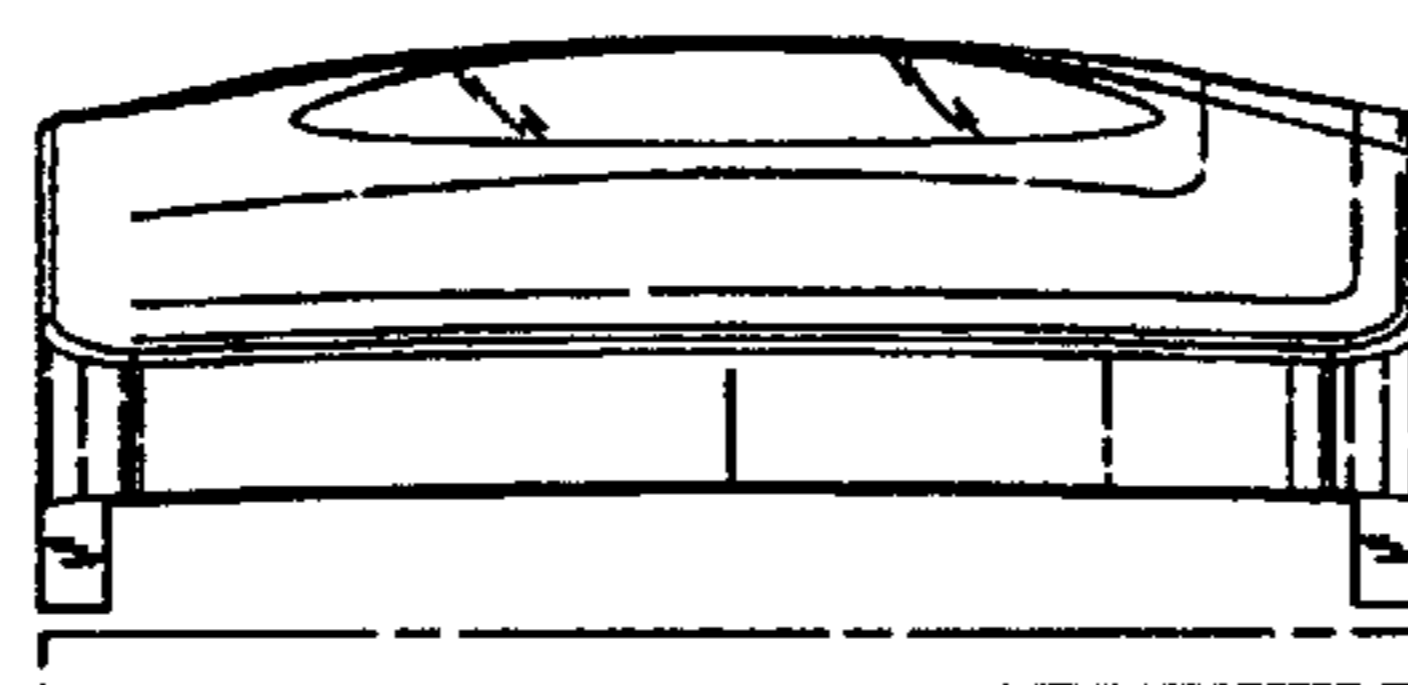

FIG. 8

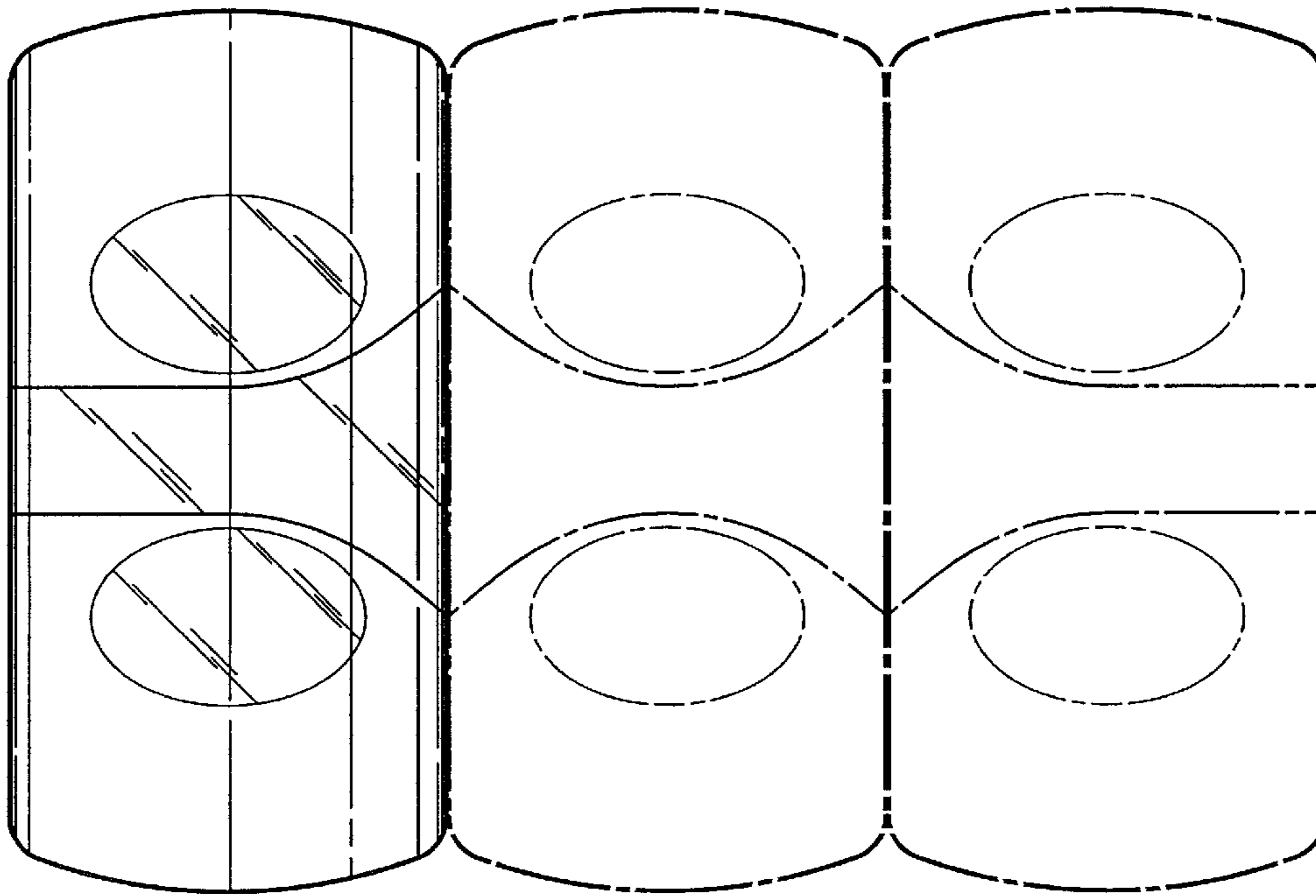

FIG. 9

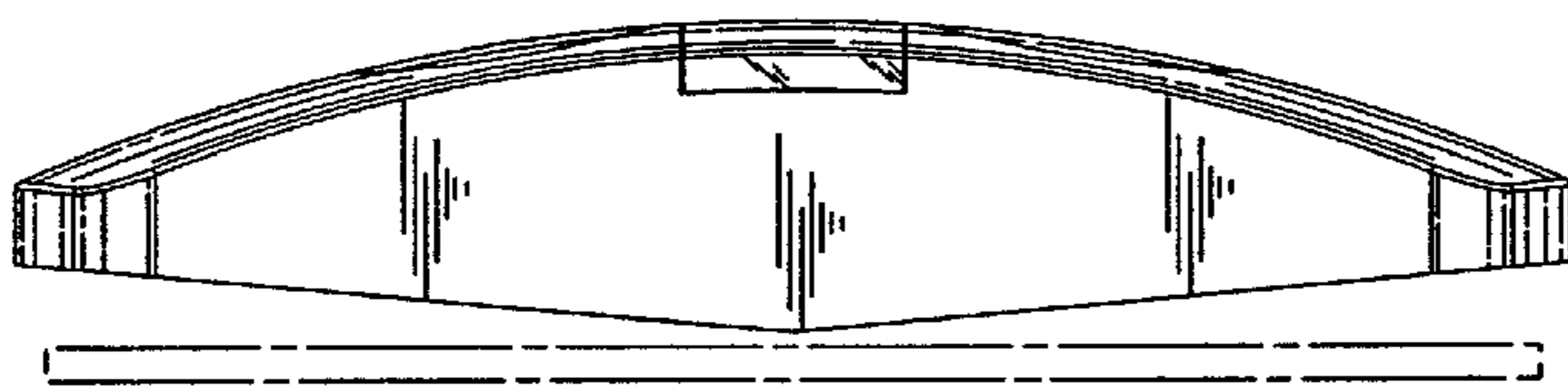

FIG. 10

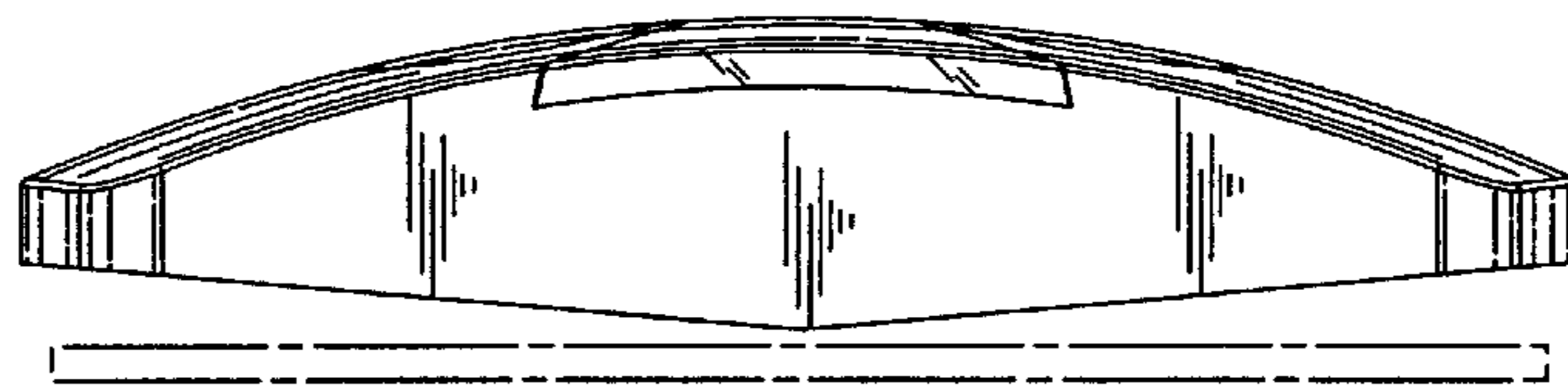

FIG. 11

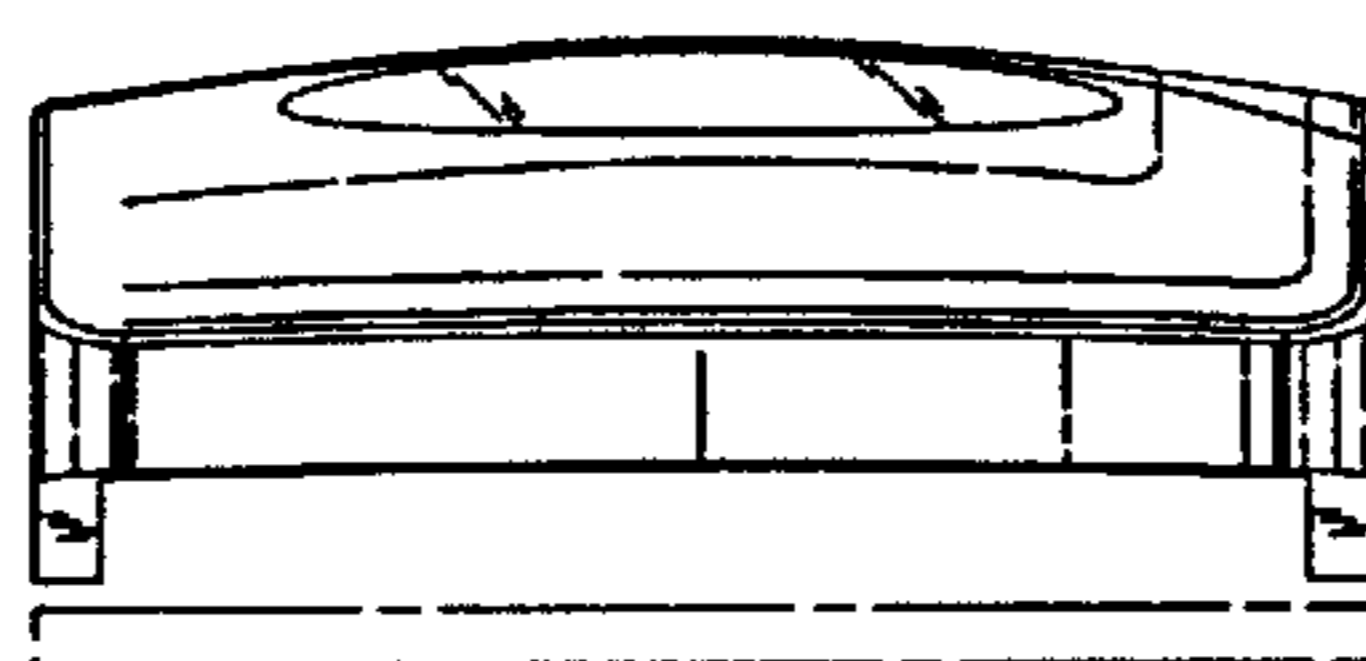

FIG. 12

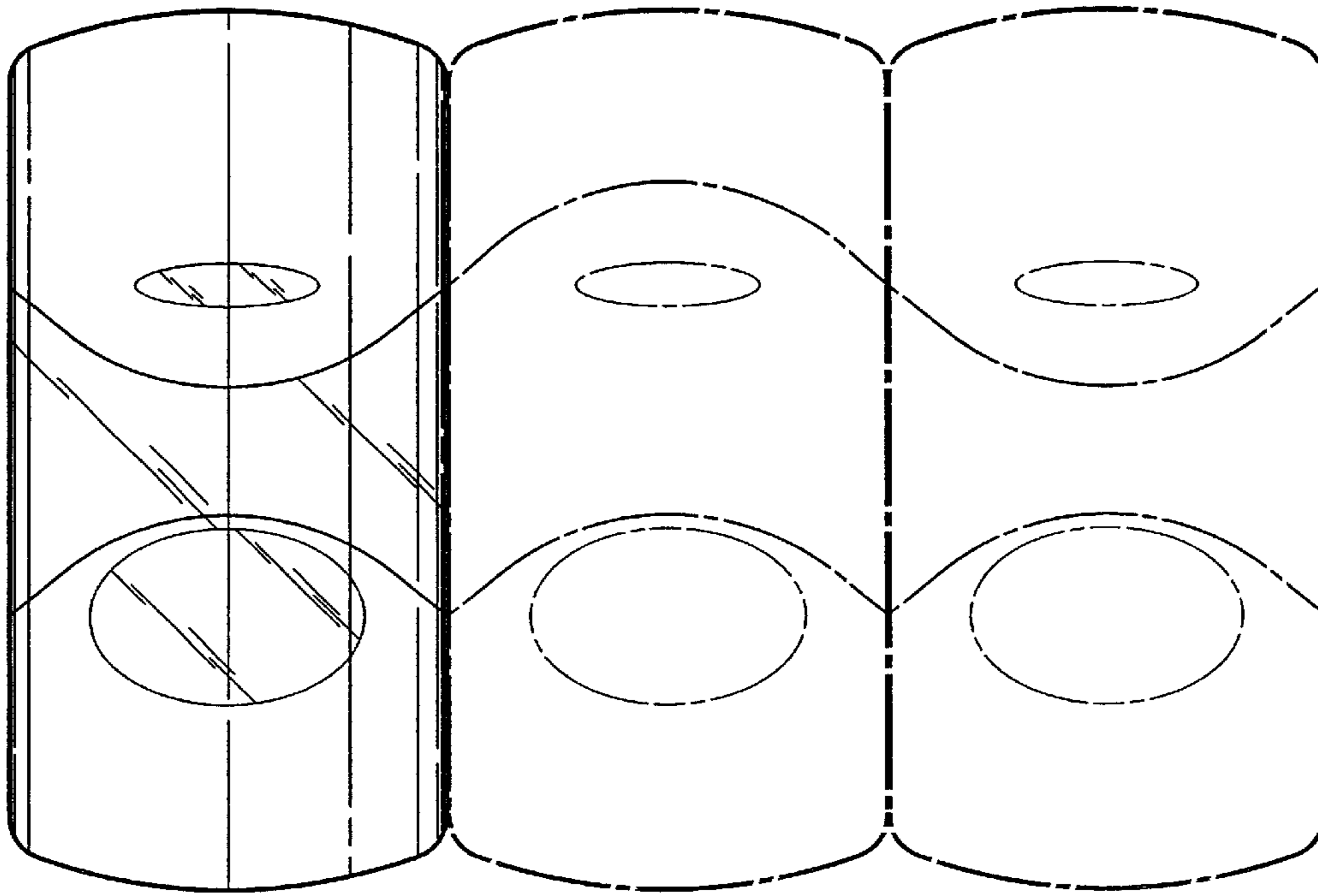

FIG. 13

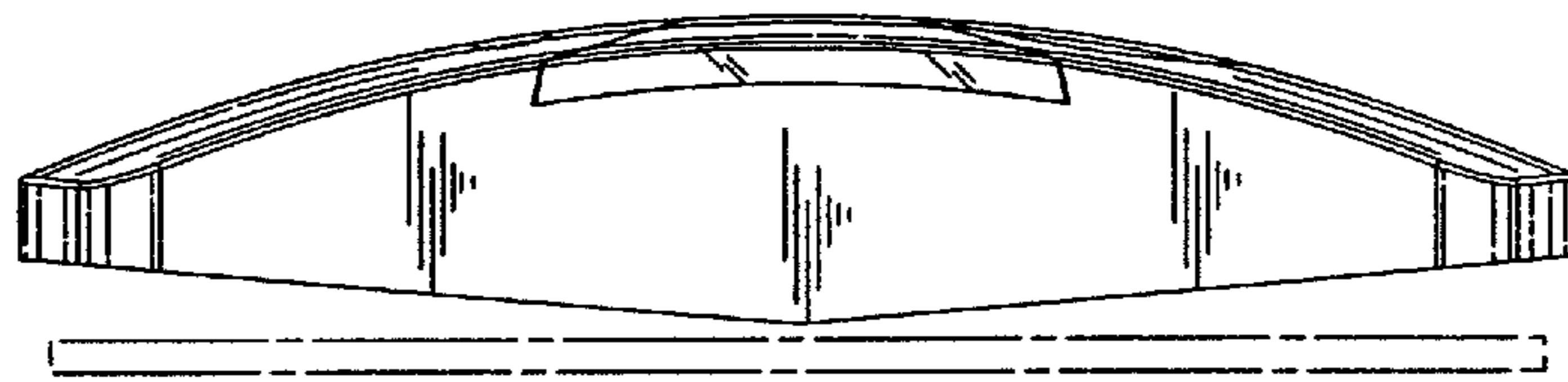

FIG. 14

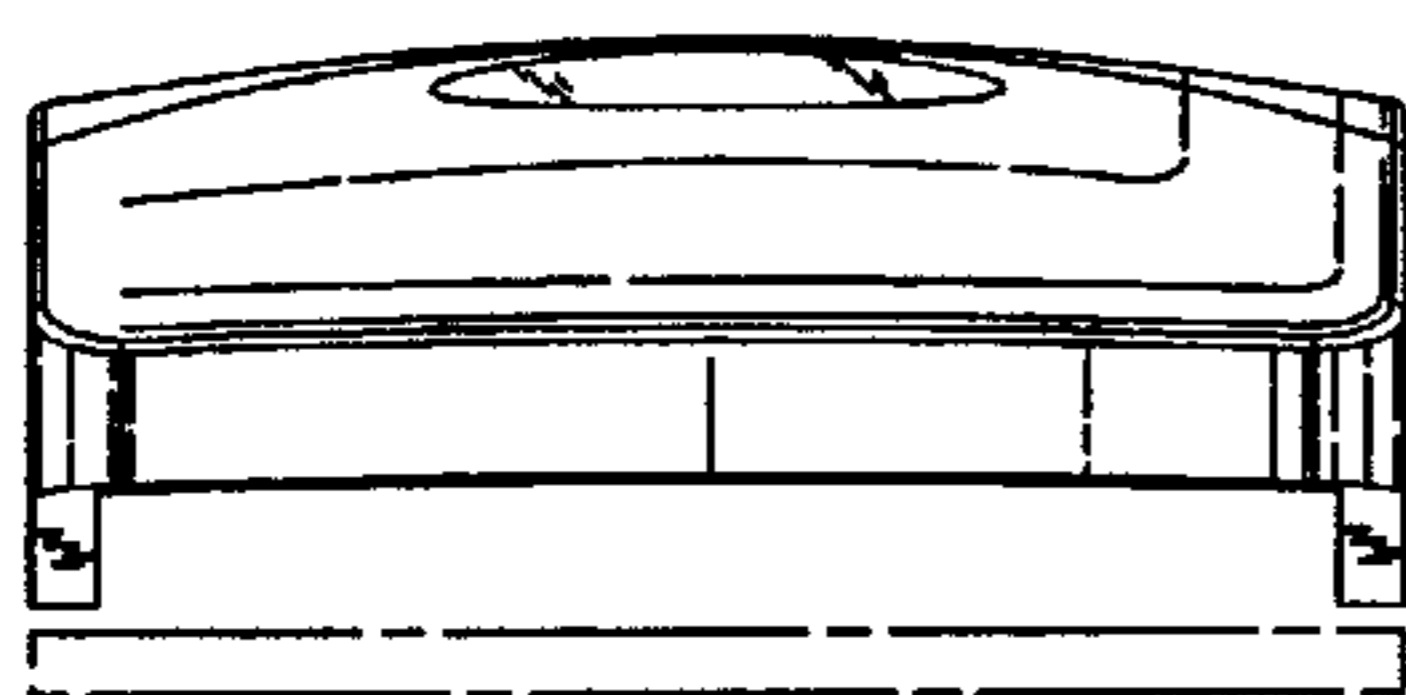

FIG. 15

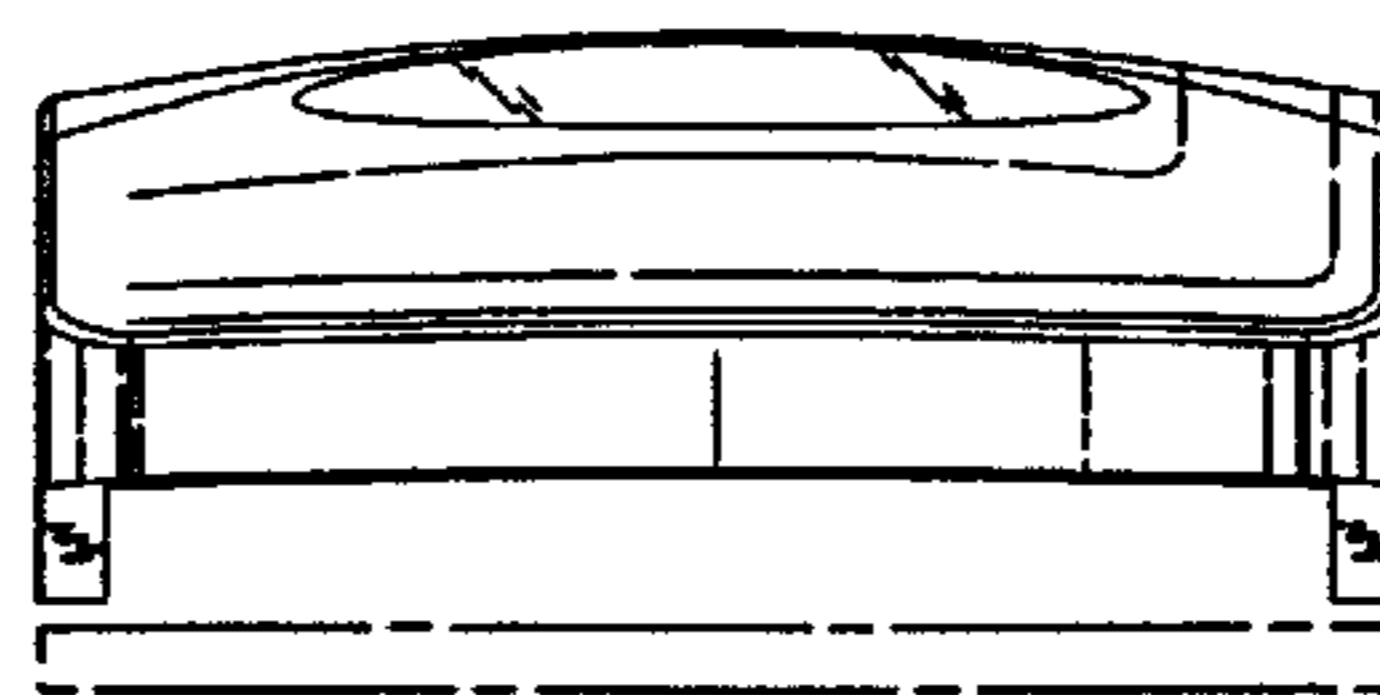

FIG. 16

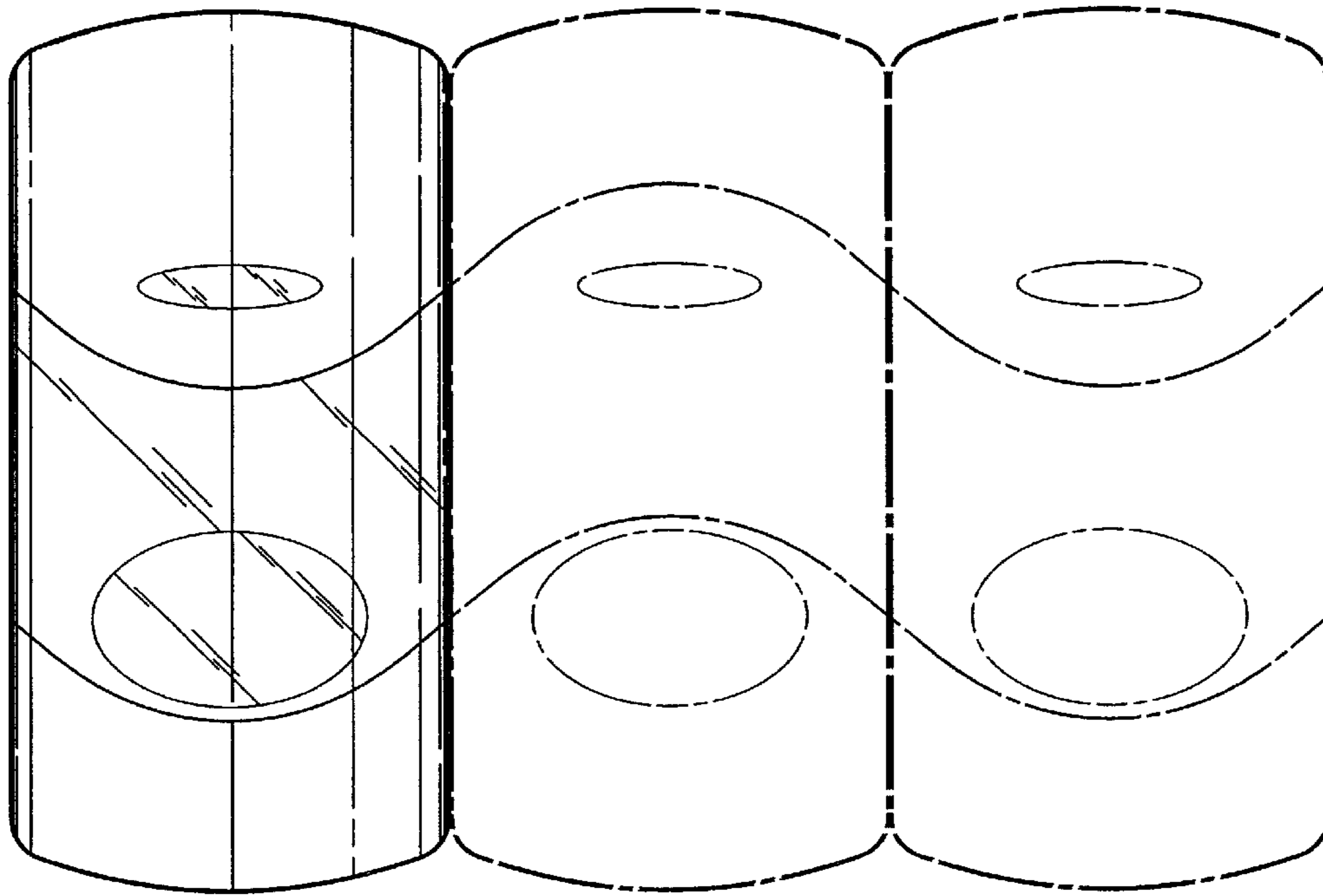

FIG. 17

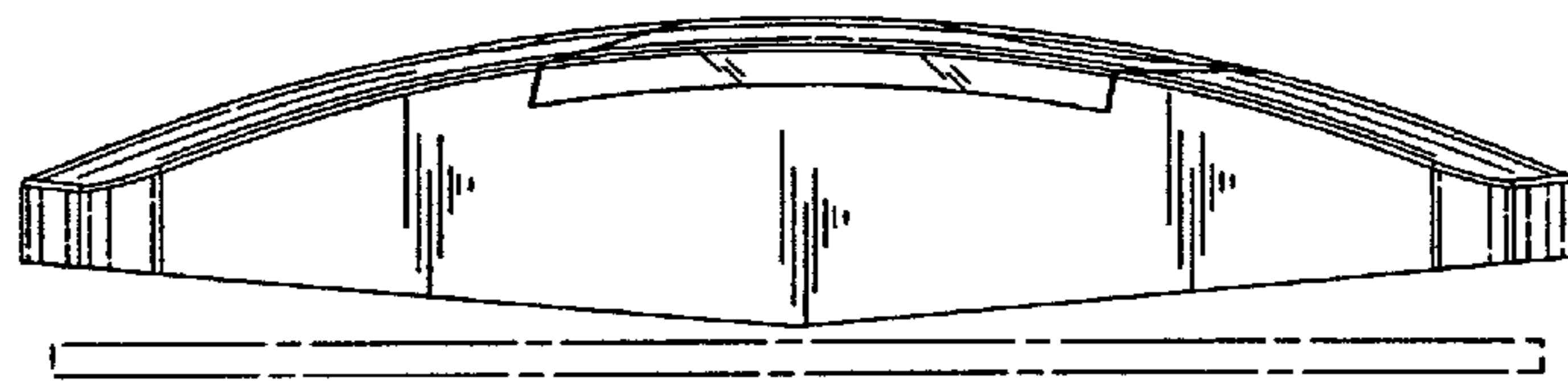

FIG. 18

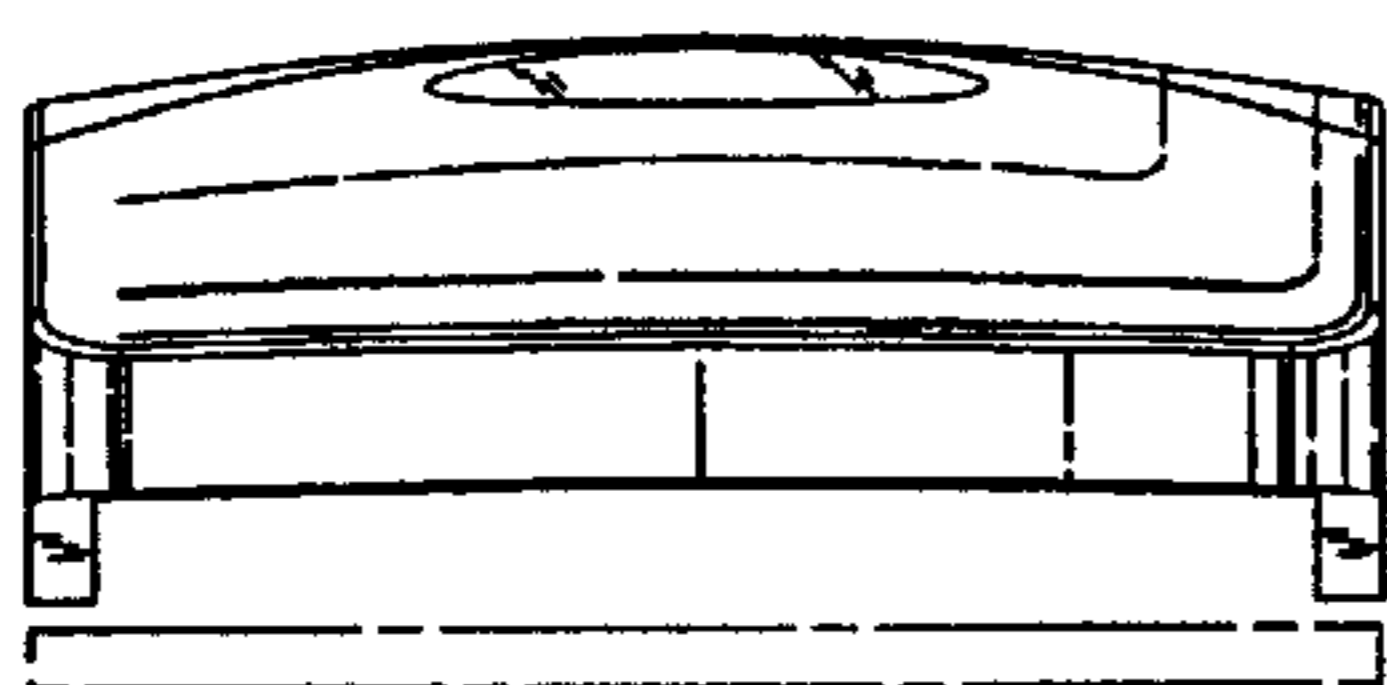

FIG. 19

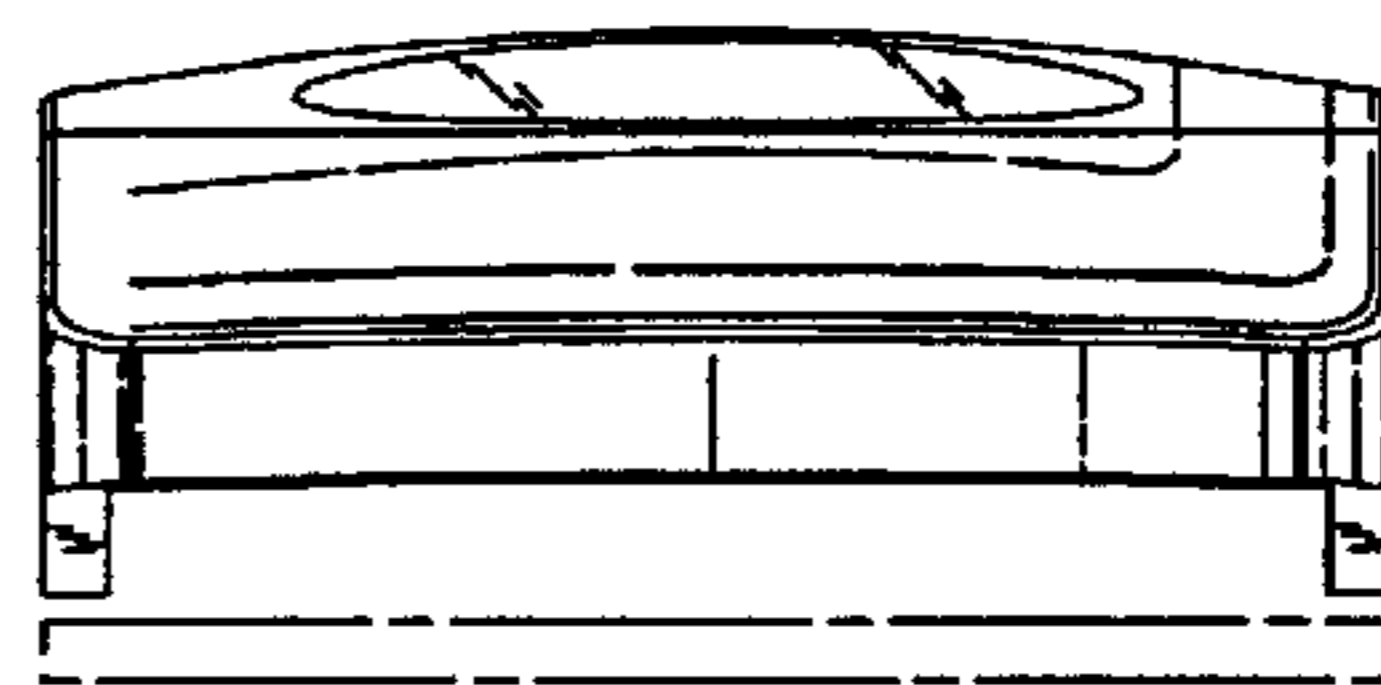

FIG. 20