



US00D518432S

(12) **United States Design Patent**  
**Bucaccio et al.**

(10) **Patent No.:** **US D518,432 S**

(45) **Date of Patent:** **\*\* Apr. 4, 2006**

(54) **SET OF PERSONAL WATERCRAFT SIDE PANELS**

(75) Inventors: **Tom Bucaccio**, Sebastian, FL (US);  
**Shannon Cassell**, Palm Bay, FL (US);  
**Kirk Aguero**, Indialantic, FL (US)

(73) Assignee: **Bombardier Recreational Products Inc.**, Valcourt (CA)

(\*\*) Term: **14 Years**

(21) Appl. No.: **29/235,795**

(22) Filed: **Aug. 8, 2005**

**Related U.S. Application Data**

(62) Division of application No. 29/211,683, filed on Aug. 20, 2004.

(51) **LOC (8) Cl.** ..... **12-06**

(52) **U.S. Cl.** ..... **D12/307; D12/317**

(58) **Field of Classification Search** ..... D12/300,  
D12/307, 316, 317; 114/55.5, 55.55, 55.57,  
114/270, 271; D21/542

See application file for complete search history.

(56) **References Cited**

**U.S. PATENT DOCUMENTS**

D340,221 S \* 10/1993 Krieger et al. .... D12/307  
D342,052 S \* 12/1993 Schoell et al. .... D12/307  
D343,160 S 1/1994 LaPointe  
D350,325 S 9/1994 Mardikian

D359,469 S \* 6/1995 Yoshida et al. .... D12/307  
D444,761 S \* 7/2001 Momoi et al. .... D12/307  
D464,926 S 10/2002 Mizuta et al.  
D478,035 S \* 8/2003 Bills et al. .... D12/317  
D479,702 S 9/2003 Cassell et al.  
D485,527 S \* 1/2004 Cassell et al. .... D12/307  
D487,244 S \* 3/2004 Bucaccio et al. .... D12/307  
D494,529 S \* 8/2004 Cassell et al. .... D12/307  
D507,230 S \* 7/2005 Bucaccio et al. .... D12/317

\* cited by examiner

*Primary Examiner*—Cynthia M. Chin

(74) *Attorney, Agent, or Firm*—BRP Legal Services

(57) **CLAIM**

The ornamental design for a set of personal watercraft side panels, as shown and described.

**DESCRIPTION**

FIG. 1 is a front-right perspective view of a set of personal watercraft side panels according to our design;

FIG. 2 is a front view thereof;

FIG. 3 is a rear view thereof;

FIG. 4 is a top view thereof;

FIG. 5 is a left view thereof; and,

FIG. 6 is a right view thereof.

Where included, the broken lines showing environment or structure are for illustrative purposes only and form no part of claimed design.

The portions of the set of personal watercraft side panels which are not shown in the drawings form no part of the claimed design.

**1 Claim, 5 Drawing Sheets**

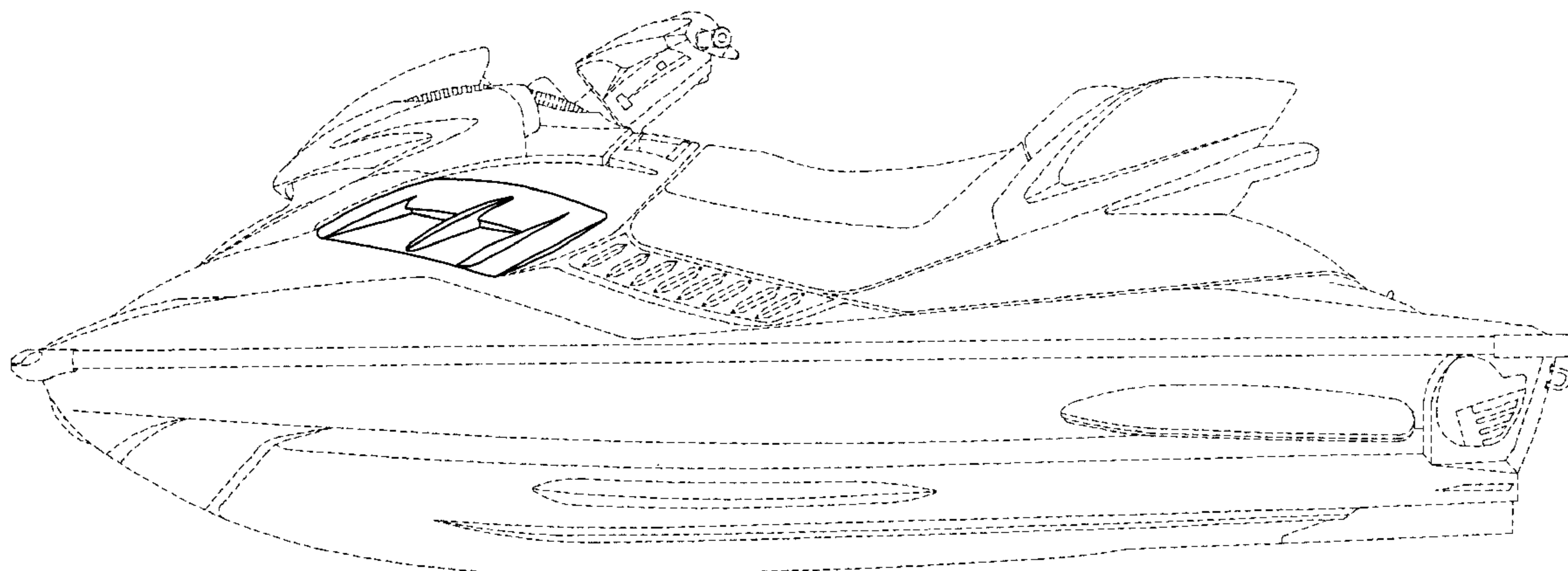

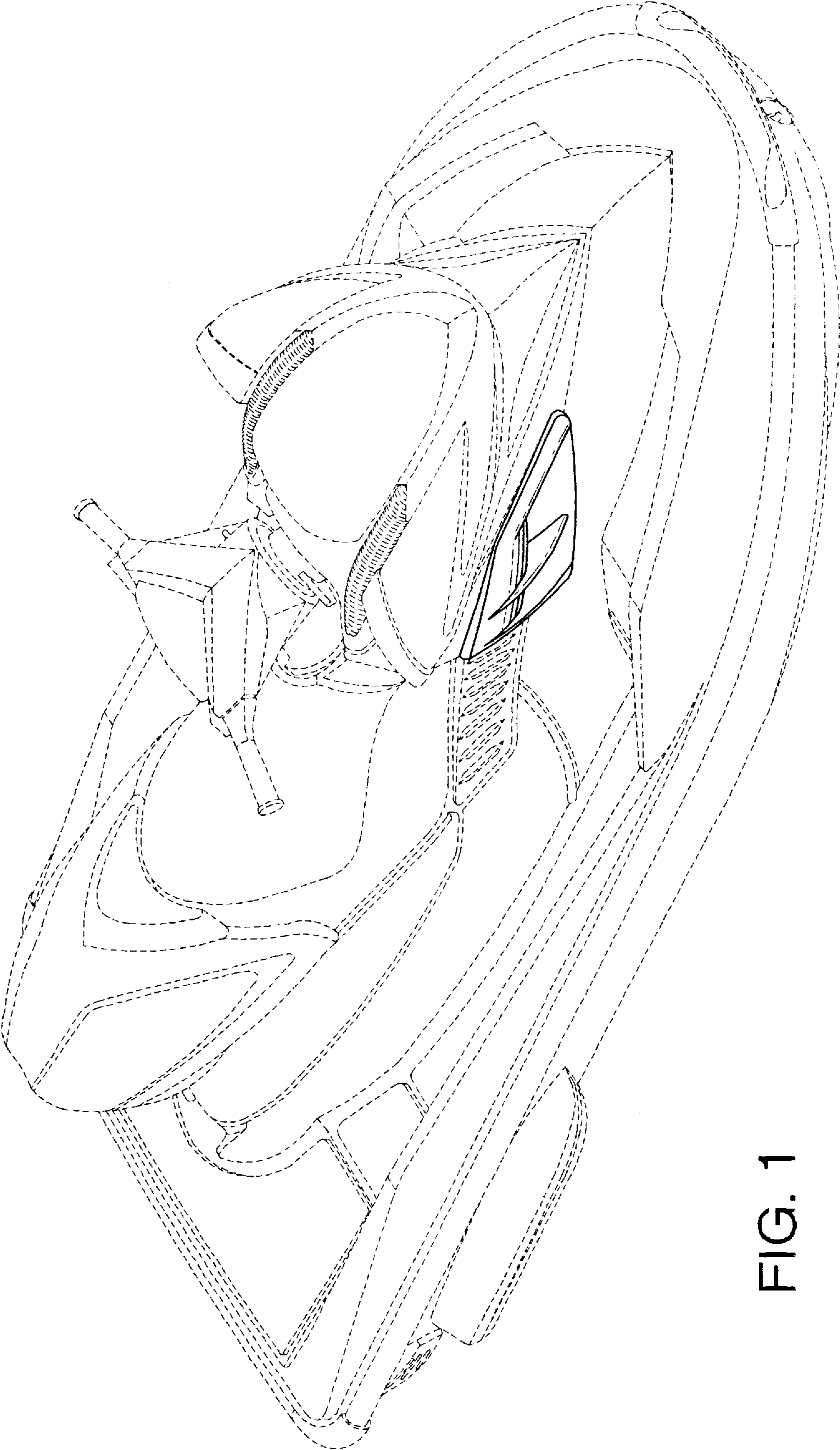

FIG. 1

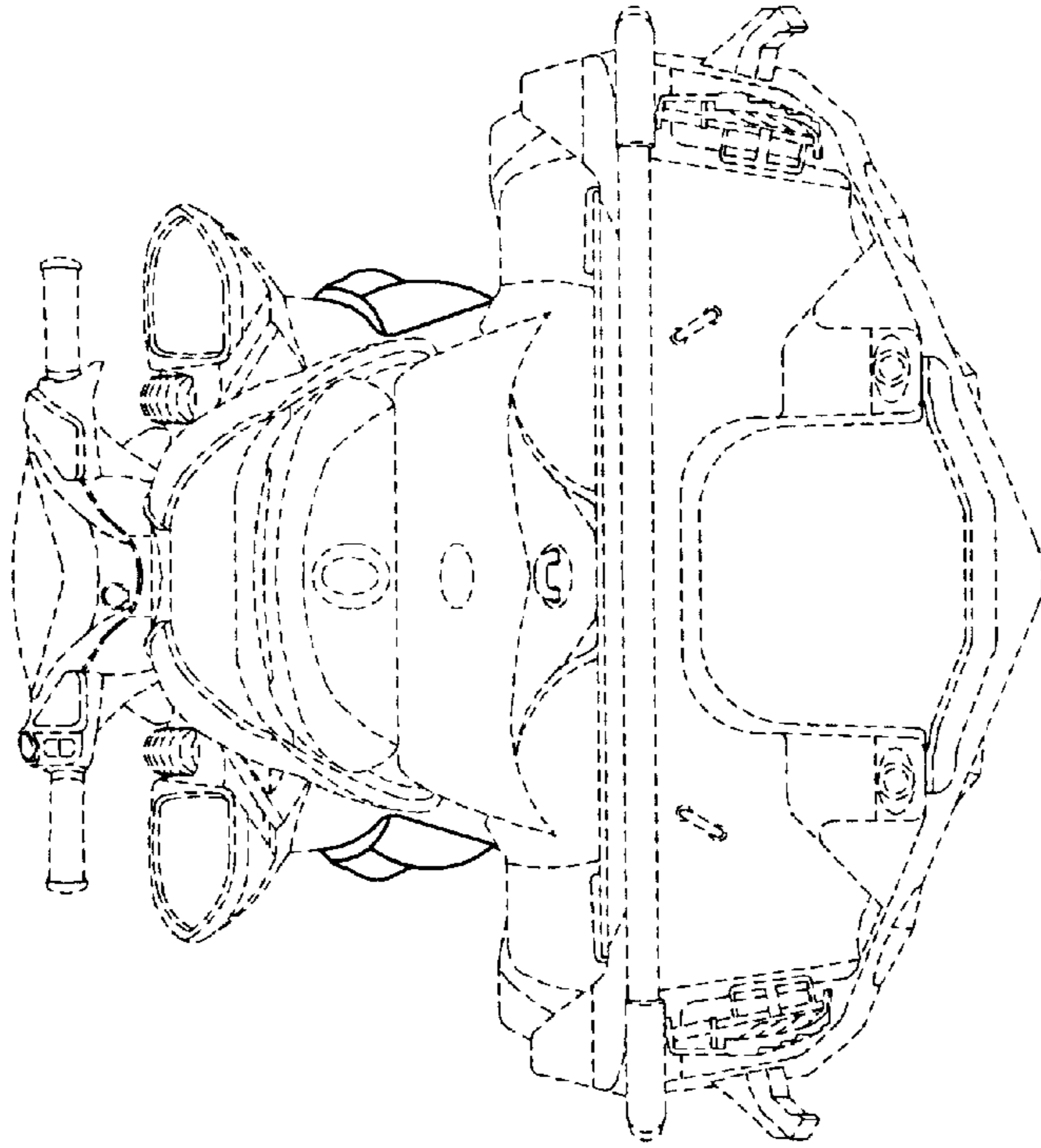

FIG. 2

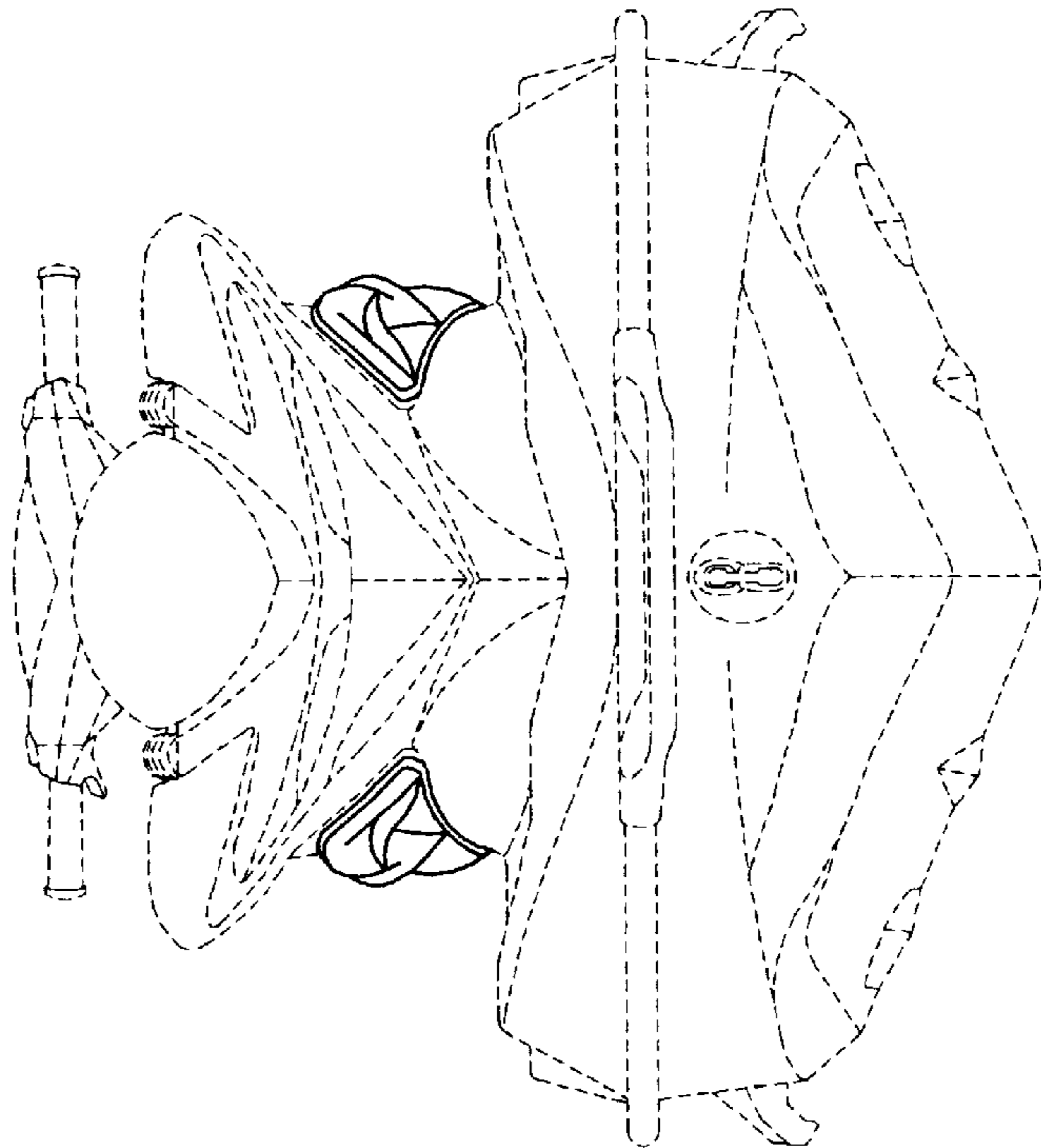

FIG. 3

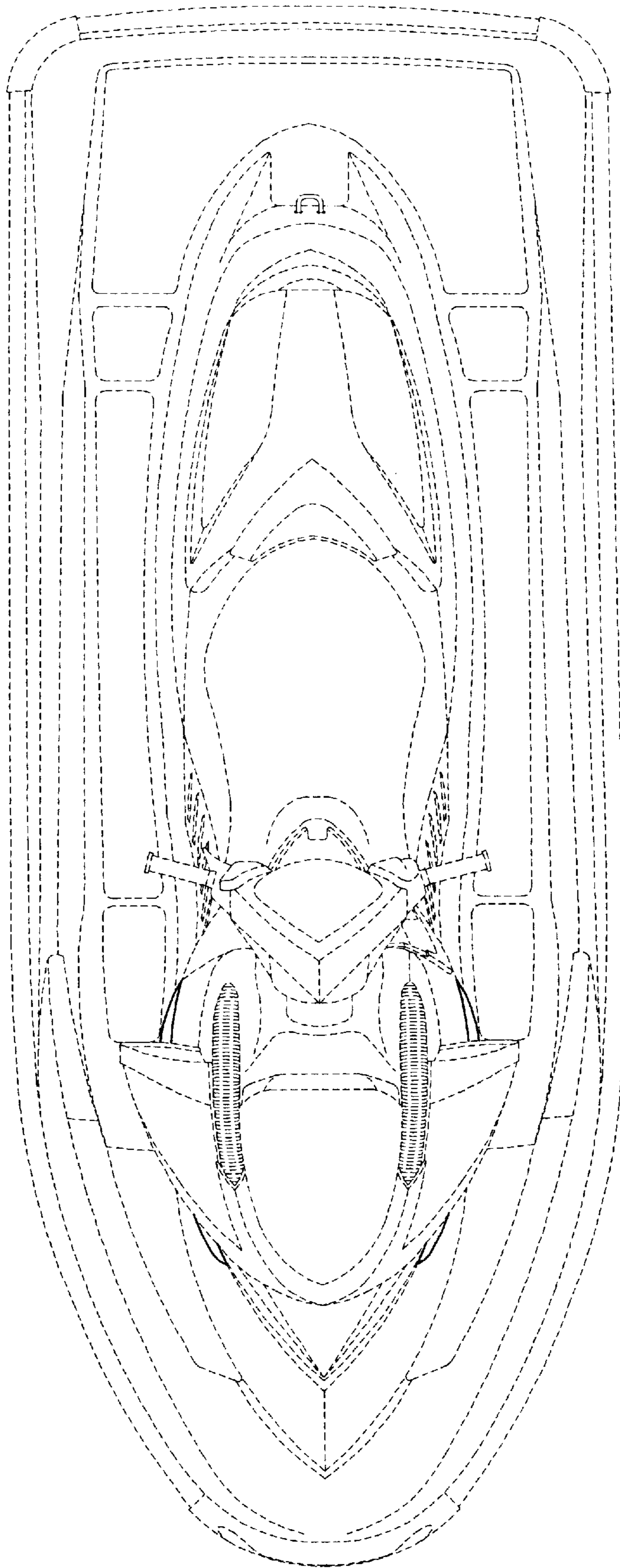

FIG. 4

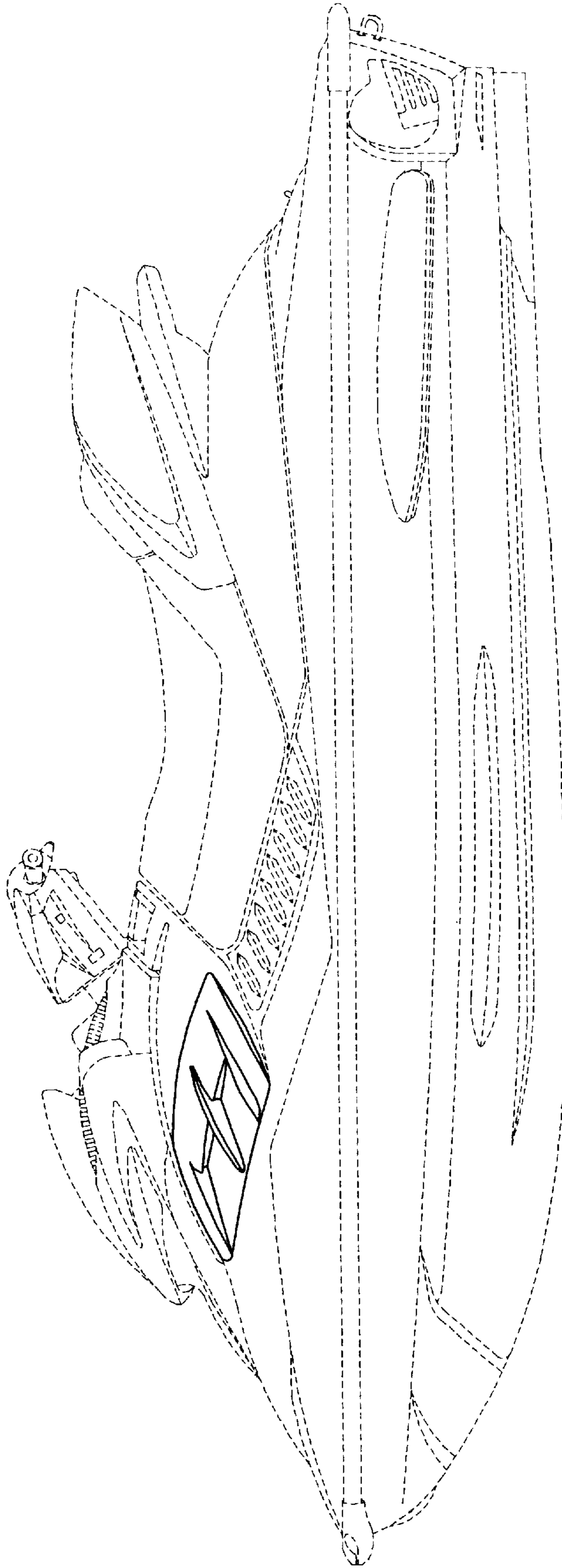

FIG. 5

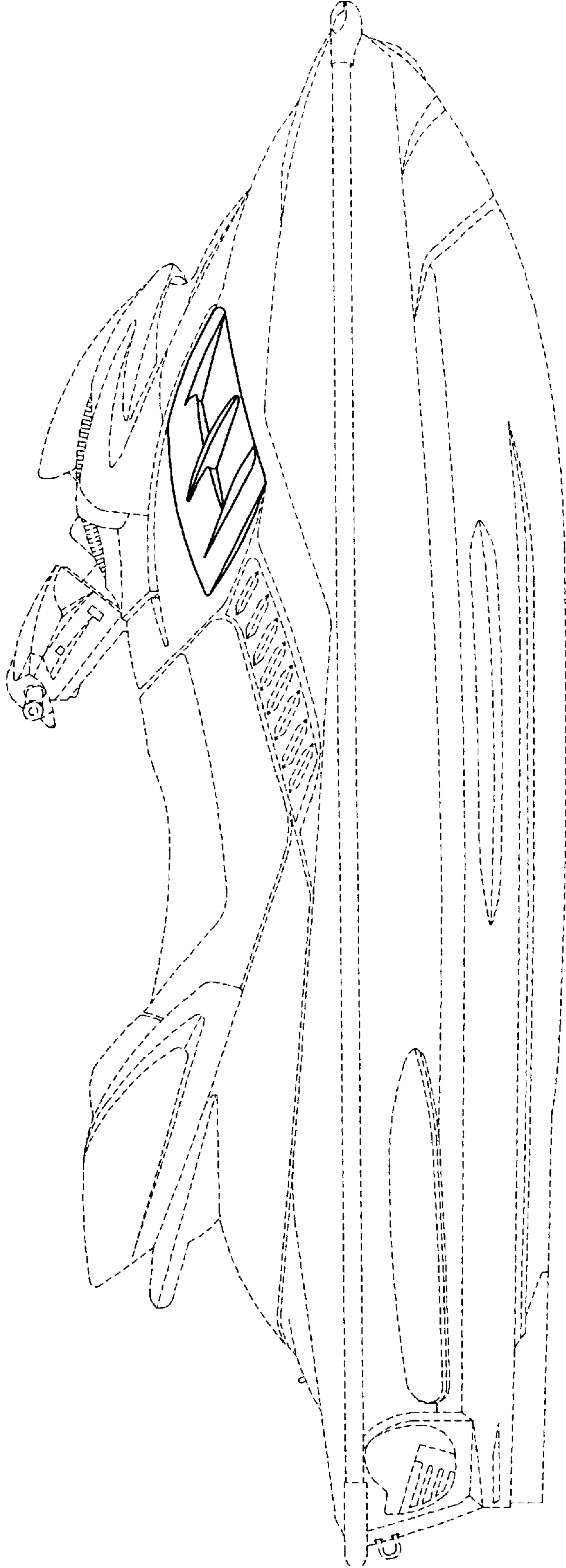

FIG. 6