



US00D518345S

(12) **United States Design Patent**
Peterson

(10) **Patent No.:** **US D518,345 S**

(45) **Date of Patent:** **** Apr. 4, 2006**

(54) **SCISSORS**

(75) Inventor: **Michael Peterson**, Fairfield, CT (US)

(73) Assignee: **Acme United Corporation**, Fairfield, CT (US)

(**) Term: **14 Years**

(21) Appl. No.: **29/189,363**

(22) Filed: **Sep. 3, 2003**

(51) **LOC (8) Cl.** **08-03**

(52) **U.S. Cl.** **D8/57**

(58) **Field of Classification Search** D8/57,
D8/107; 7/135, 136; 30/131, 195, 358, 229-262
See application file for complete search history.

(56) **References Cited**

U.S. PATENT DOCUMENTS

D295,493 S *	5/1988	Vigano'	D8/57
6,243,954 B1 *	6/2001	Bowers	30/233
6,557,263 B1 *	5/2003	Yeh	30/226
D485,736 S *	1/2004	Phillips et al.	D8/57
2004/0168324 A1 *	9/2004	Buchtman et al.	30/173

OTHER PUBLICATIONS

Guernsey Office Products' 2001 General Line Catalog (c)2000. (3 pages) Item "L" on p. 975; Items "S" and "T" on p. 976 and Item "A" on p. 977.*

* cited by examiner

Primary Examiner—Clare E Heflin

(74) *Attorney, Agent, or Firm*—Whyte Hirschoeck Dudek S.C.

(57) **CLAIM**

The ornamental design for the scissors, as shown and described in the accompanying figures.

DESCRIPTION

FIG. 1 is a perspective view of the scissors according to the present invention;

FIG. 2 is a front plan view of the scissors of FIG. 1;

FIG. 3 is a rear plan view of the scissors, rotated 180 degrees from the view of FIG. 2, of the scissors of FIG. 1;

FIG. 4 is a left side view of the scissors of FIG. 1, the right side view being a mirror image thereof;

FIG. 5 is a first end view of the scissors of FIG. 1; and

FIG. 6 is a second, opposite end view of the scissors of FIG. 1;

FIG. 7 is a perspective view of an alternative embodiment of the scissors of FIG. 1;

FIG. 8 is a front plan view of the scissors of FIG. 7;

FIG. 9 is a rear plan view of the scissors, rotated 180 degrees from the view of FIG. 8, of the scissors of FIG. 7;

FIG. 10 is a left side view of the scissors of FIG. 7, the right side view being a mirror image thereof;

FIG. 11 is a first end view of the scissors of FIG. 7; and,

FIG. 12 is a second, opposite end view of the scissors of FIG. 7.

The broken lines shown on the drawings are for illustrative purposes only and form no part of the claimed design.

1 Claim, 6 Drawing Sheets

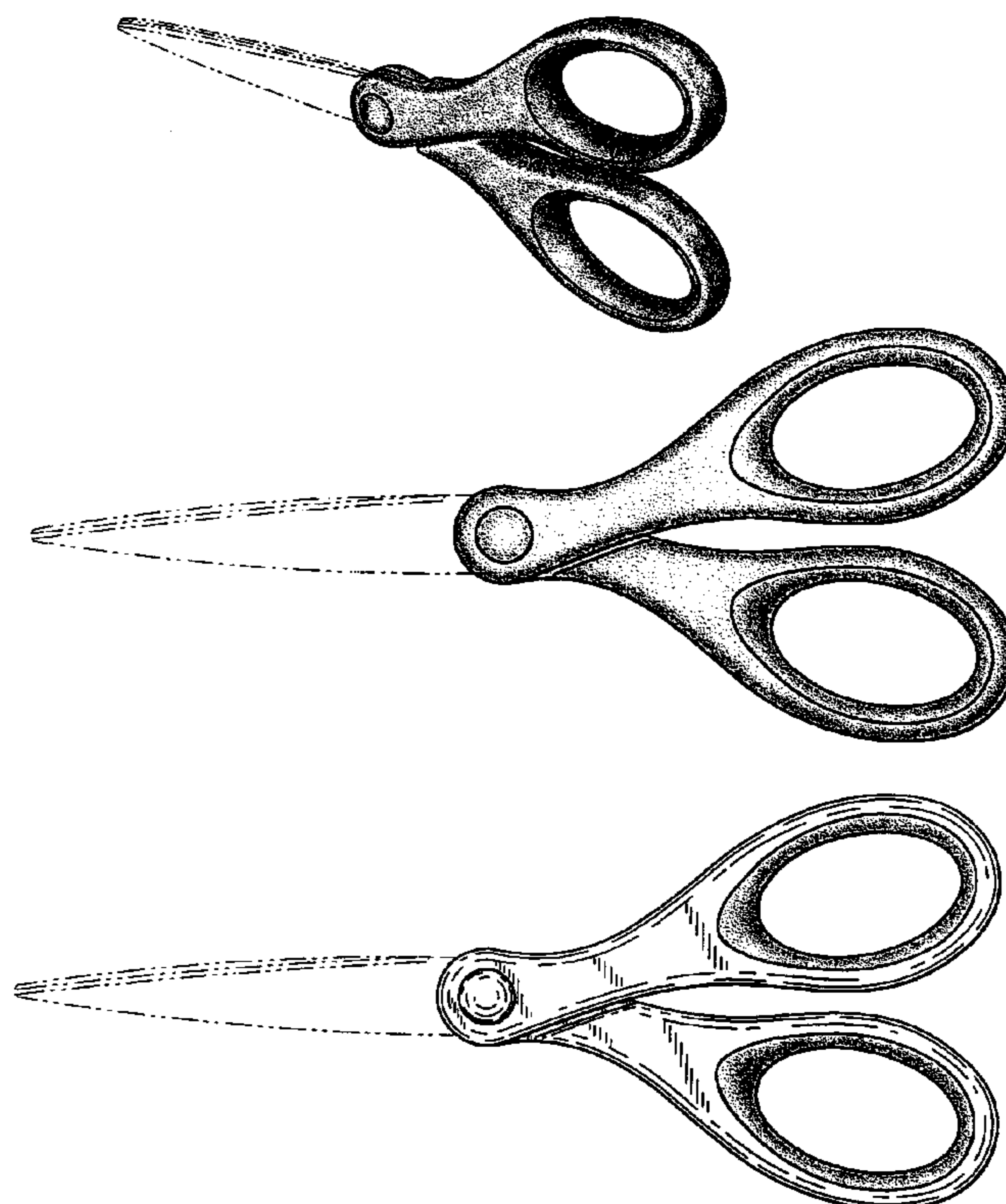

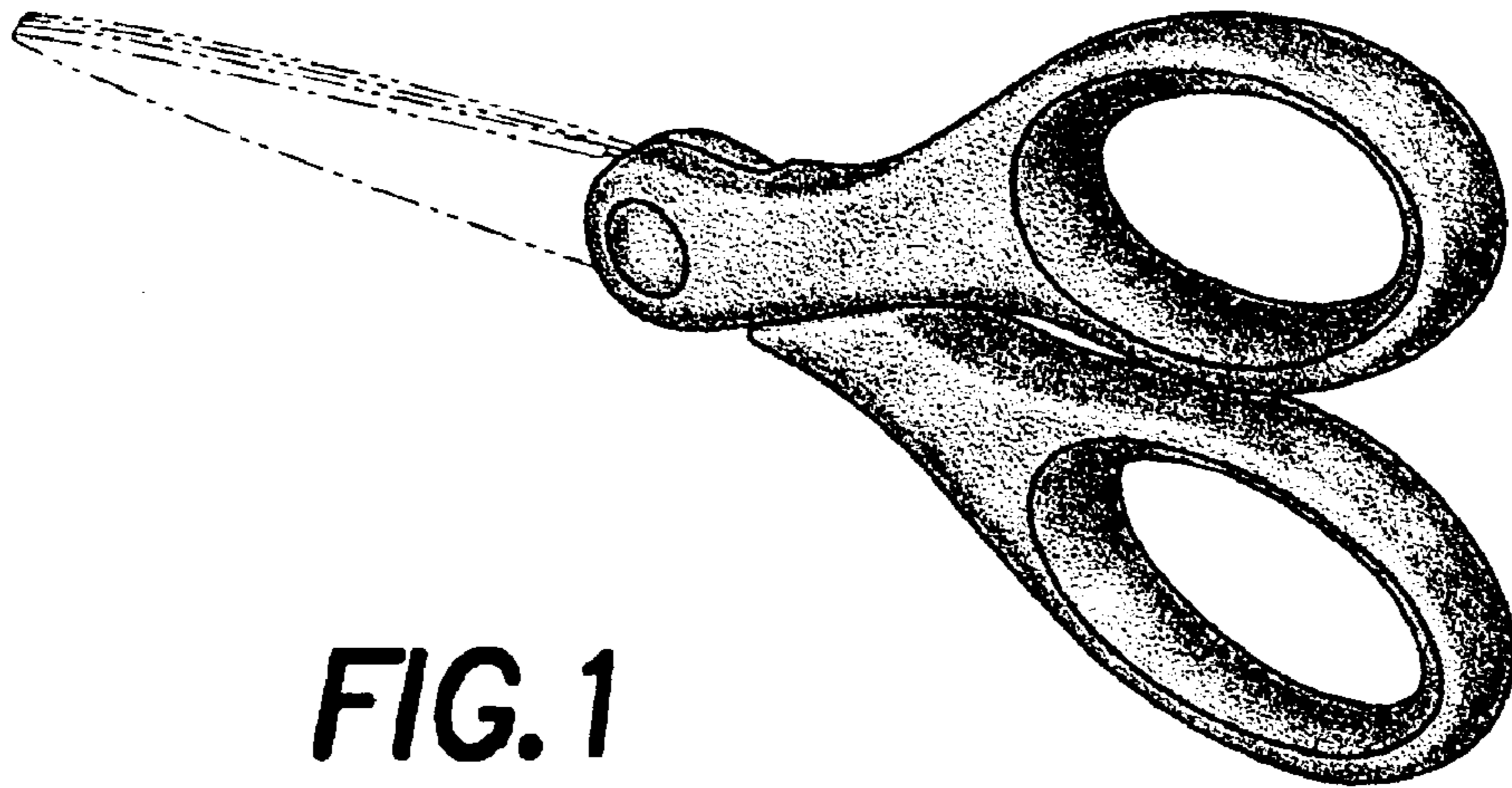

FIG. 1

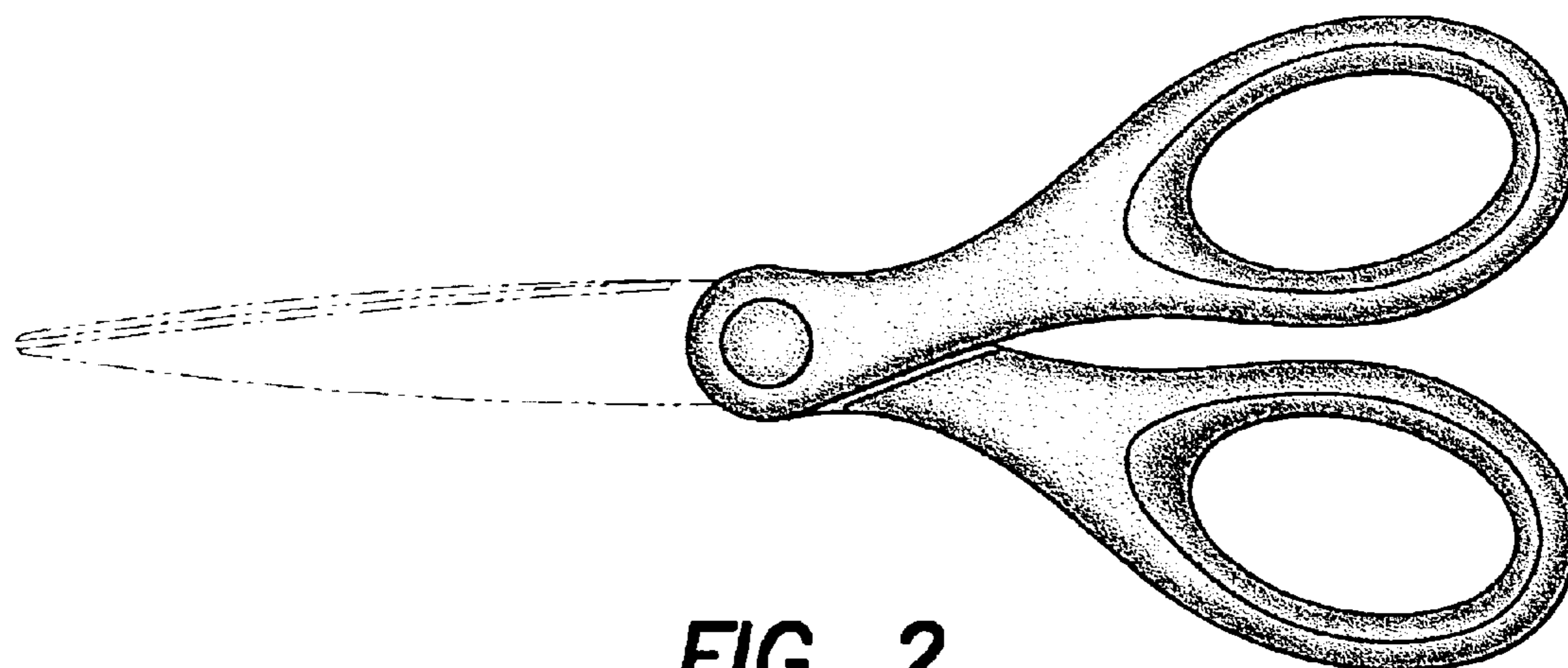

FIG. 2

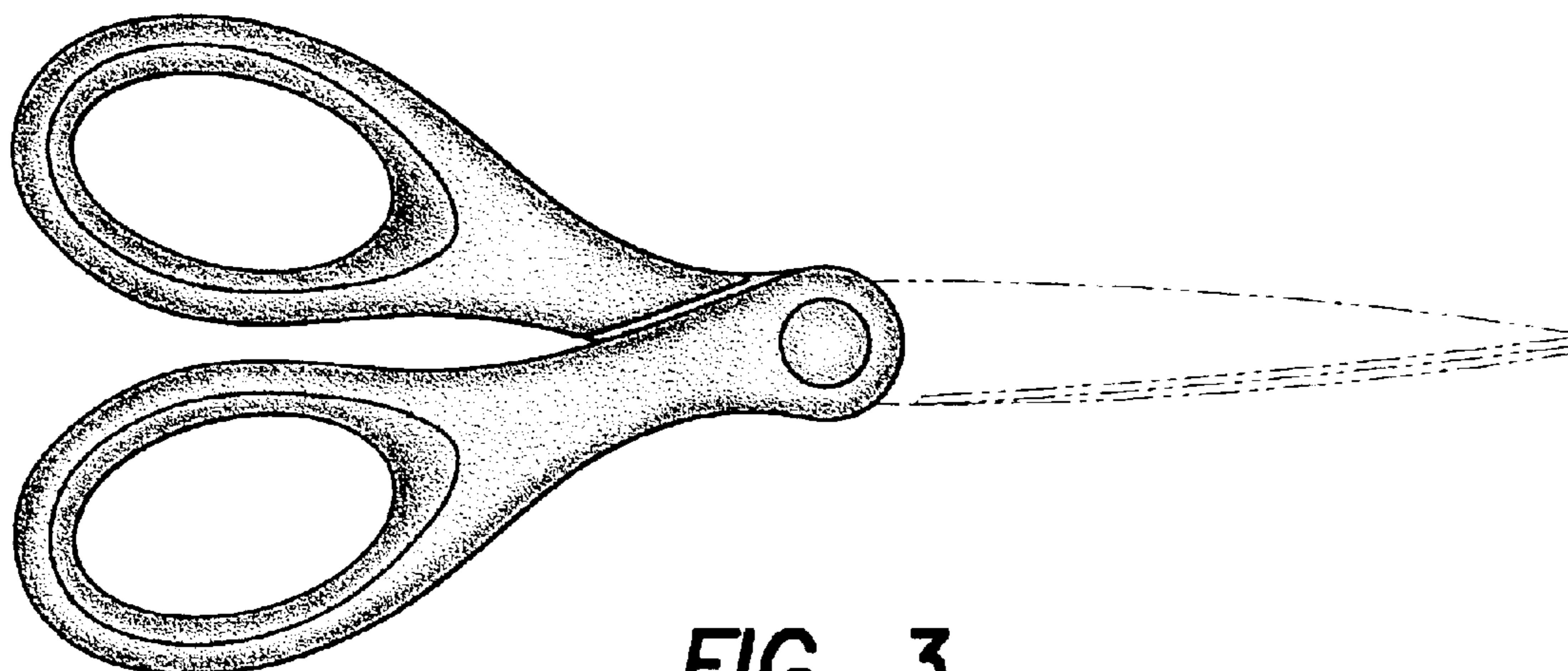

FIG. 3

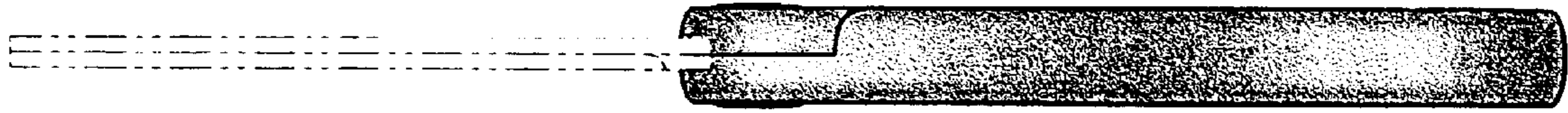

FIG. 4



FIG. 5



FIG. 6

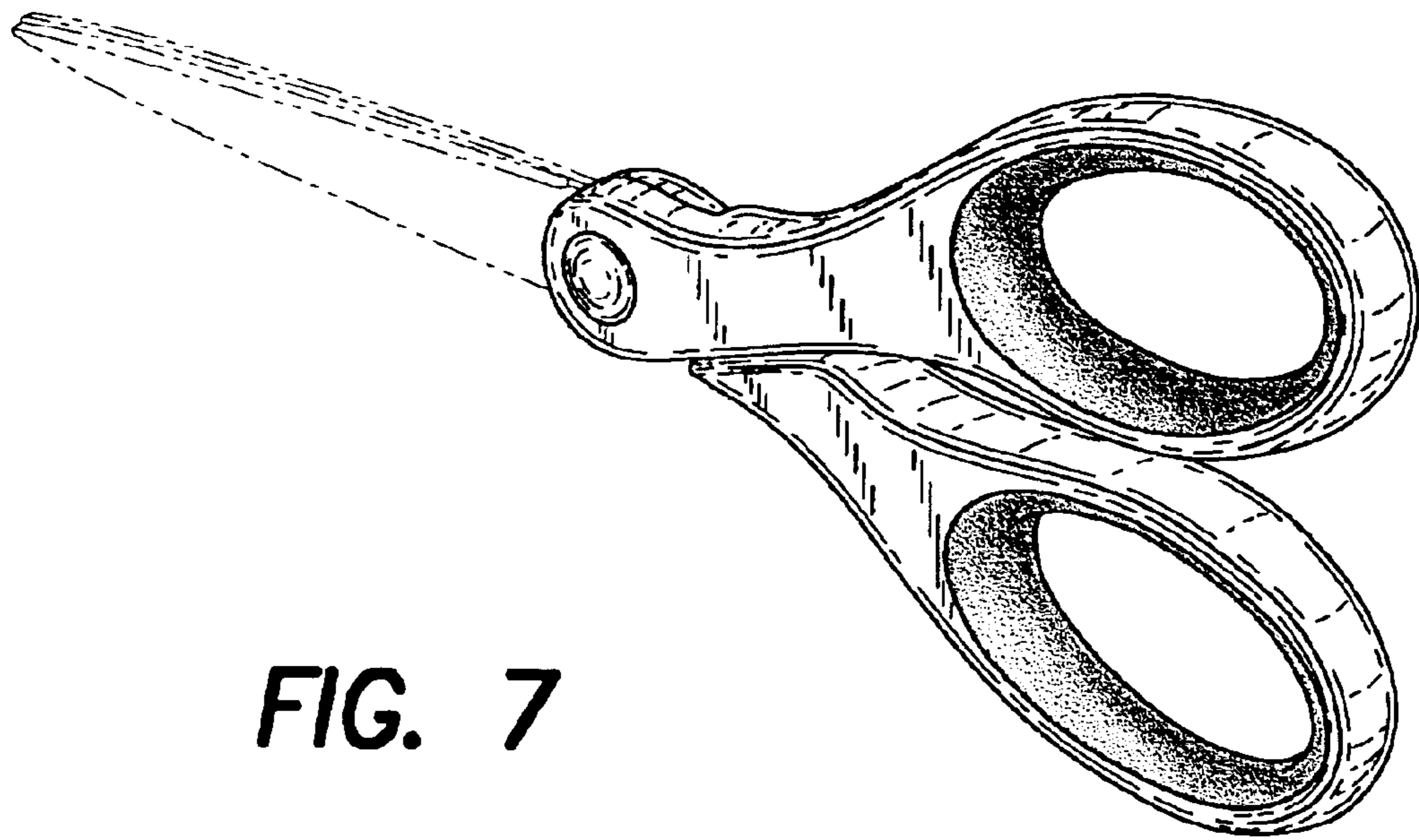

FIG. 7

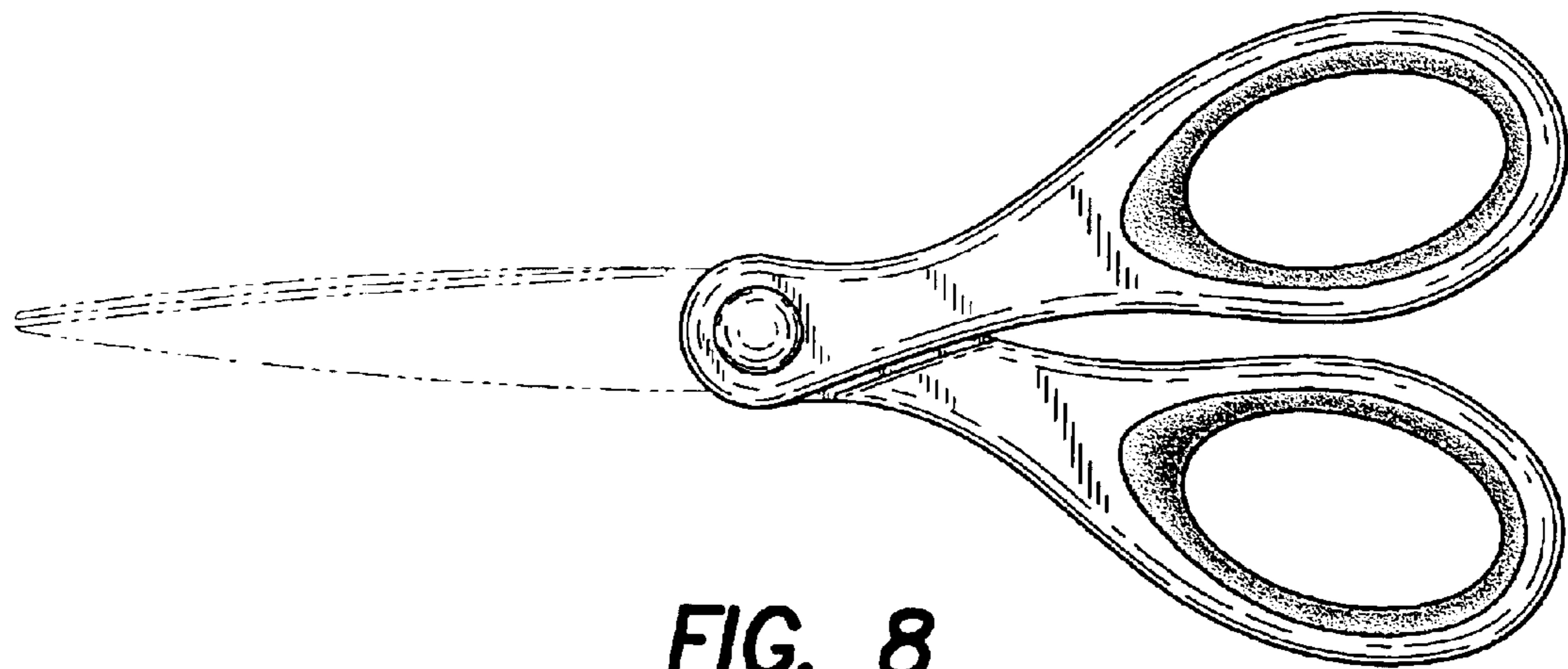

FIG. 8

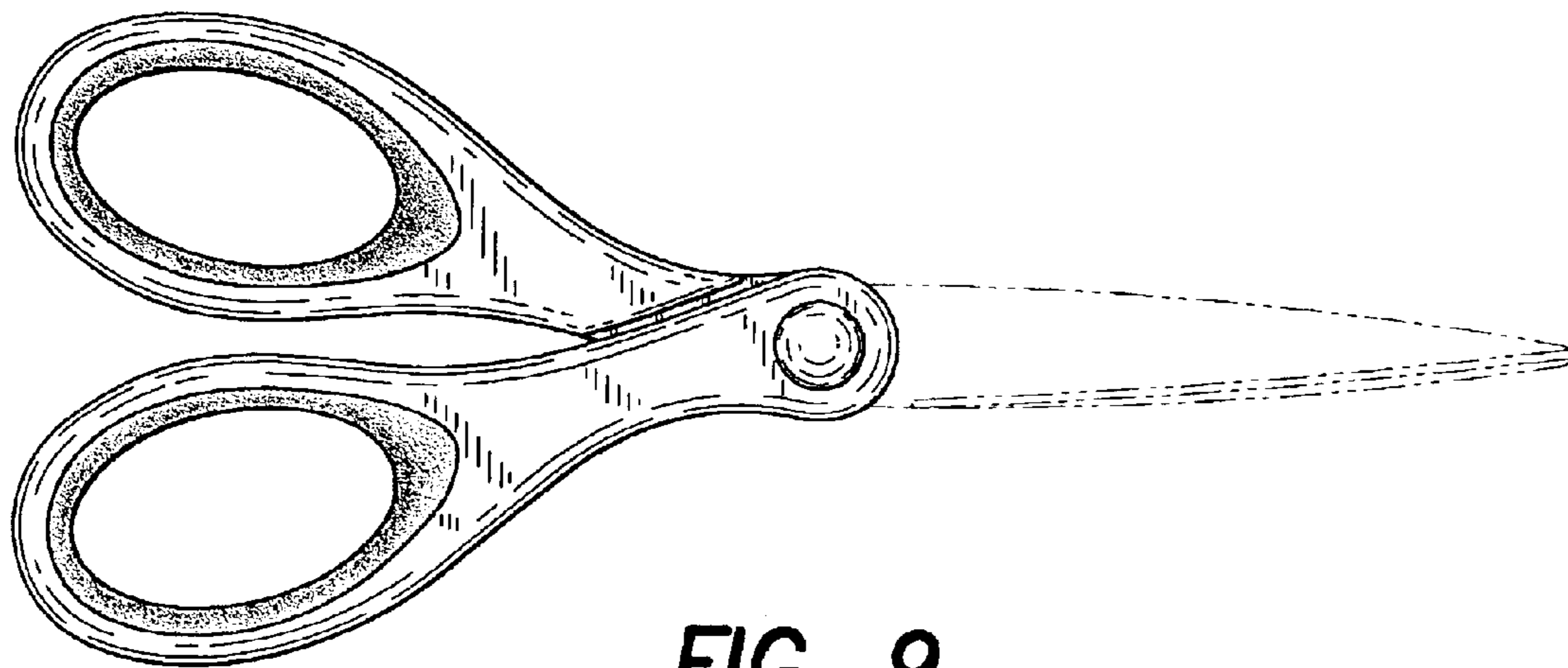

FIG. 9

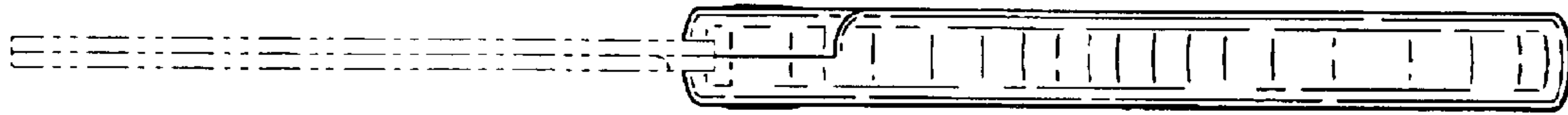

FIG. 10



FIG. 11



FIG. 12