



US00D518332S

(12) **United States Design Patent**
Feil

(10) **Patent No.:** **US D518,332 S**

(45) **Date of Patent:** **** Apr. 4, 2006**

(54) **FOOD PROCESSOR ATTACHMENT**

(75) Inventor: **Rolf Feil**, Günzburg (DE)

(73) Assignee: **BSH und Siemens Hausgeraete GmbH**, Munich (DE)

(**) Term: **14 Years**

(21) Appl. No.: **29/180,855**

(22) Filed: **May 1, 2003**

(30) **Foreign Application Priority Data**

Nov. 1, 2002 (DE) DM/062267

(51) **LOC (8) Cl.** **31-00**

(52) **U.S. Cl.** **D7/412**

(58) **Field of Classification Search** D7/376,
D7/384, 412, 669; 241/282.1–282.2, 273.1,
241/291; 366/64–67, 98, 100, 241, 242, 244,
366/247, 279, 282, 325.9, 2, 329.11, 342,
366/383

See application file for complete search history.

(56) **References Cited**

U.S. PATENT DOCUMENTS

3,645,310 A * 2/1972 Hartley 241/85

4,364,525 A * 12/1982 McClean 241/92
D362,793 S * 10/1995 Khan et al. D7/688
5,713,664 A * 2/1998 Harilela 366/129
D400,050 S * 10/1998 Littmann D7/412
5,885,001 A * 3/1999 Thomas 366/308

* cited by examiner

Primary Examiner—Caron D. Veynar

Assistant Examiner—Maurice Stevens

(74) *Attorney, Agent, or Firm*—John T. Winburu; Russell W. Warnock; Craig J. Loest

(57) **CLAIM**

The ornamental design for a food processor attachment, as shown and described.

DESCRIPTION

FIG. 1 is a top front right perspective view of the food processor attachment;
FIG. 2 is a front view thereof;
FIG. 3 is a rear view thereof;
FIG. 4 is a top view thereof;
FIG. 5 is a bottom rear left perspective view thereof;
FIG. 6 is a right side view thereof;
FIG. 7 is a left side view thereof; and,
FIG. 8 is a bottom view thereof.

1 Claim, 8 Drawing Sheets

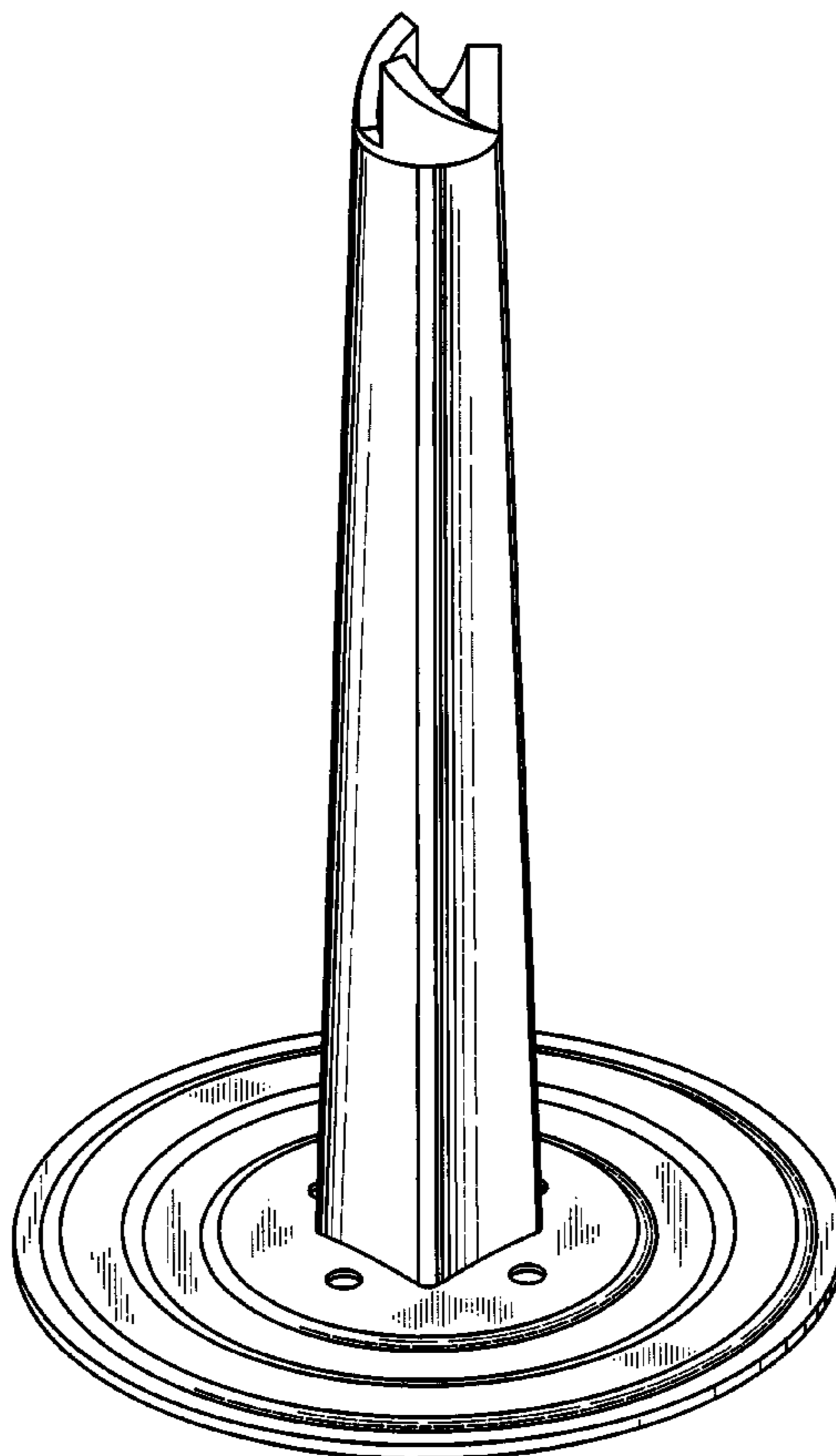

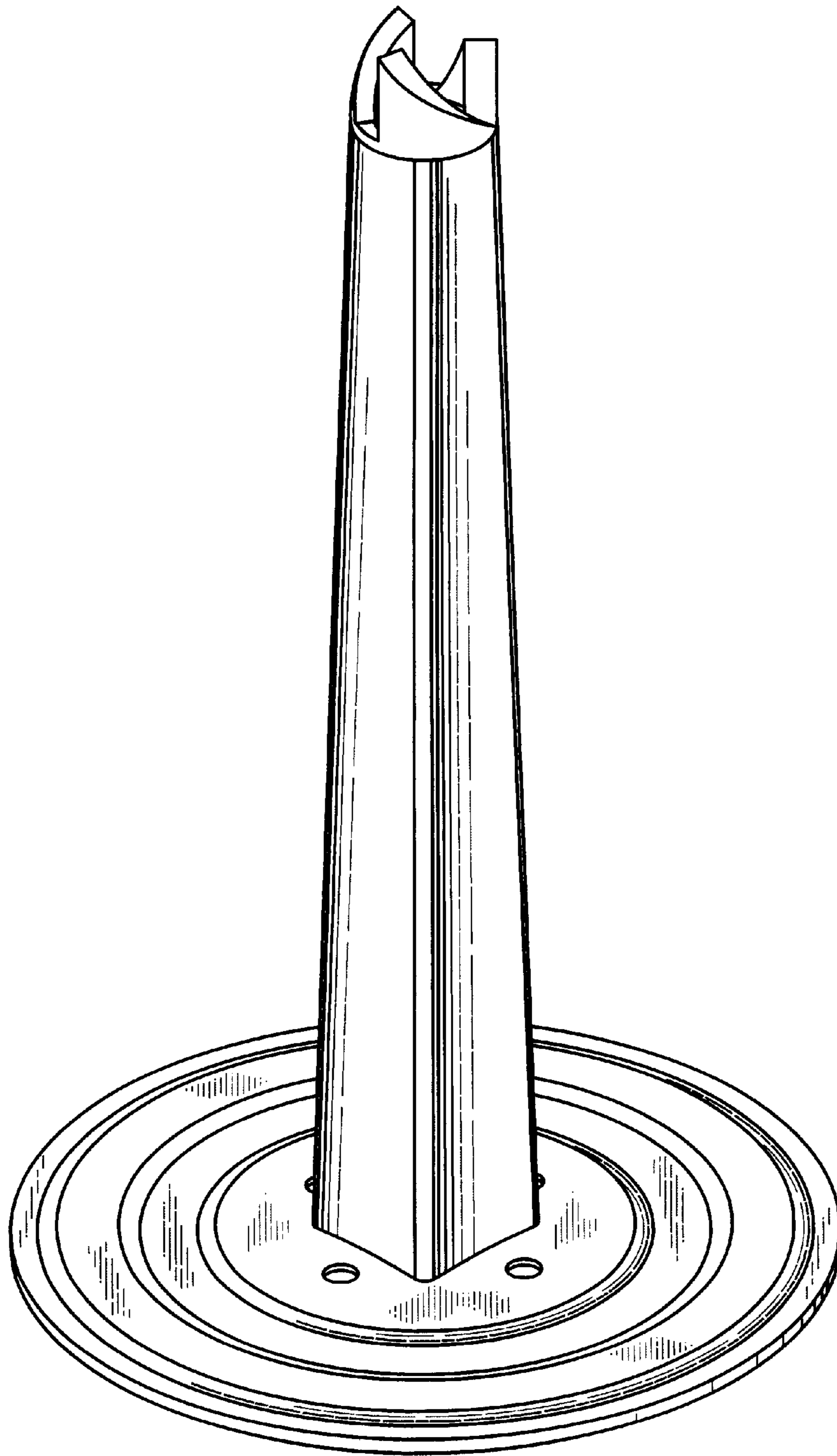

FIG. 1

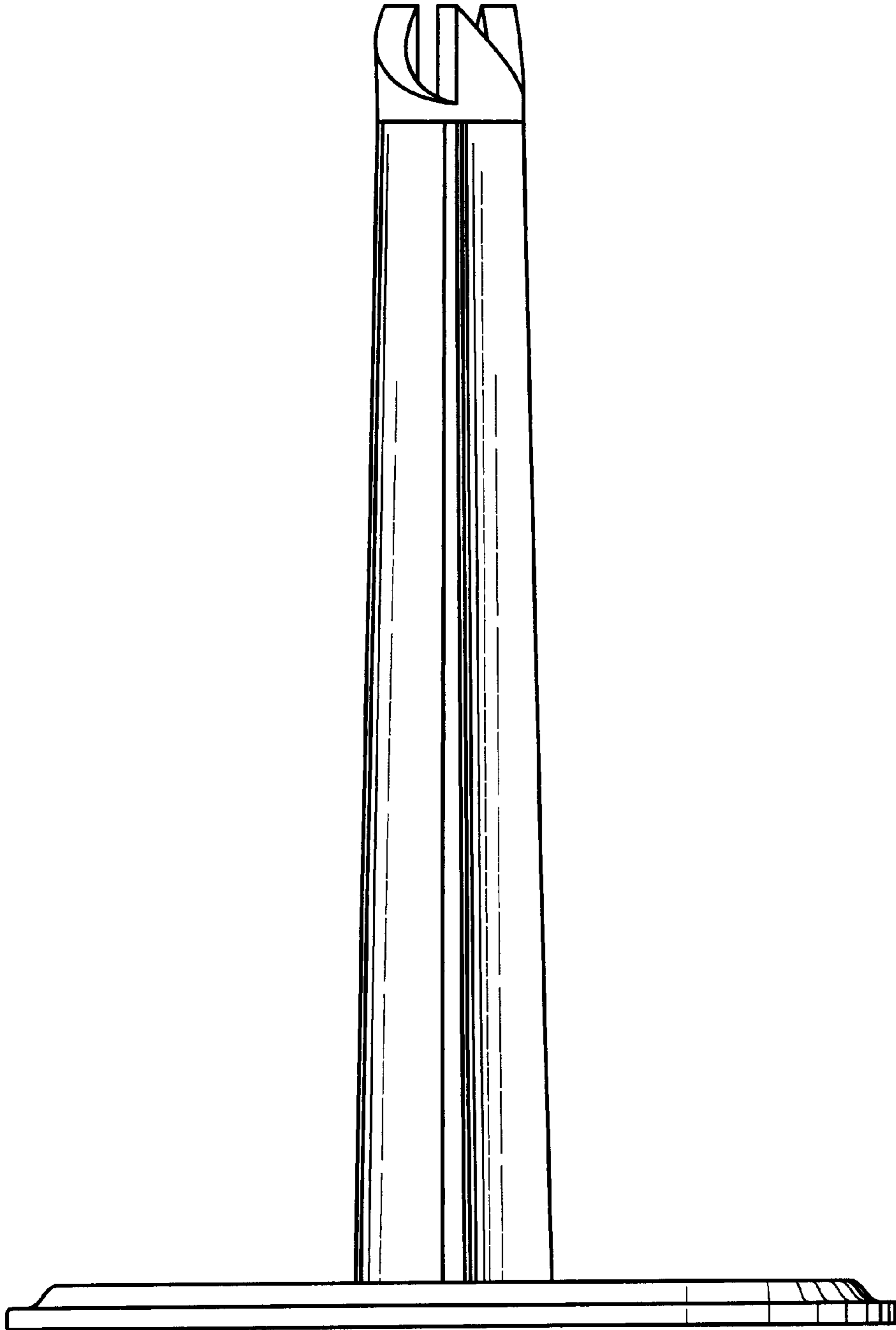

FIG. 2

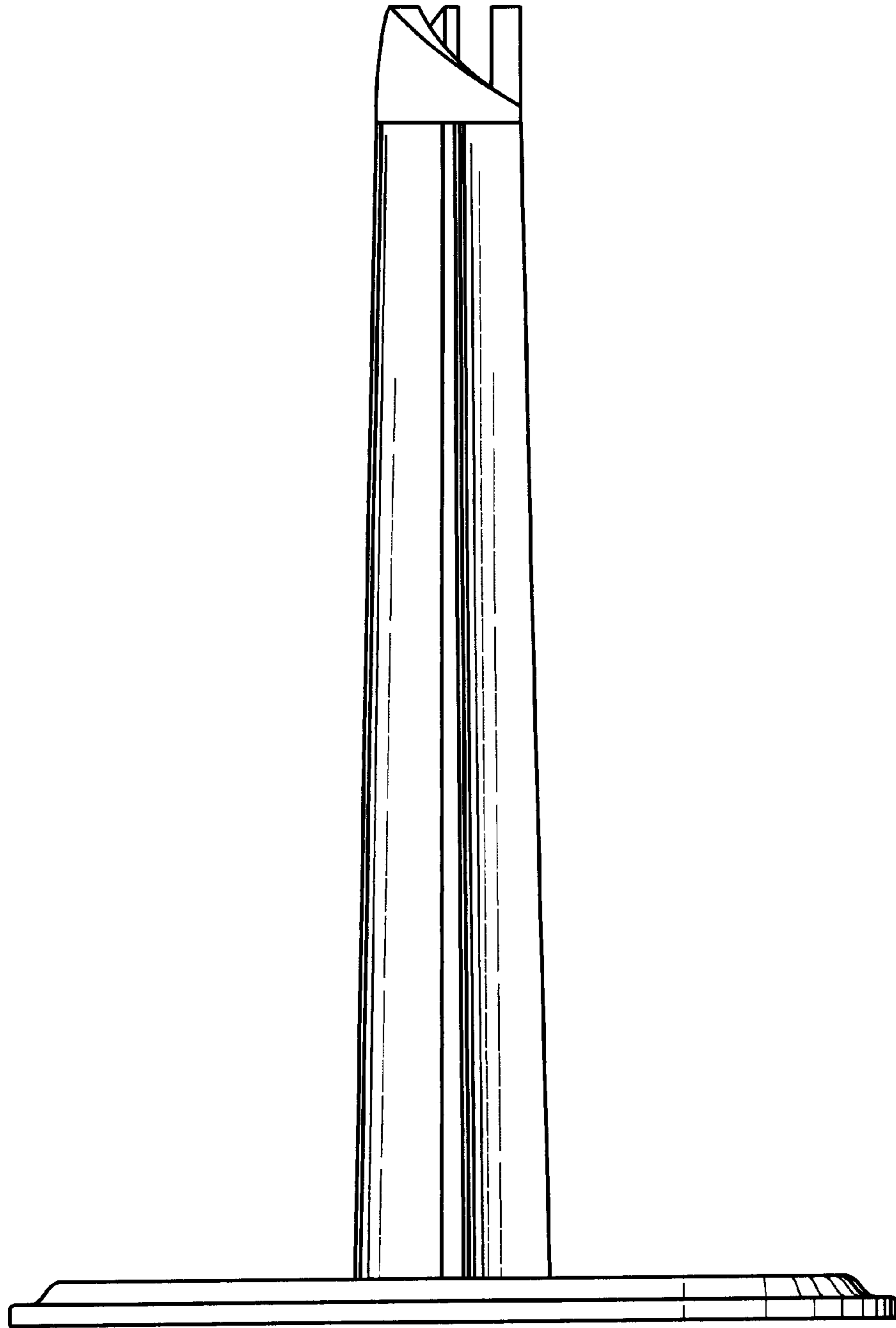

FIG. 3

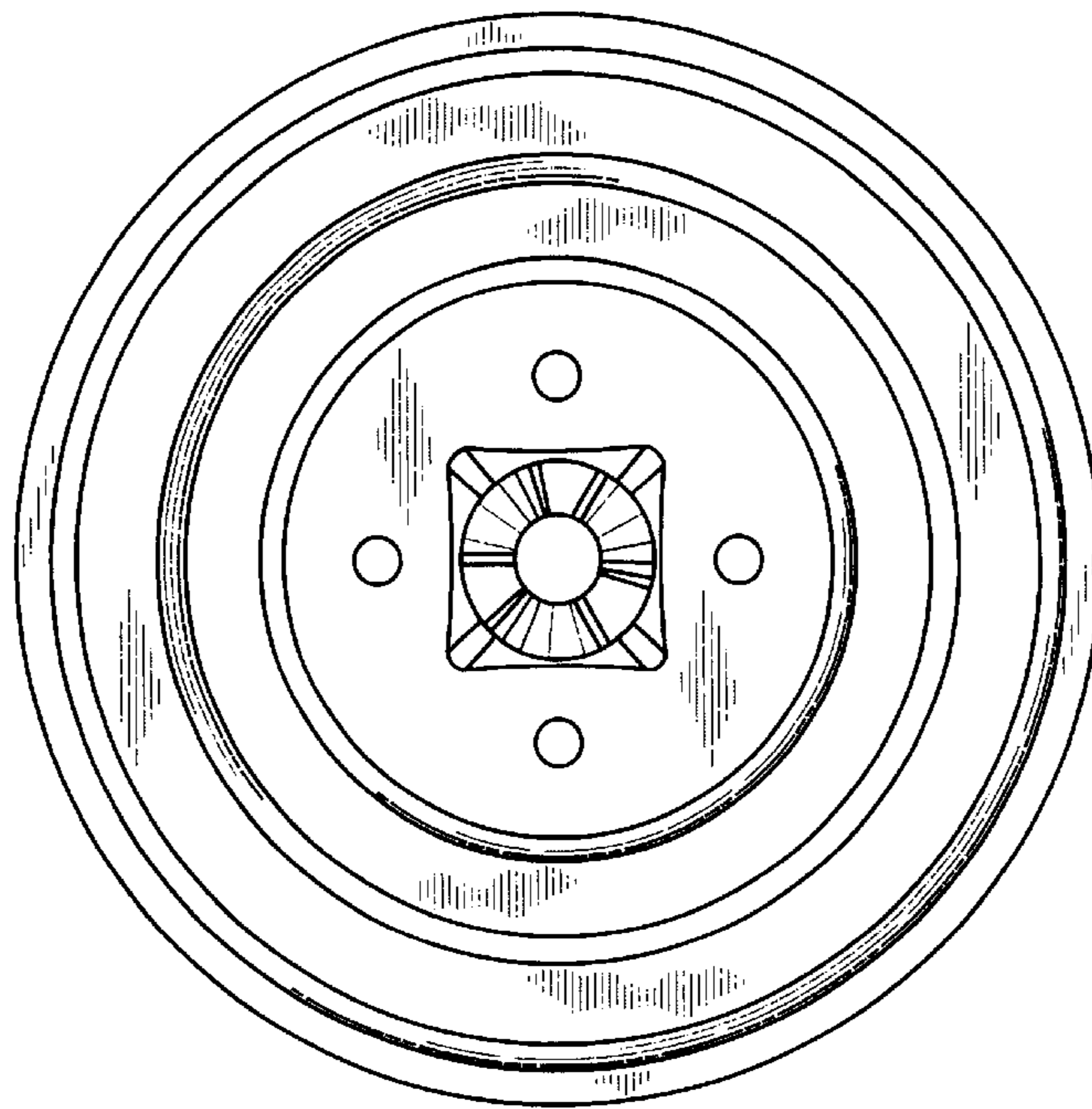

FIG. 4

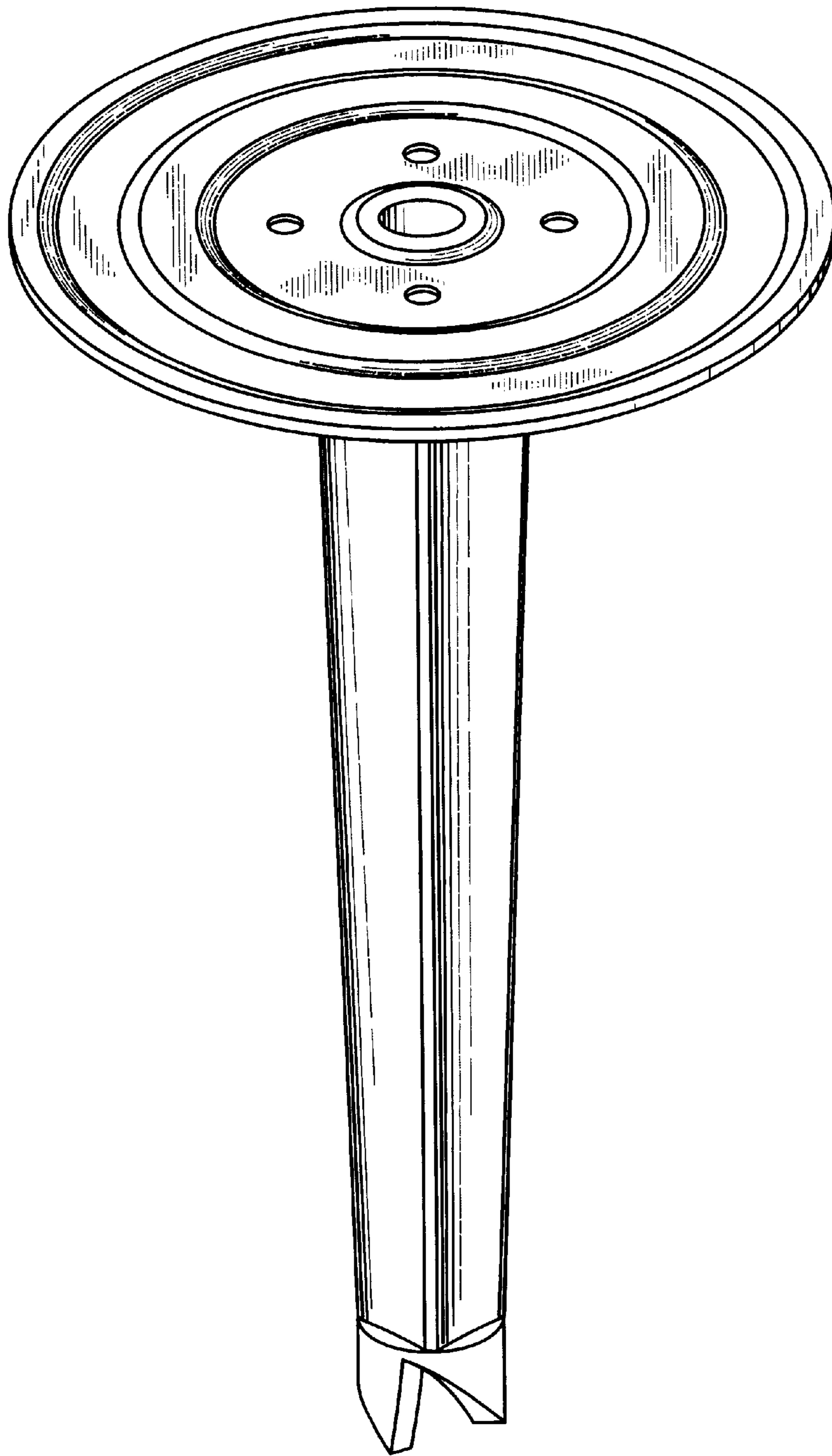

FIG. 5

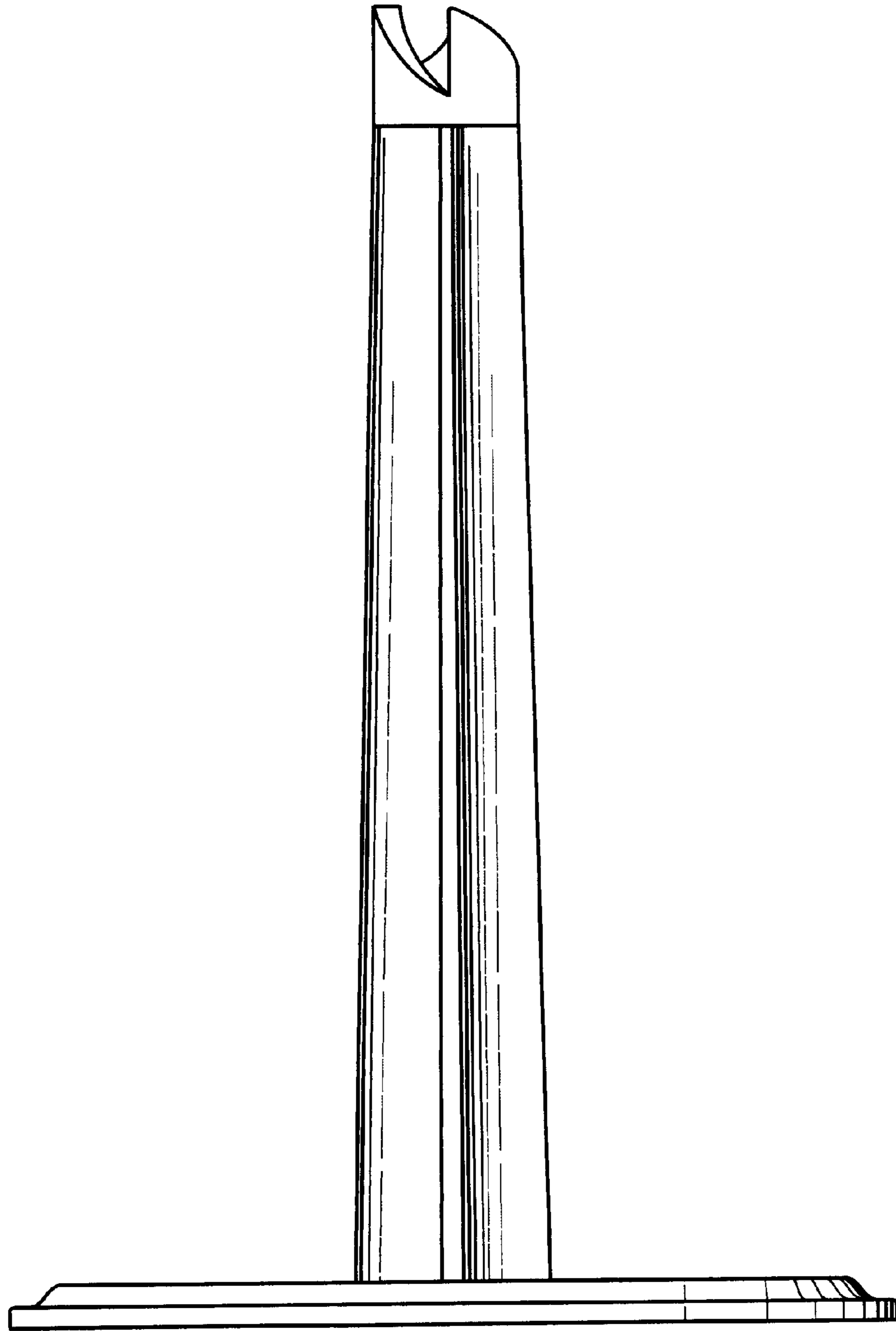

FIG. 6

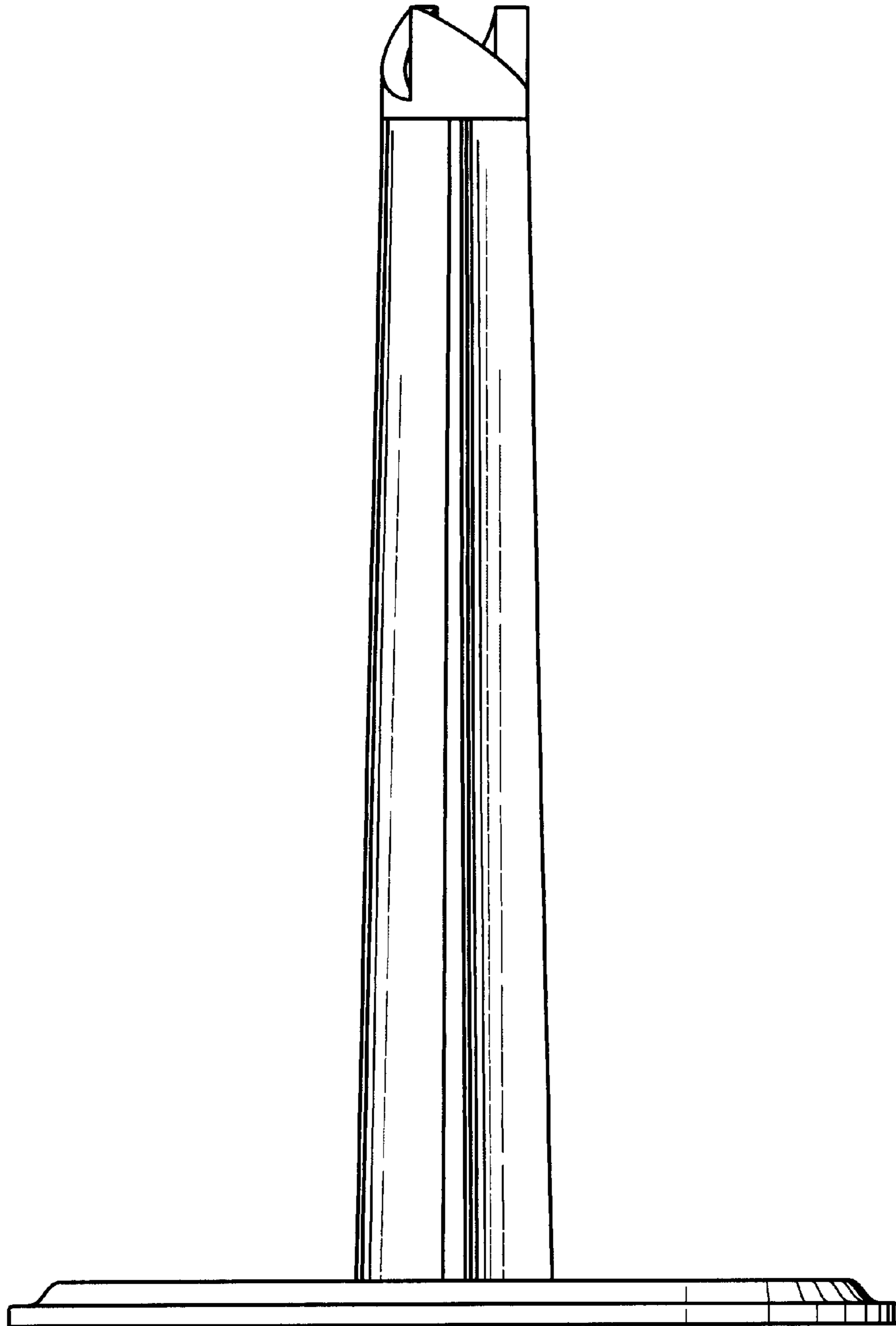

FIG. 7

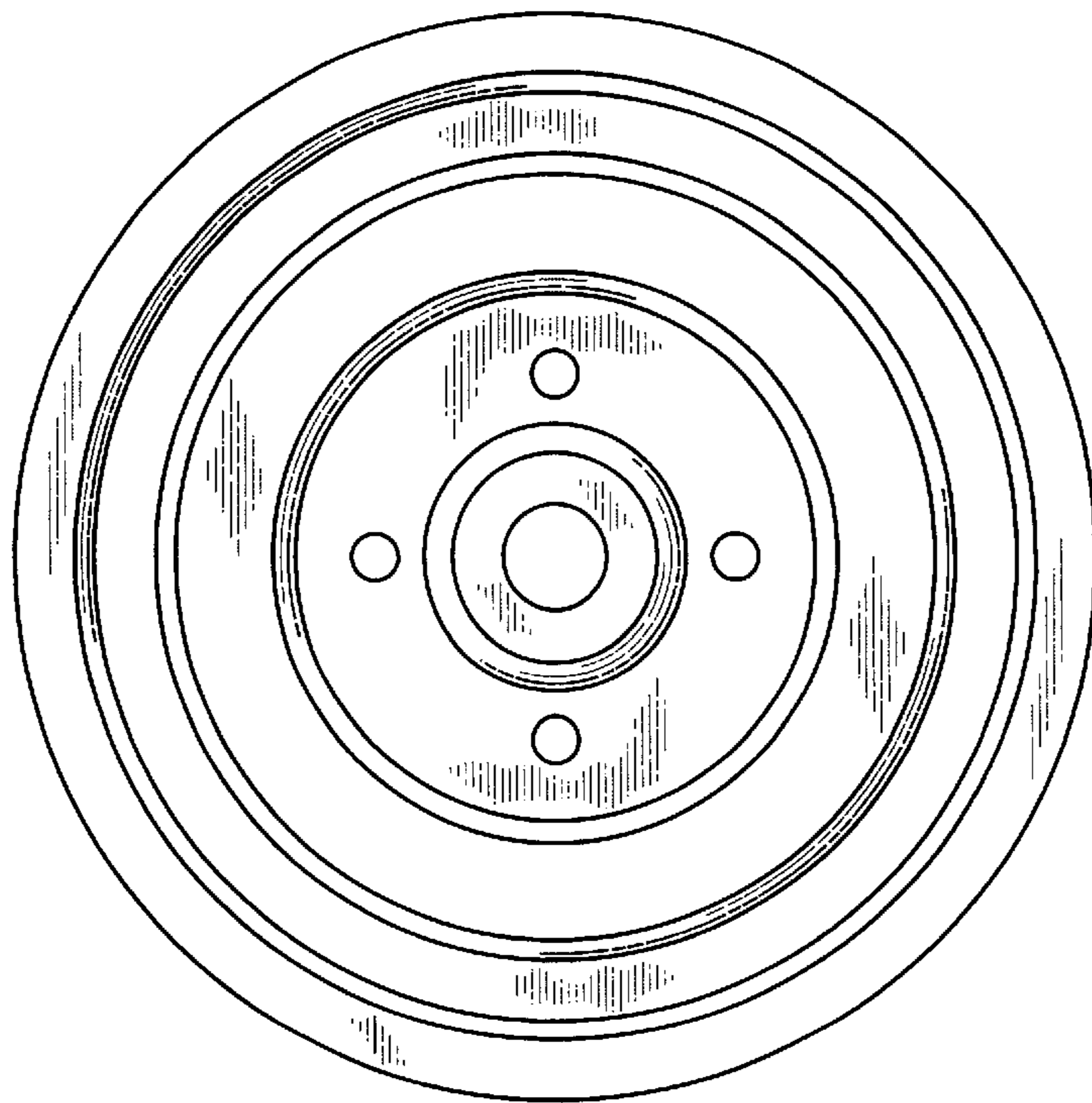

FIG. 8