

US00D518216S

(12) **United States Design Patent**
Rugendyke et al.

(10) **Patent No.:** **US D518,216 S**
(45) **Date of Patent:** **** Mar. 28, 2006**

(54) **FLASHLIGHT**

(75) Inventors: **Timothy Rugendyke**, Lakemba (AU);
John R. Brown, Mosman (AU);
Joseph P. Gardner, North Ridgeville,
OH (US)

(73) Assignee: **Eveready Battery Company, Inc.**, St.
Louis, MO (US)

(**) Term: **14 Years**

(21) Appl. No.: **29/220,943**

(22) Filed: **Jan. 7, 2005**

(30) **Foreign Application Priority Data**

Jul. 8, 2004 (AU) 13216/2004

(51) **LOC (8) Cl.** **26-02**

(52) **U.S. Cl.** **D26/49**

(58) **Field of Classification Search** D26/37-50;
362/157, 158, 171-174, 183-208
See application file for complete search history.

(56) **References Cited**

U.S. PATENT DOCUMENTS

D467,022 S * 12/2002 Fritz D26/49
D493,904 S * 8/2004 Dalton et al. D26/49
D496,116 S * 9/2004 Abernethy et al. D26/49

D498,865 S * 11/2004 Mah D26/49

* cited by examiner

Primary Examiner—Marcus A. Jackson
(74) *Attorney, Agent, or Firm*—Stewart A. Fraser

(57) **CLAIM**

We claim the ornamental design for a flashlight, as shown and described.

DESCRIPTION

FIG. 1 is a view showing the upper front right side perspective of the flashlight of the present invention;
FIG. 2 is a view showing the rear right side perspective of the flashlight of the present invention;
FIG. 3 is a left side view of the flashlight of the present invention;
FIG. 4 is a right side view of the flashlight of the present invention;
FIG. 5 is an underneath view of the flashlight of the present invention;
FIG. 6 is a plan view of the flashlight of the present invention;
FIG. 7 is a view showing the front elevation of the flashlight of the present invention; and,
FIG. 8 is a view showing the rear elevation of the flashlight of the present invention.

1 Claim, 5 Drawing Sheets

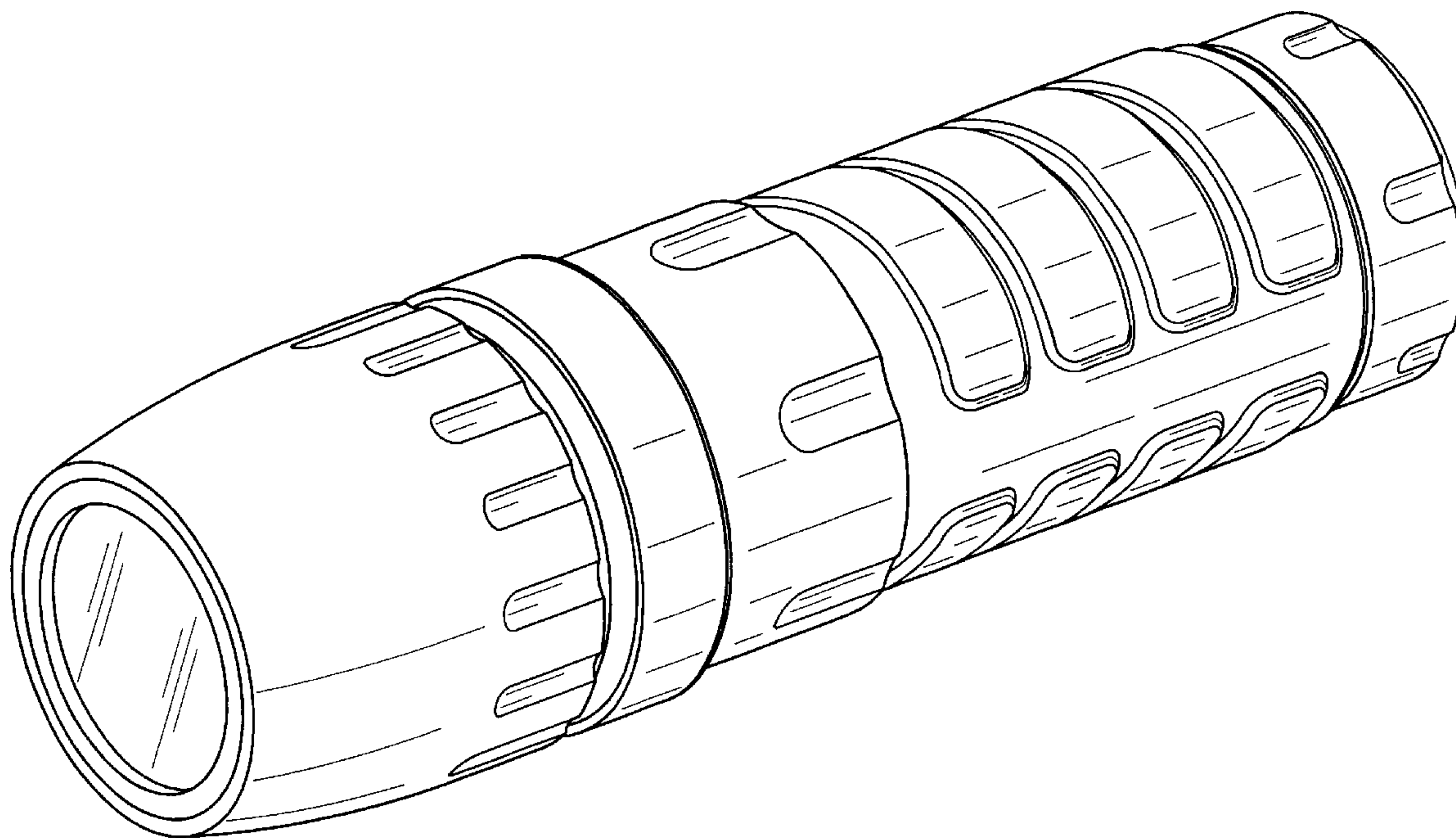

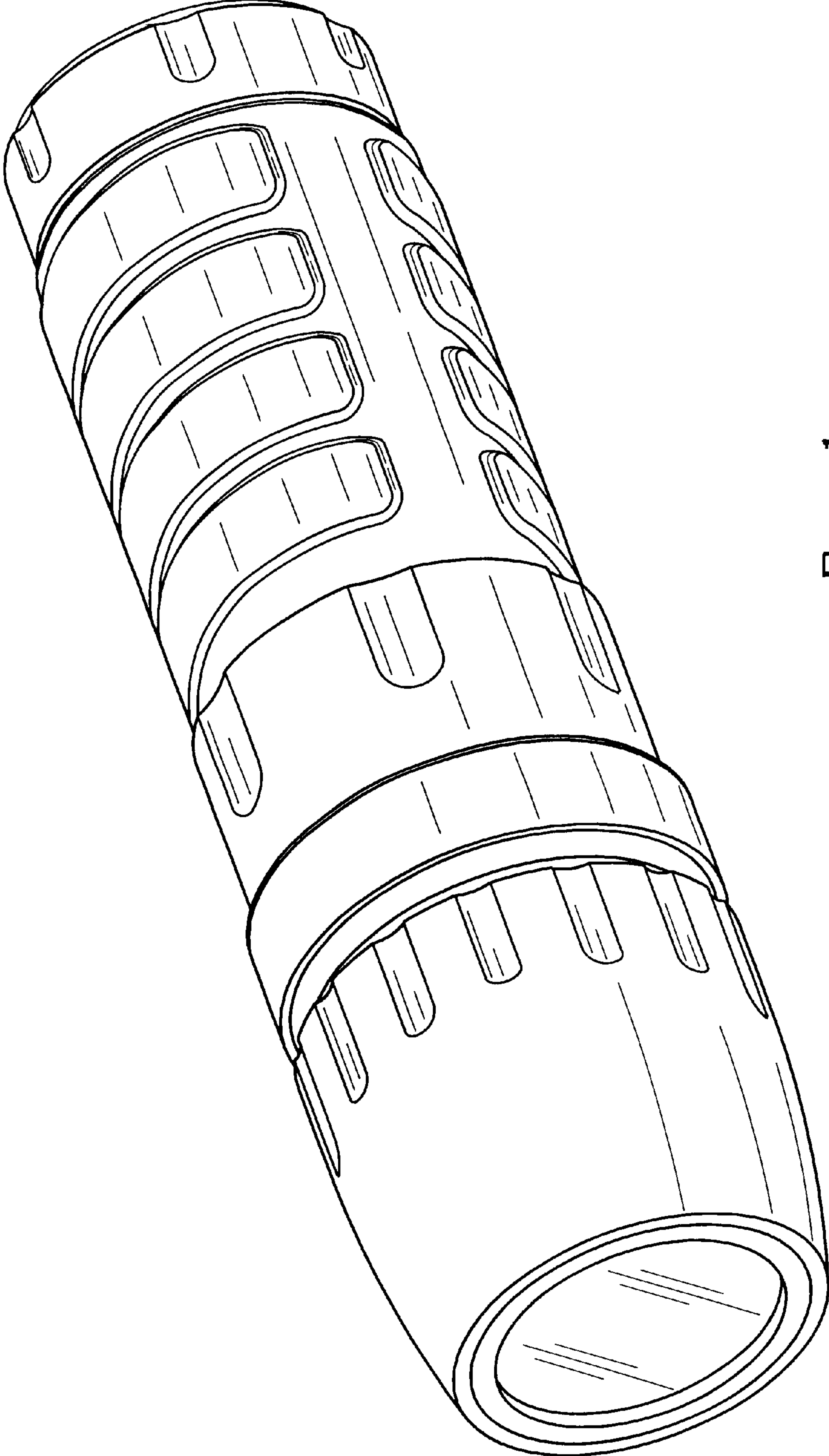

Fig. 1

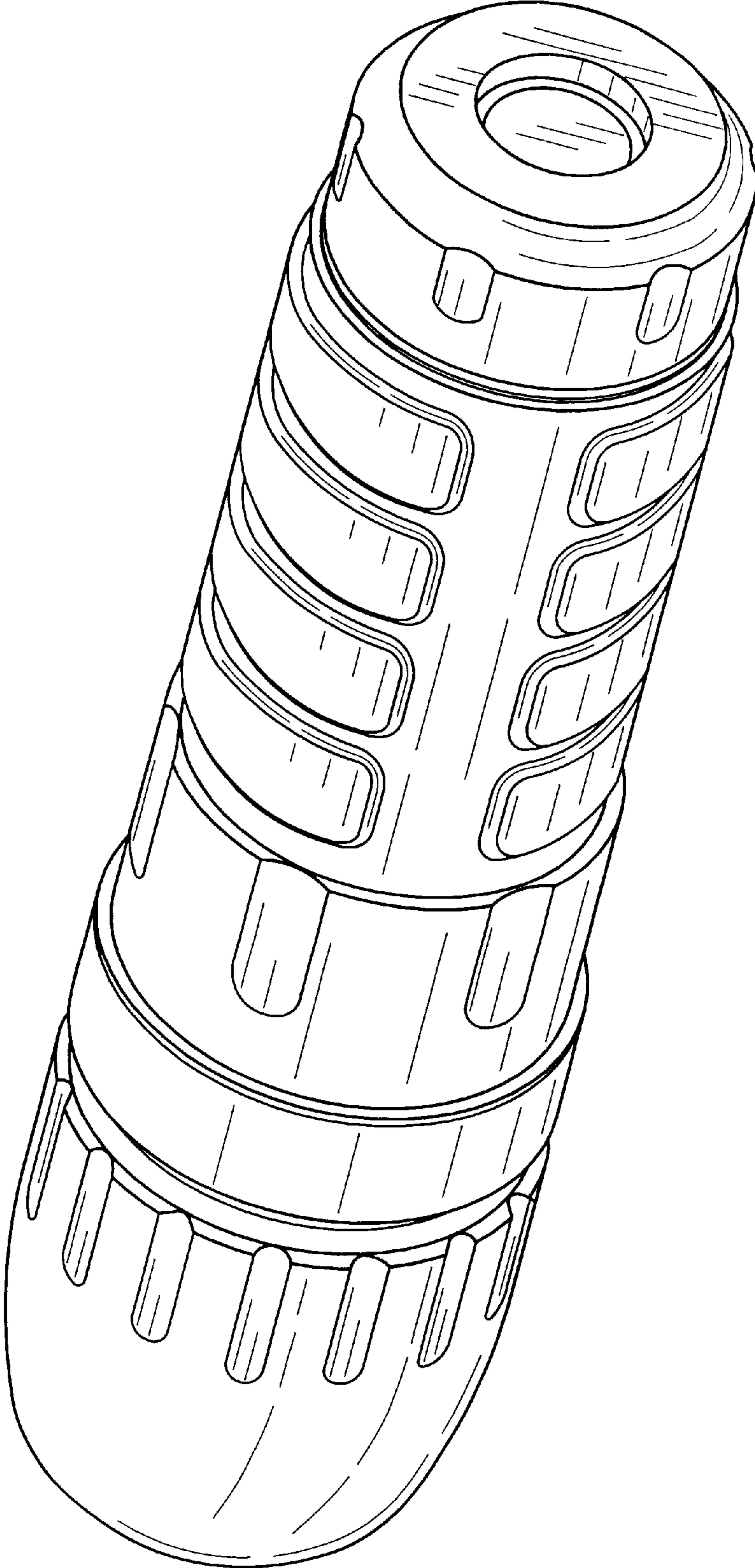

Fig. 2

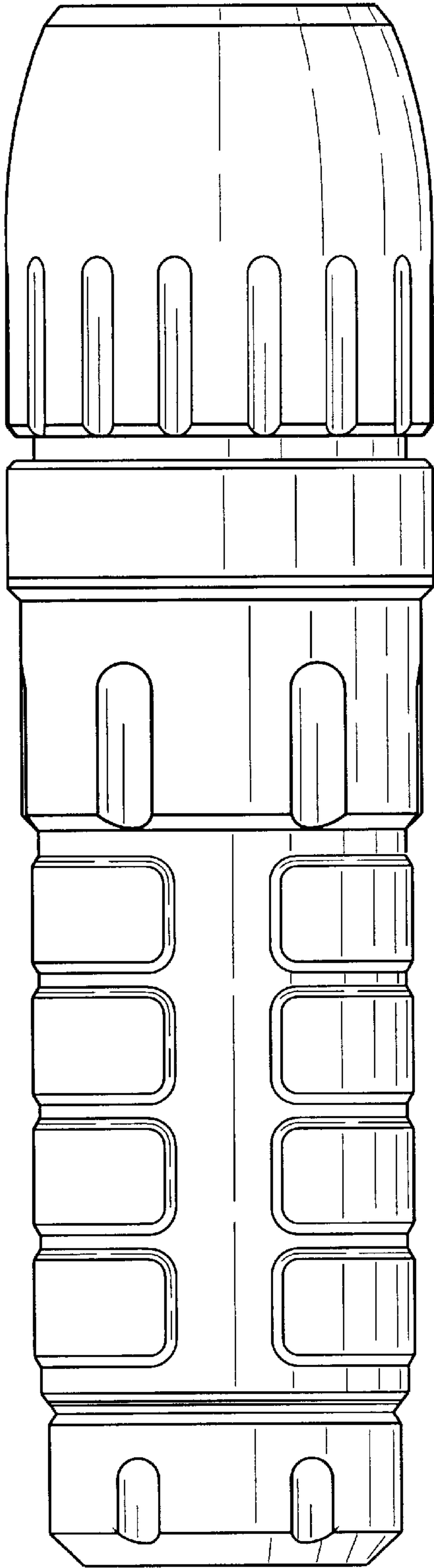

Fig. 3

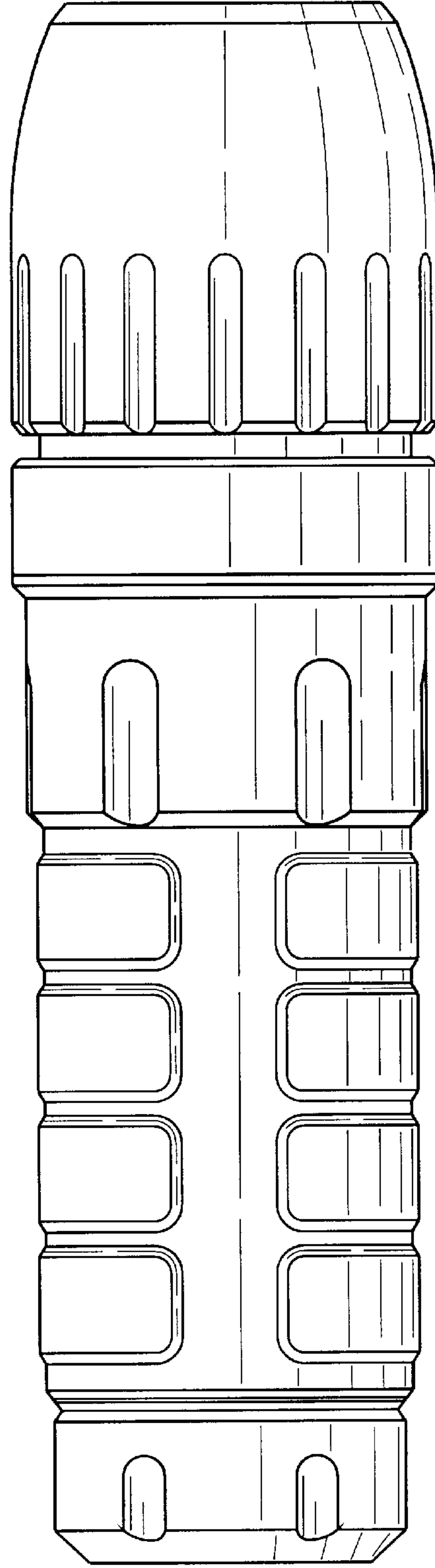

Fig. 4

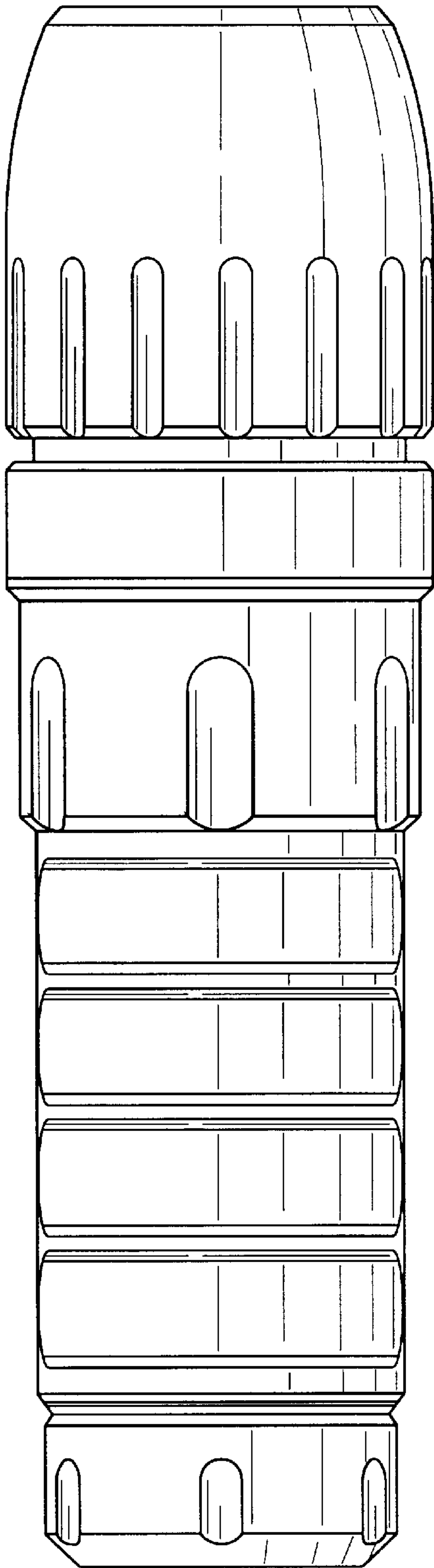

Fig. 5

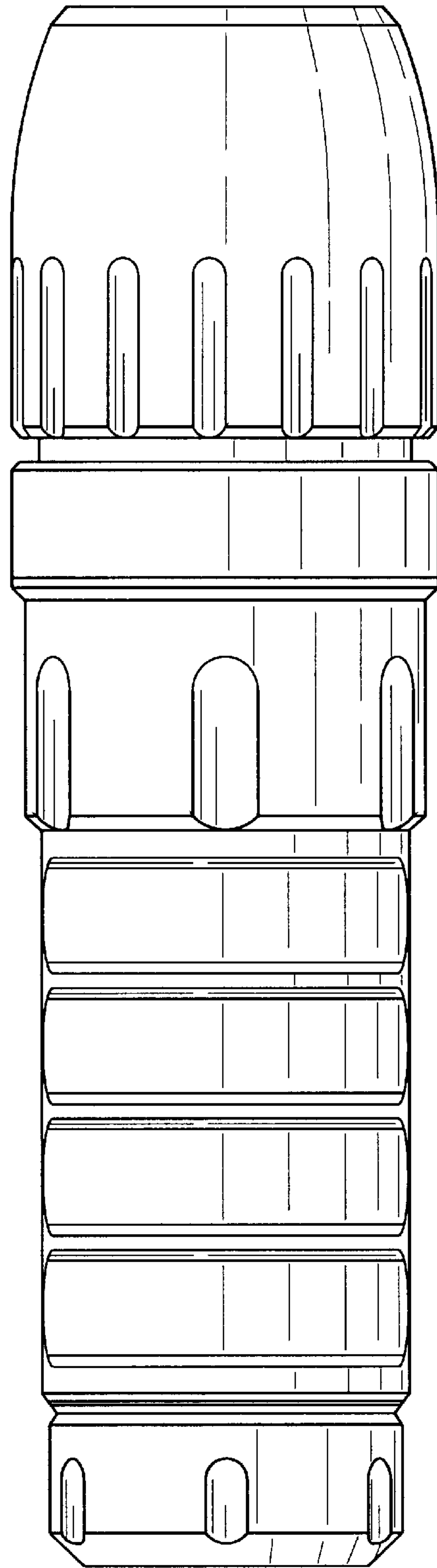

Fig. 6

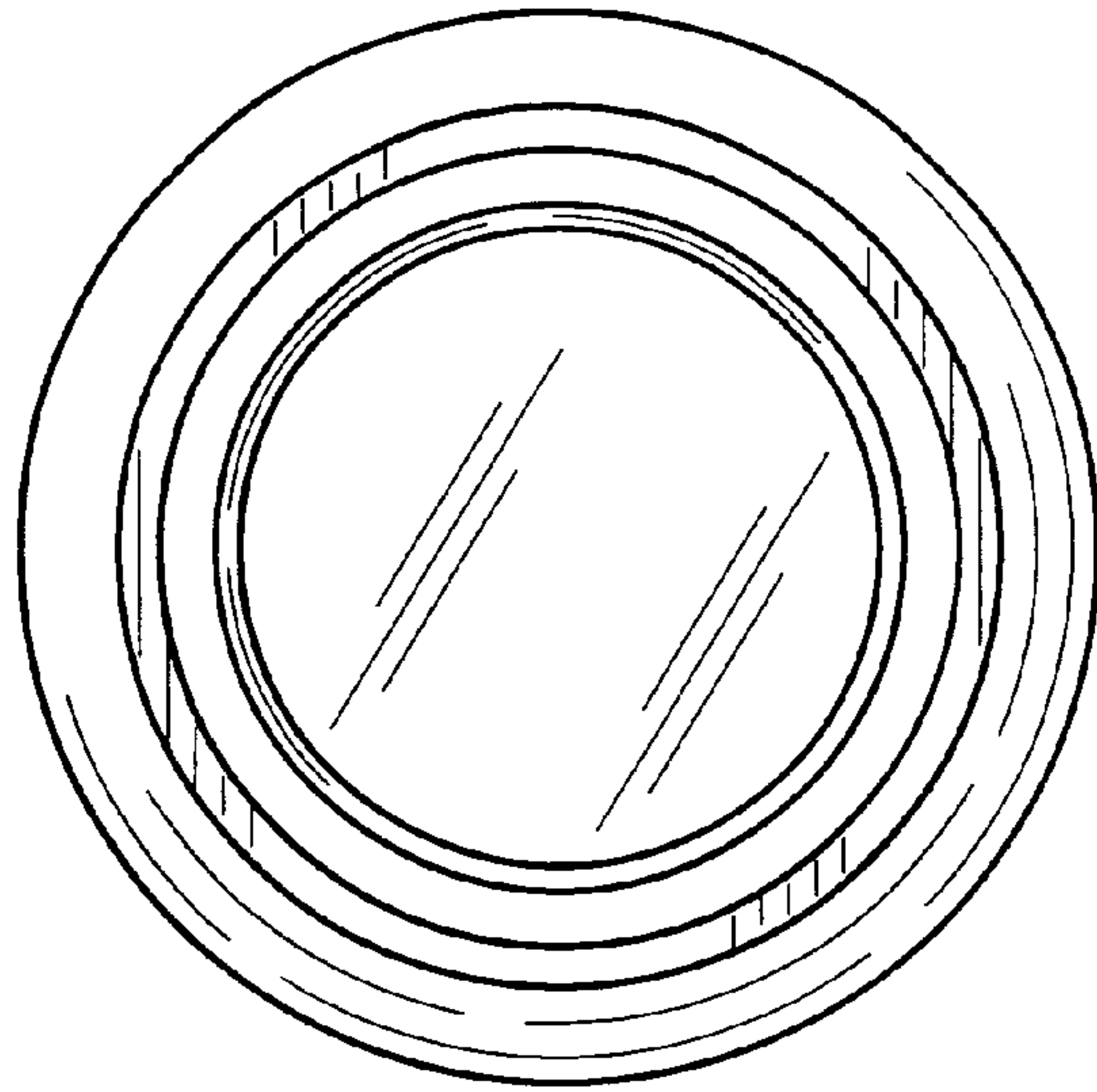

Fig. 7

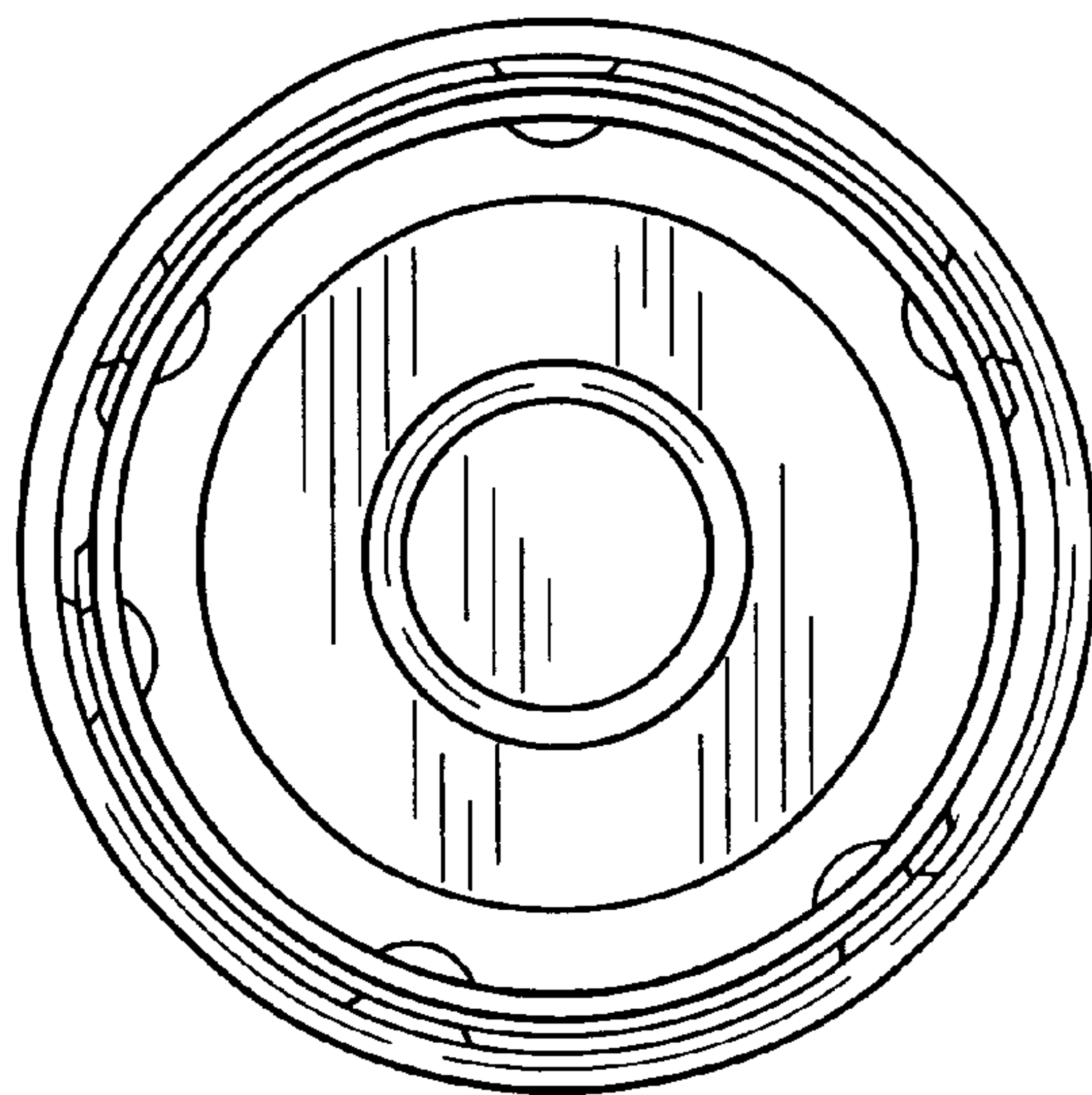

Fig. 8