



US00D518213S

(12) **United States Design Patent**
Ping

(10) **Patent No.:** **US D518,213 S**

(45) **Date of Patent:** **** Mar. 28, 2006**

(54) **SWIVEL FLASHLIGHT**

FOREIGN PATENT DOCUMENTS

(75) Inventor: **Qiu Jian Ping**, Hangzhou (CN)

DE 327882 10/1920
DE 522078 3/1931

(73) Assignee: **Great Neck Saw Manufacturers, Inc.**,
Mineola, NY (US)

Primary Examiner—Marcus A. Jackson
(74) *Attorney, Agent, or Firm*—Joseph J. Previto

(**) Term: **14 Years**

(57) **CLAIM**

The ornamental design of a swivel flashlight, as shown and described.

(21) Appl. No.: **29/191,791**

(22) Filed: **Oct. 14, 2003**

DESCRIPTION

(51) **LOC (8) Cl.** **26-02**

(52) **U.S. Cl.** **D26/44**

(58) **Field of Classification Search** D26/37–50;
362/157, 158, 171–174, 183–208
See application file for complete search history.

FIG. 1 is a perspective view of my new design.
FIG. 2 is a top end view thereof.
FIG. 3 is a front view thereof.
FIG. 4 is a side view thereof.
FIG. 5 is a rear view thereof.
FIG. 6 is another side view thereof.
FIG. 7 is a bottom end view thereof.
FIG. 8 is a perspective view similar to FIG. 1 showing the head in a folded position.
FIG. 9 is a top view thereof.
FIG. 10 is a front view thereof.
FIG. 11 is a side view thereof.
FIG. 12 is a rear view thereof.
FIG. 13 is a side view thereof.
FIG. 14 is a bottom end view thereof.
FIG. 15 is a perspective view of another embodiment of the present invention.
FIG. 16 is a top view thereof.
FIG. 17 is a front view thereof.
FIG. 18 is a side view thereof.
FIG. 19 is a rear view thereof.
FIG. 20 is another side view thereof.
FIG. 21 is a bottom end view thereof.
FIG. 22 is a perspective view similar to FIG. 15 showing the head in a folded position.
FIG. 23 is a top end view thereof.
FIG. 24 is a front view thereof.
FIG. 25 is a side view thereof.
FIG. 26 is a rear view thereof.
FIG. 27 is another side view thereof; and,
FIG. 28 is a bottom end view thereof.

(56) **References Cited**

U.S. PATENT DOCUMENTS

699,546 A	5/1902	Merritt
1,689,382 A	10/1928	Eaton
1,699,927 A	1/1929	Stearns
1,807,129 A	5/1931	Nuckolls
1,863,151 A	6/1932	Barber
1,899,868 A	2/1933	Herlbauer
2,040,423 A	5/1936	Barber
D113,400 S	2/1939	Ritter
2,205,163 A	6/1940	Blau
2,401,366 A	6/1946	Muldoon
2,539,974 A	1/1951	Riddell
2,796,516 A	6/1957	Martschik
4,196,821 A	4/1980	Teti, Jr.
4,432,042 A	2/1984	Zeller
4,447,863 A	5/1984	Fenne
4,464,707 A	8/1984	Forrest
4,466,664 A	8/1984	Kondou
4,495,550 A	1/1985	Visciano
4,533,982 A	8/1985	Kozar
4,586,113 A	4/1986	Tsuyama
4,706,331 A	11/1987	Compton
4,739,457 A	4/1988	Orr

(Continued)

1 Claim, 12 Drawing Sheets

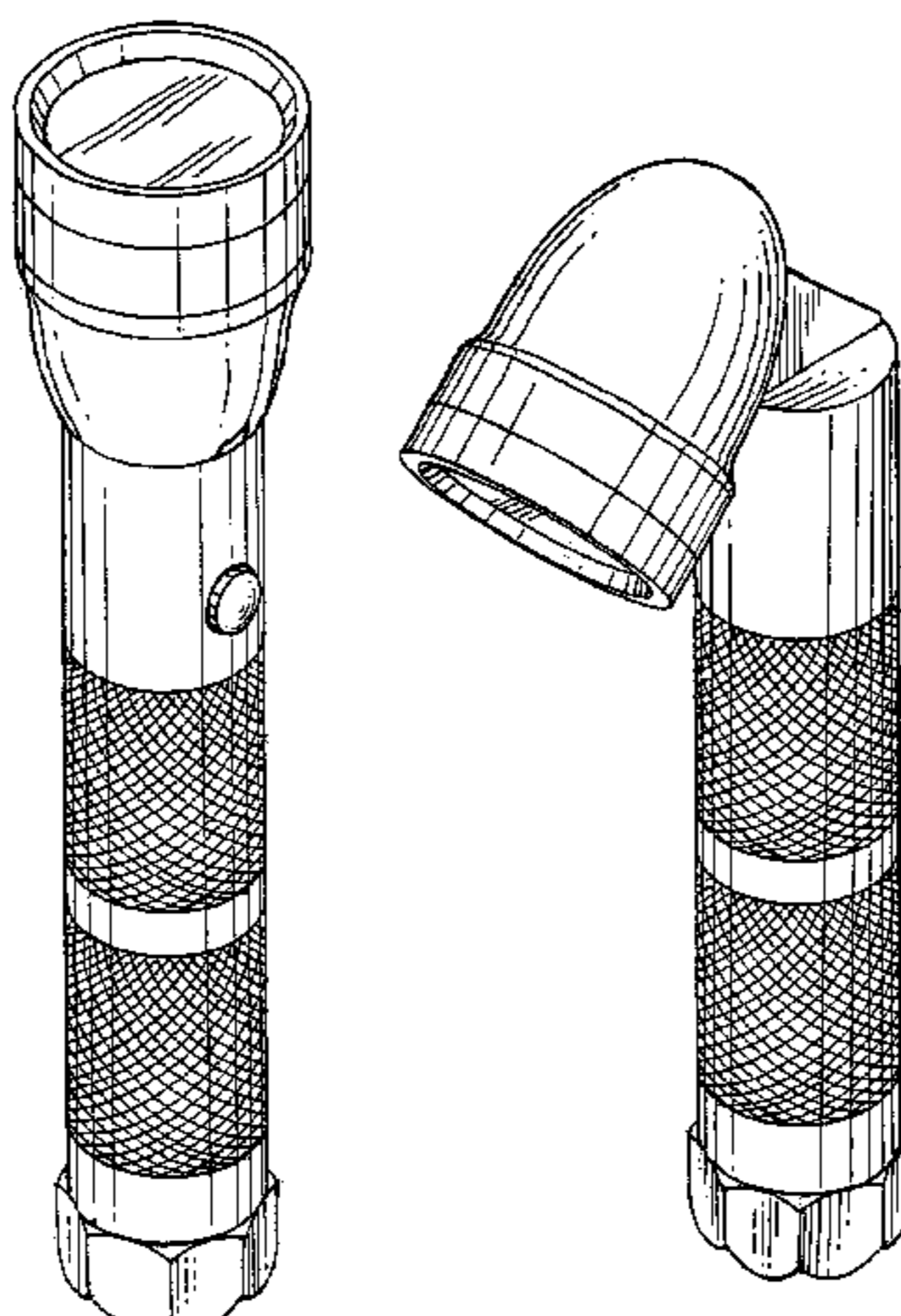

US D518,213 S

Page 2

U.S. PATENT DOCUMENTS							
4,782,435	A	11/1988	Manzoni	D404,839	S * 1/1999	Petterson et al. D26/44	
4,937,713	A	6/1990	Holt et al.	5,988,828	A	11/1999	Prince et al.
4,949,928	A	8/1990	Hoshino	5,993,022	A	11/1999	Neyer et al.
4,974,130	A	11/1990	Friedman	6,012,824	A	1/2000	Sharrah et al.
5,119,280	A	6/1992	Yang	D444,582	S * 7/2001	Poon D26/44	
5,355,746	A	10/1994	Lin	D445,925	S	7/2001	Parker
5,410,457	A	4/1995	Parker	6,457,841	B1	10/2002	Lynch et al.
D360,702	S *	7/1995	Bamber D26/44	D468,850	S	1/2003	Sharrah et al.
5,541,822	A	7/1996	Bamber	D476,437	S	6/2003	Dalton et al.
D390,986	S *	2/1998	Yuen D26/44	D477,102	S	7/2003	Yuen

* cited by examiner

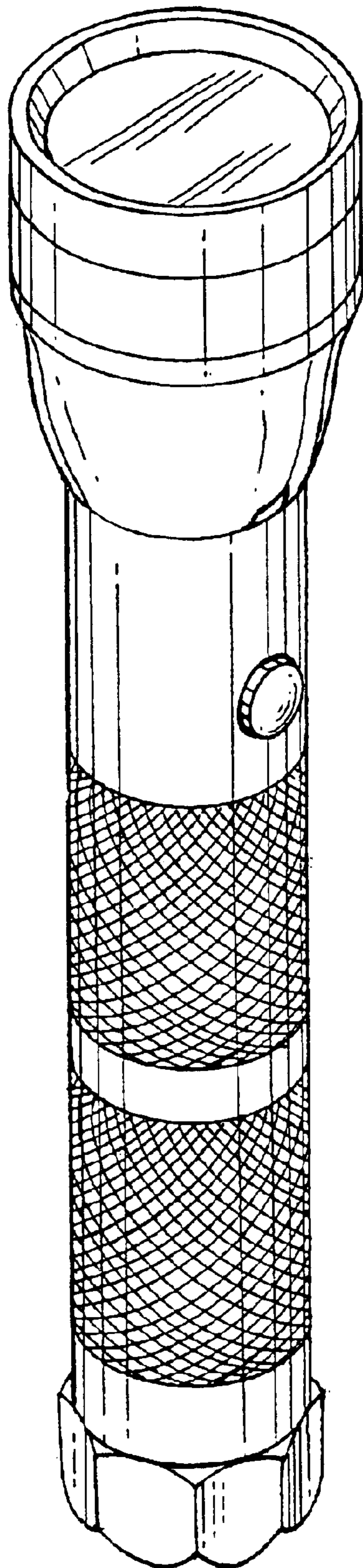

FIG. 1

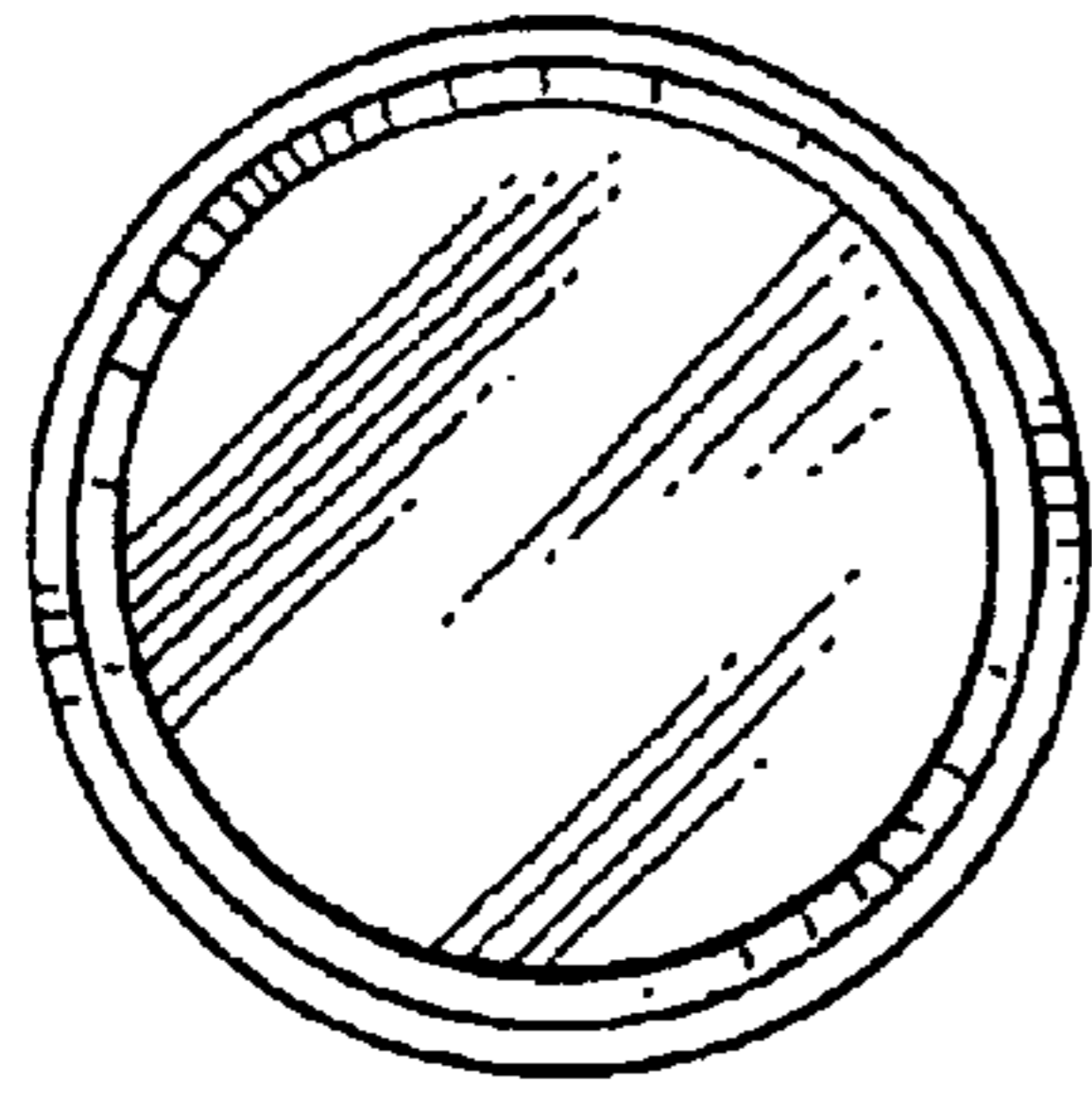

FIG. 2

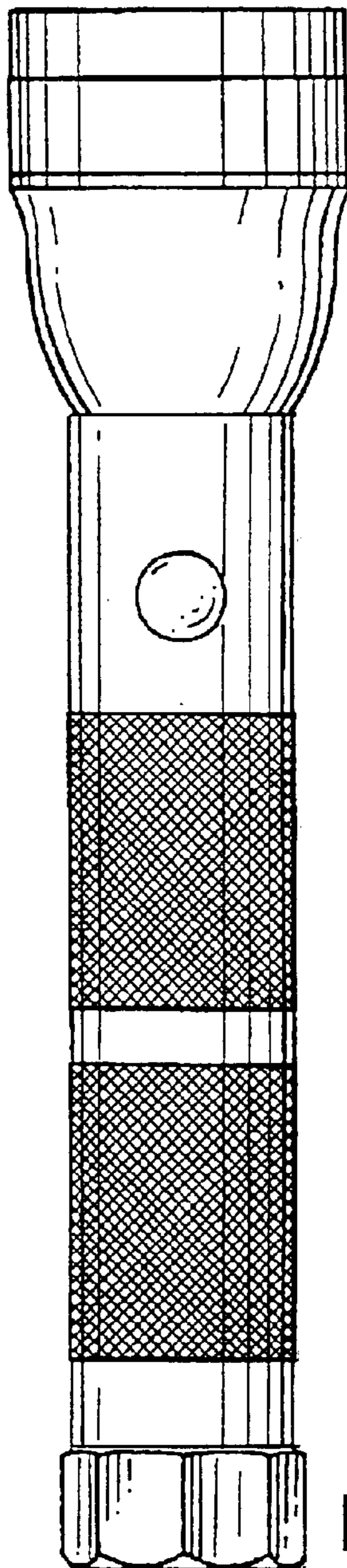

FIG. 3

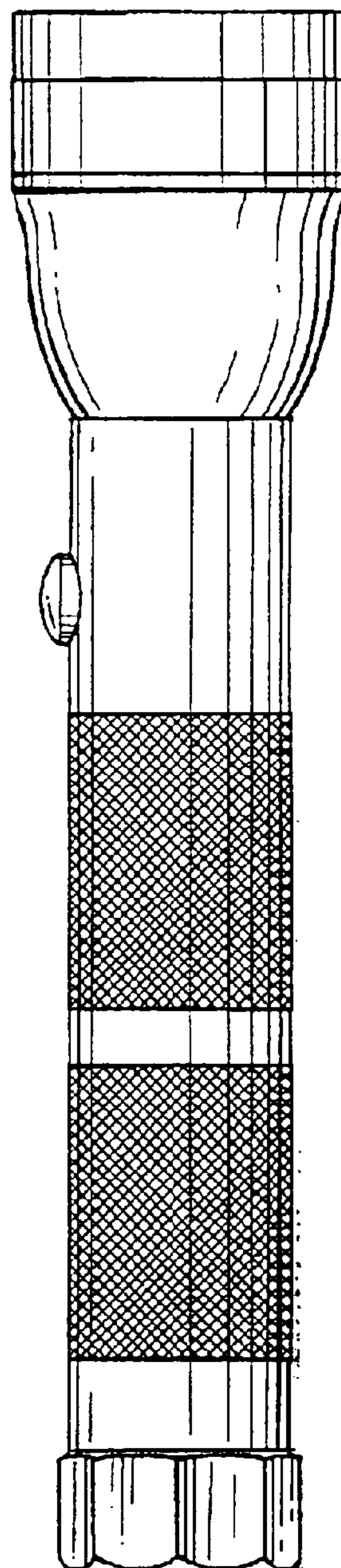

FIG. 4

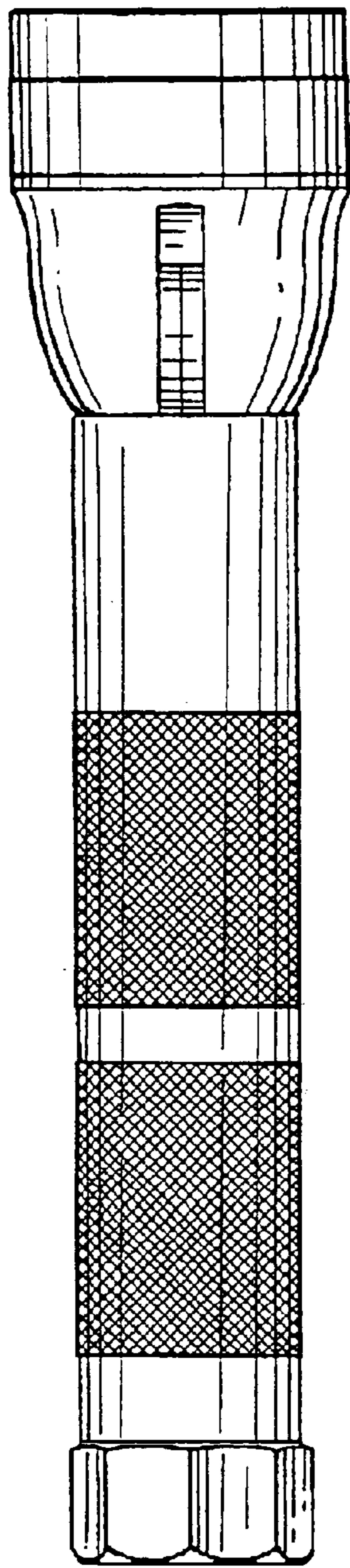

FIG. 5

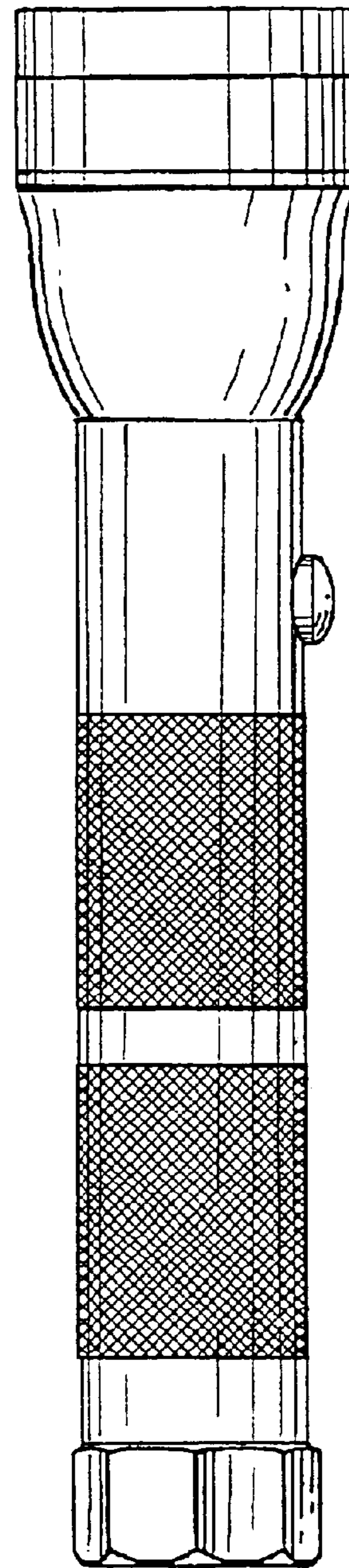

FIG. 6

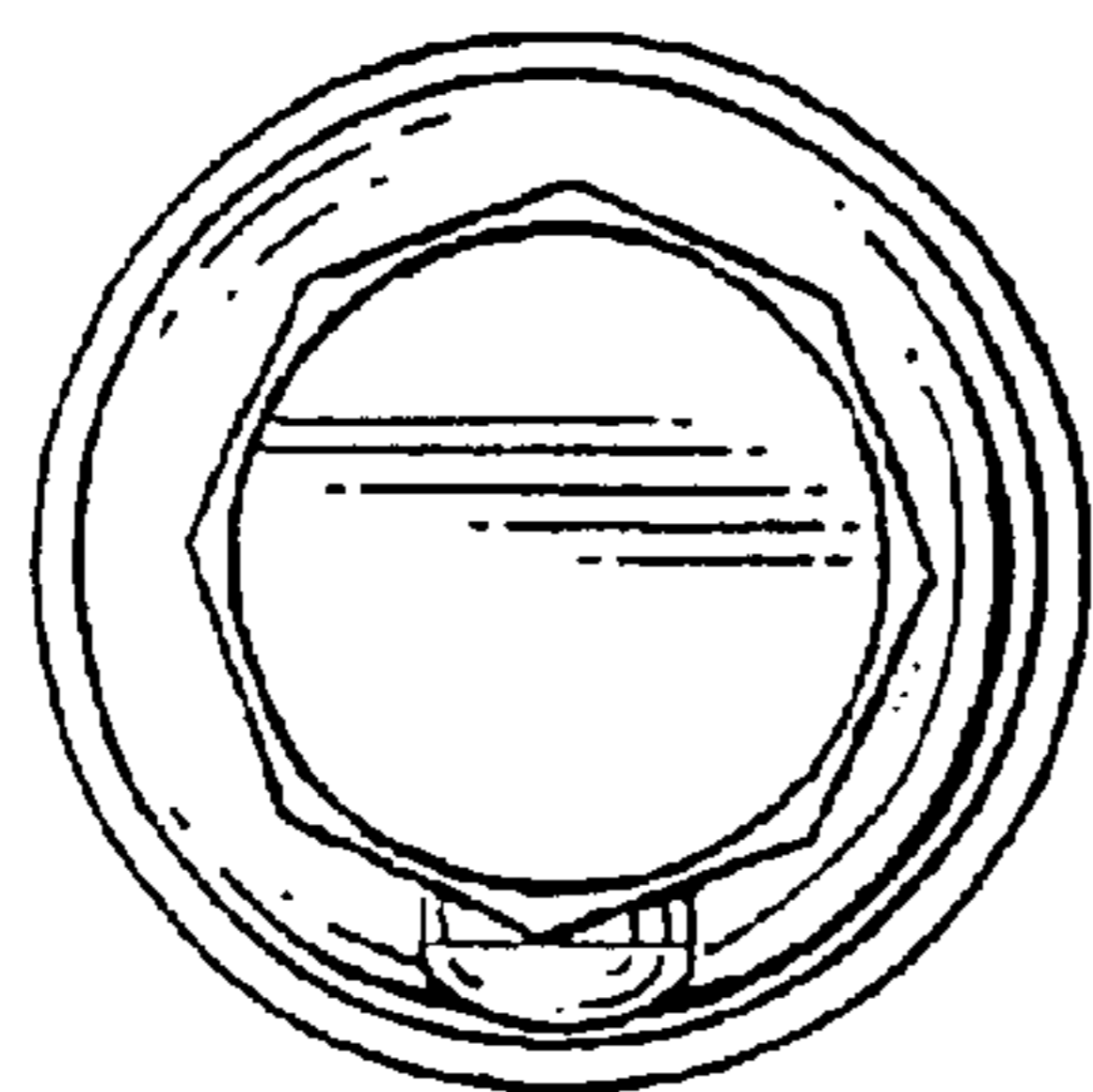

FIG. 7

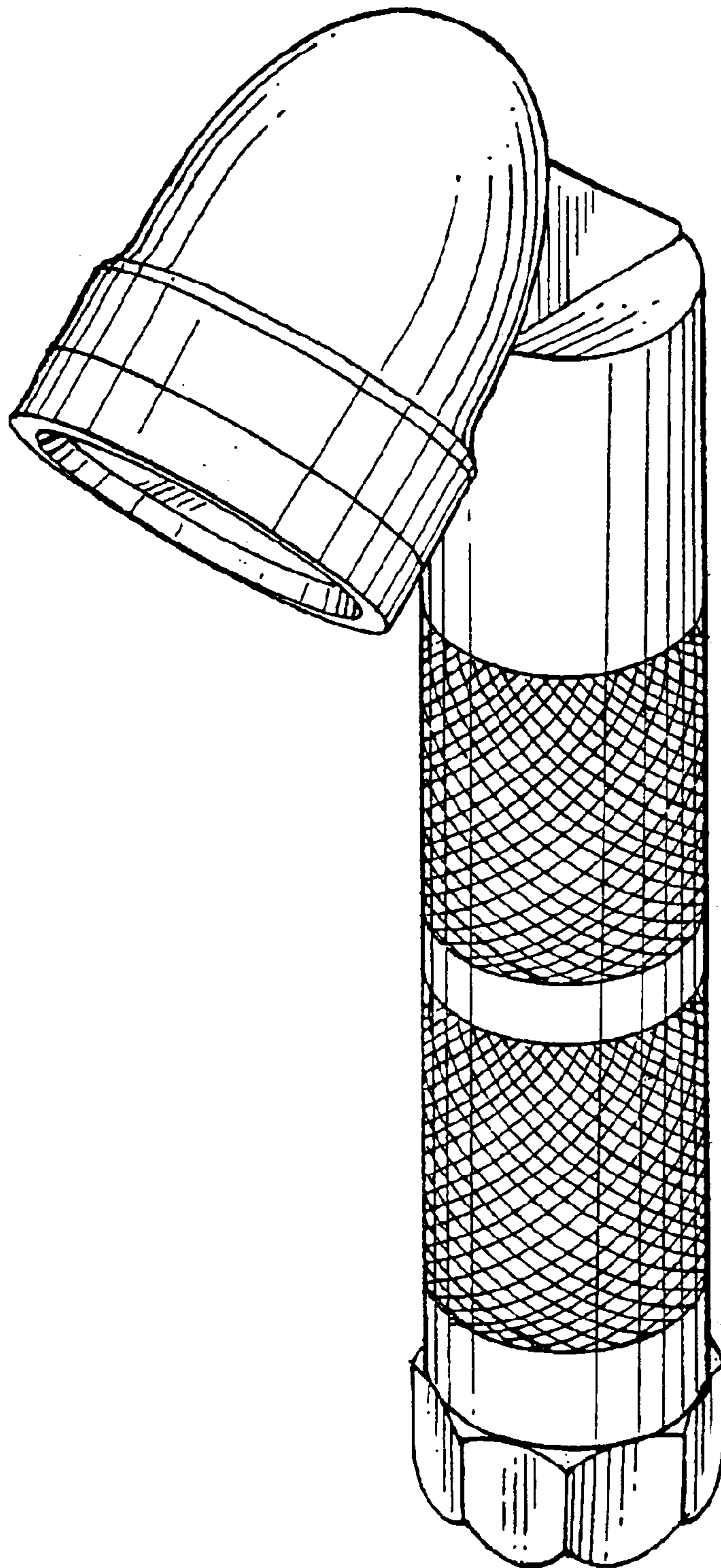

FIG.8

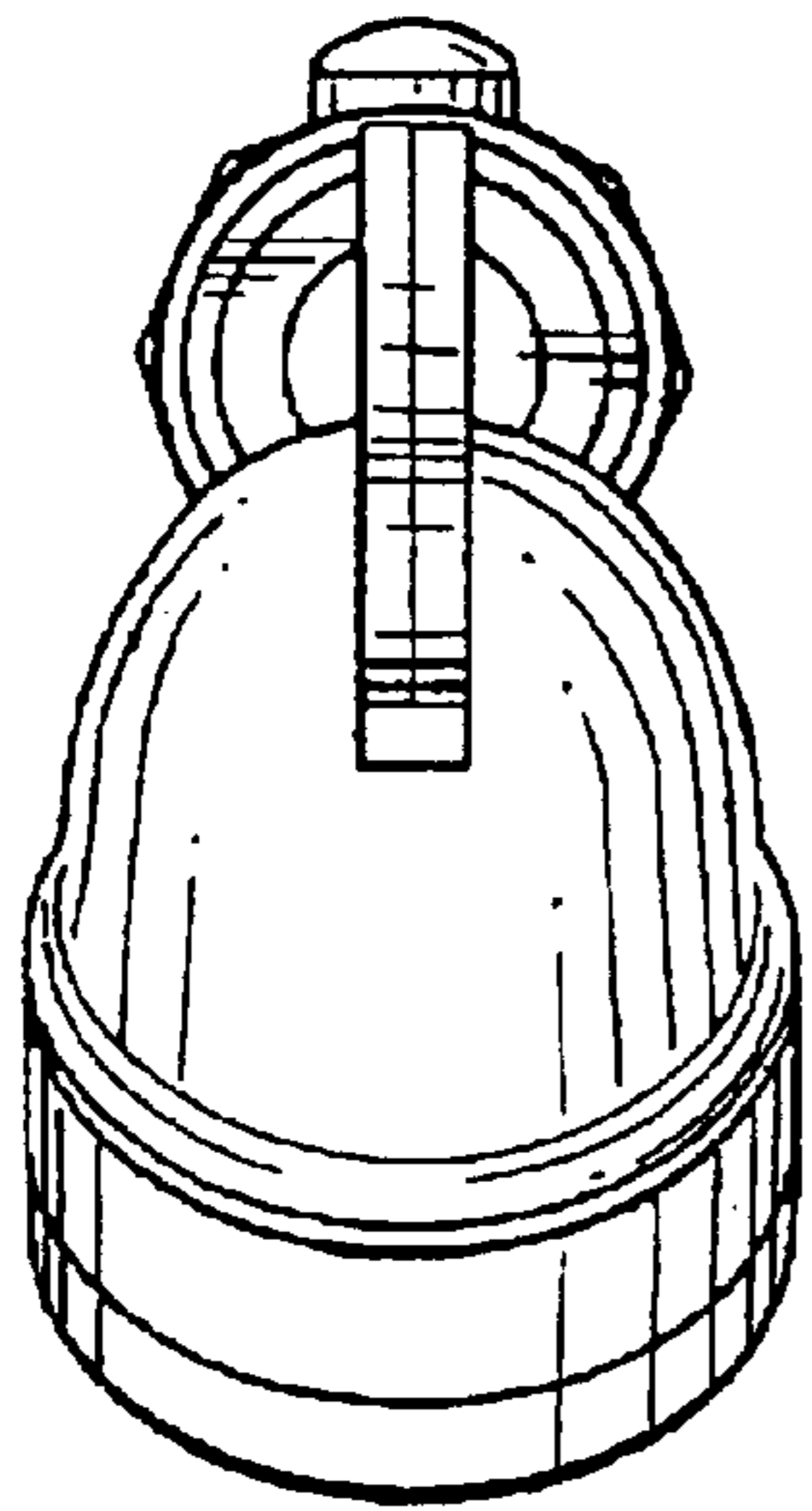

FIG. 9

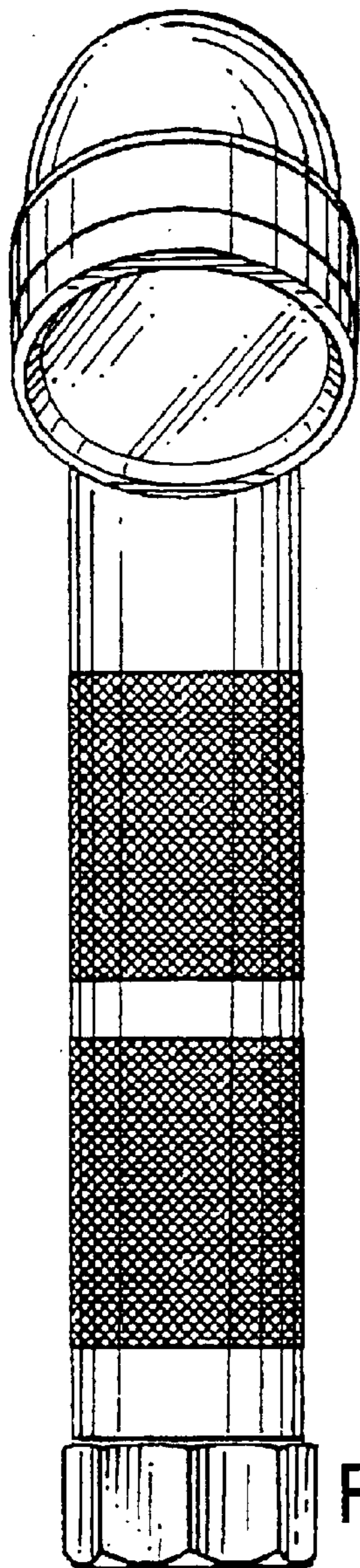

FIG. 10

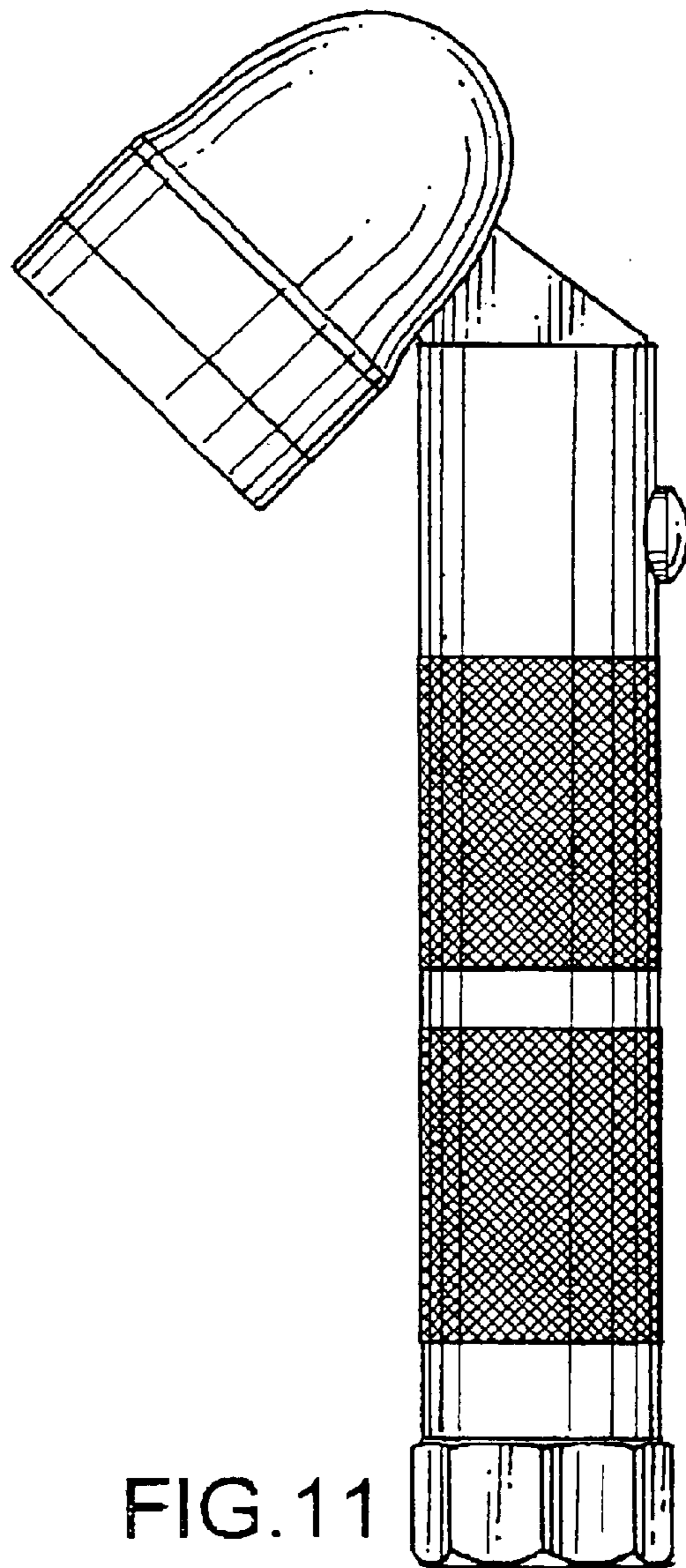

FIG. 11

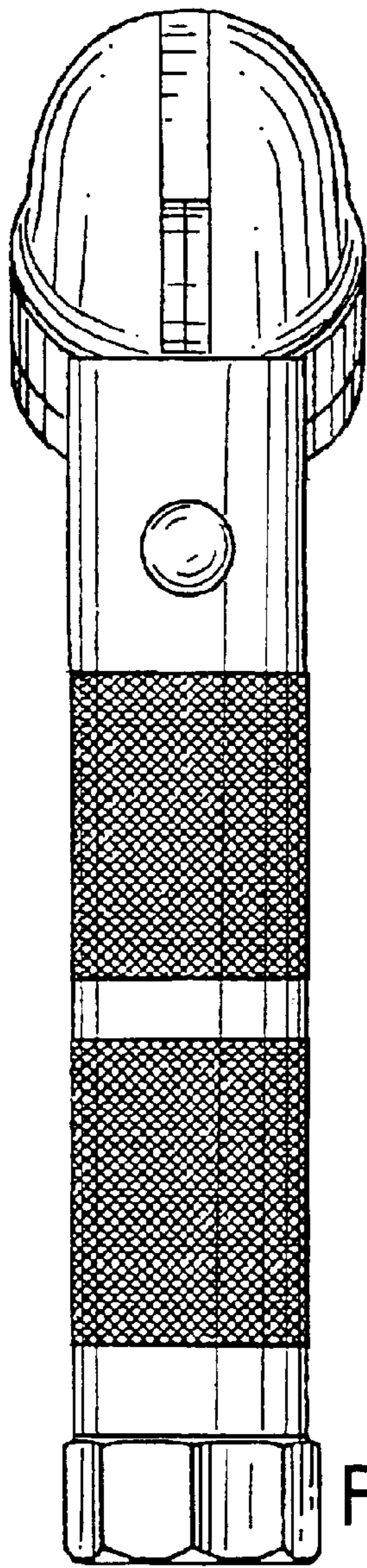

FIG. 12

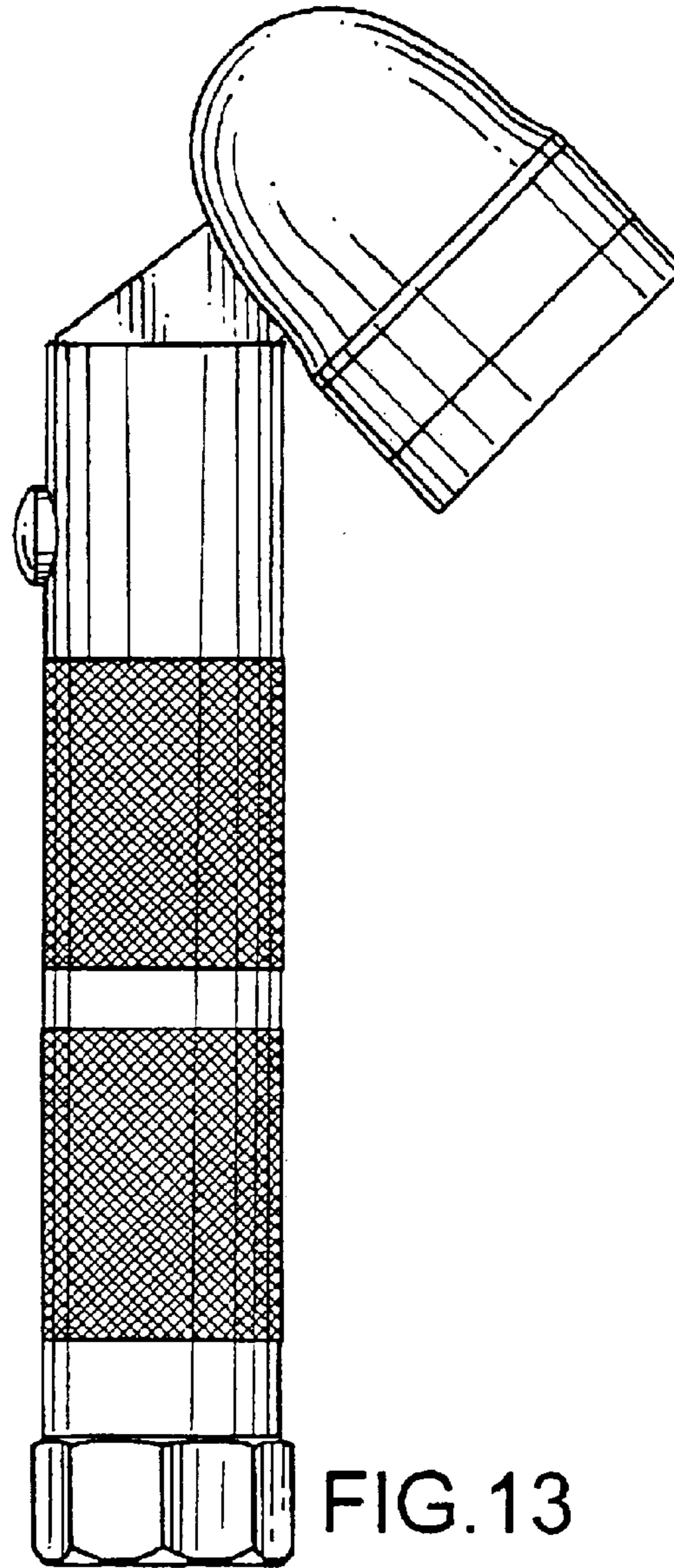

FIG. 13

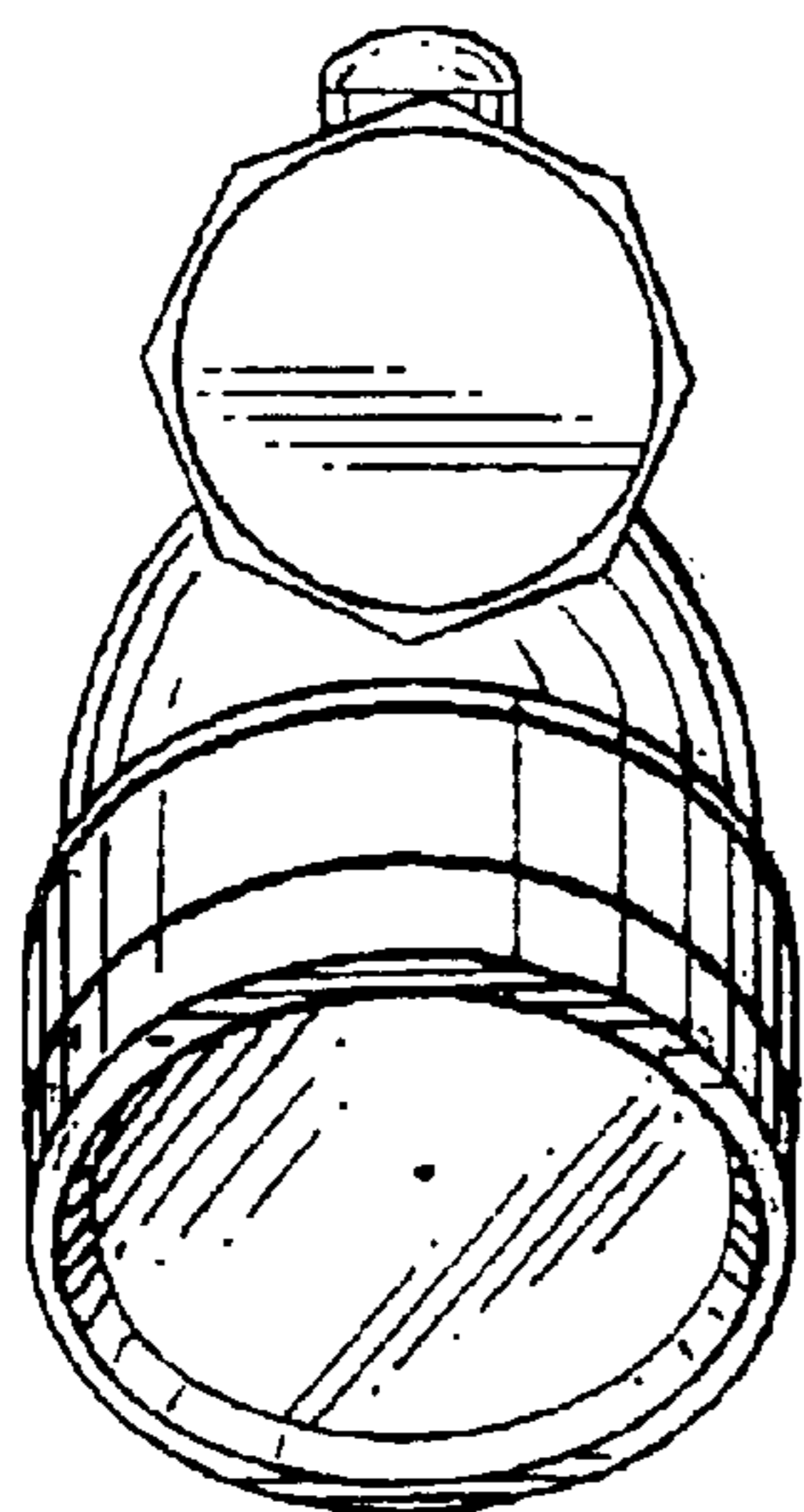

FIG. 14

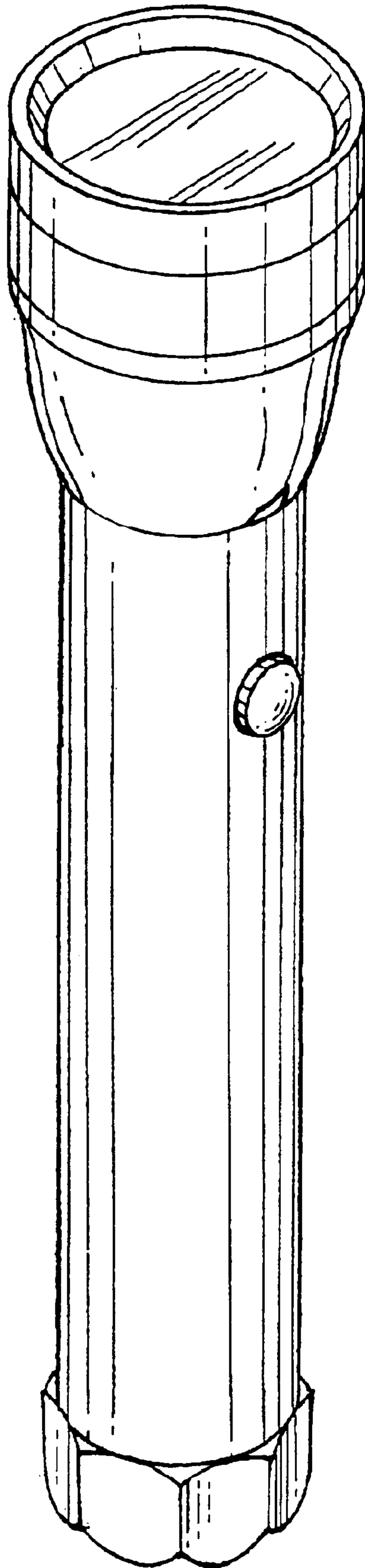

FIG.15

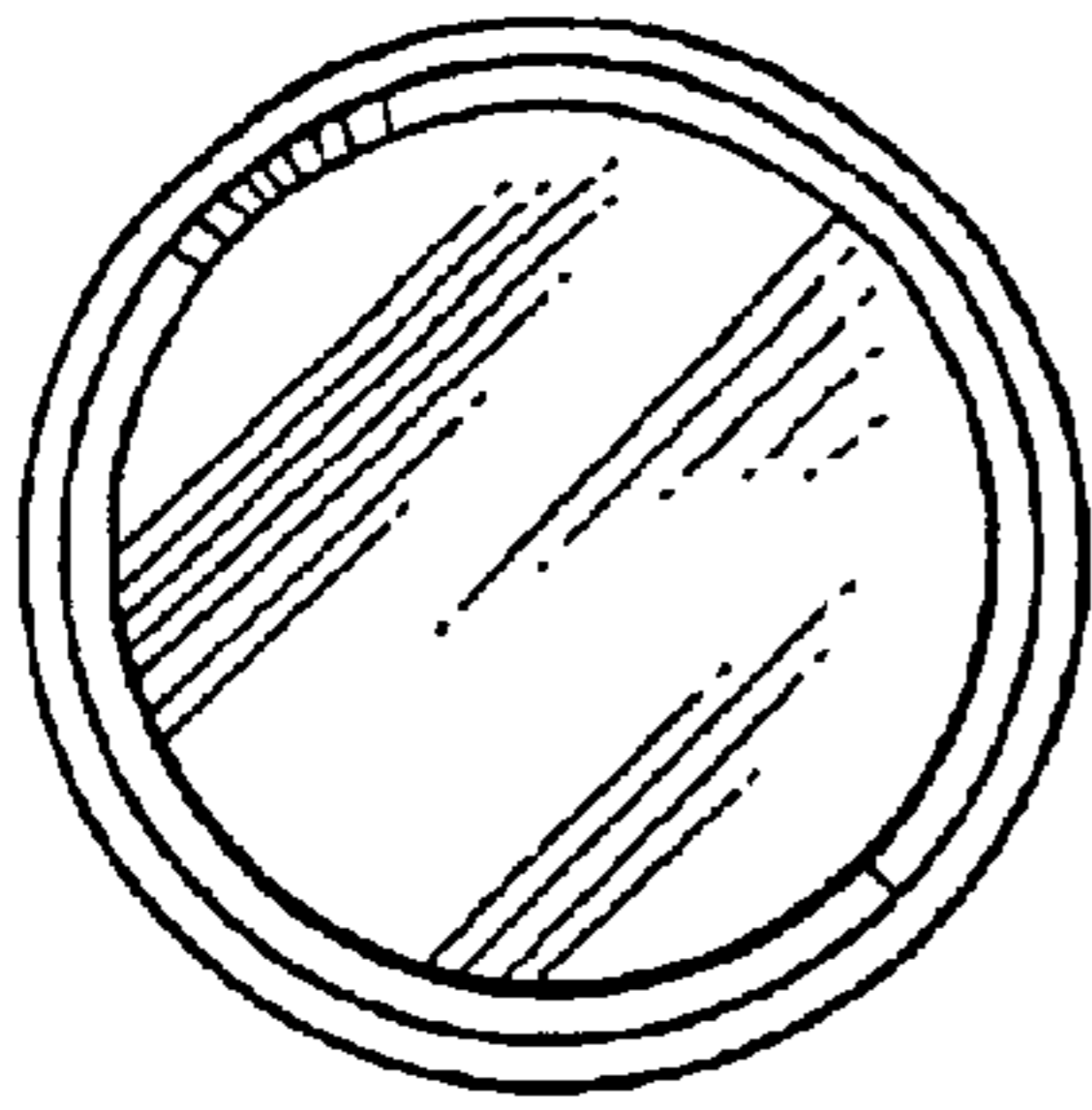

FIG. 16

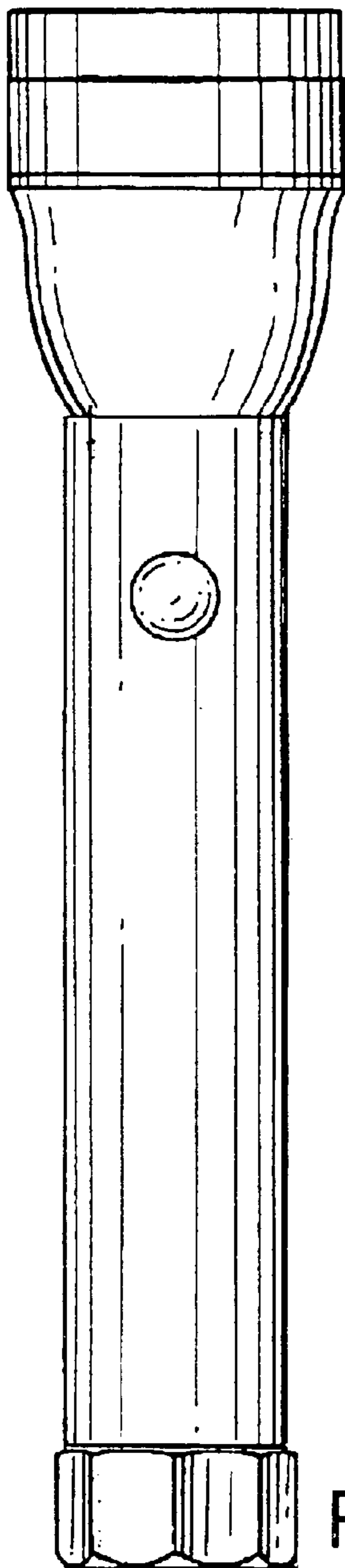

FIG. 17

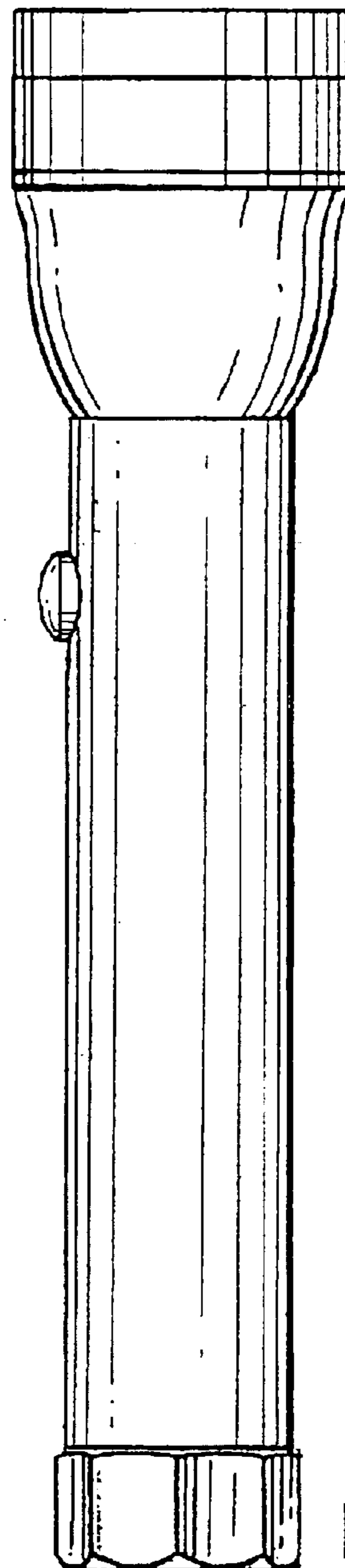

FIG. 18

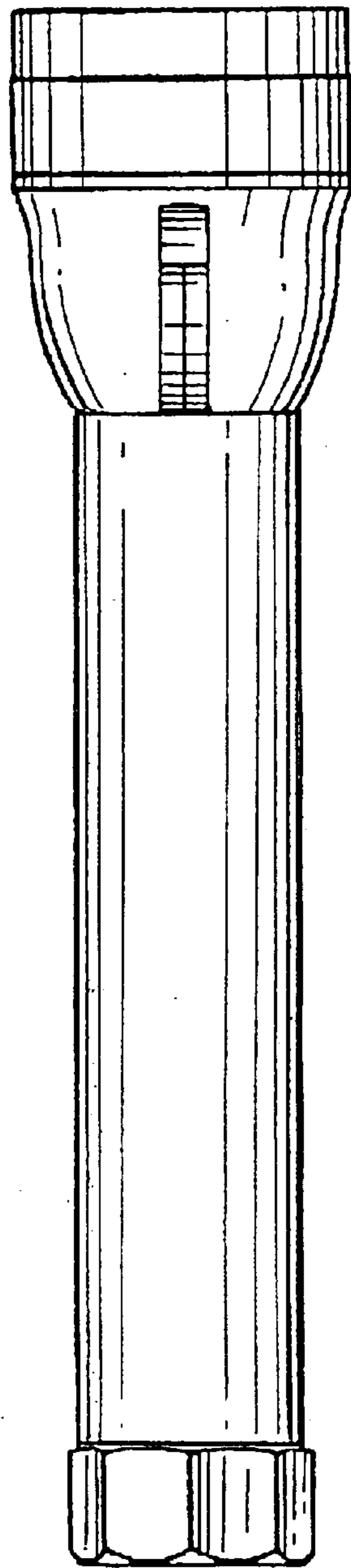

FIG. 19

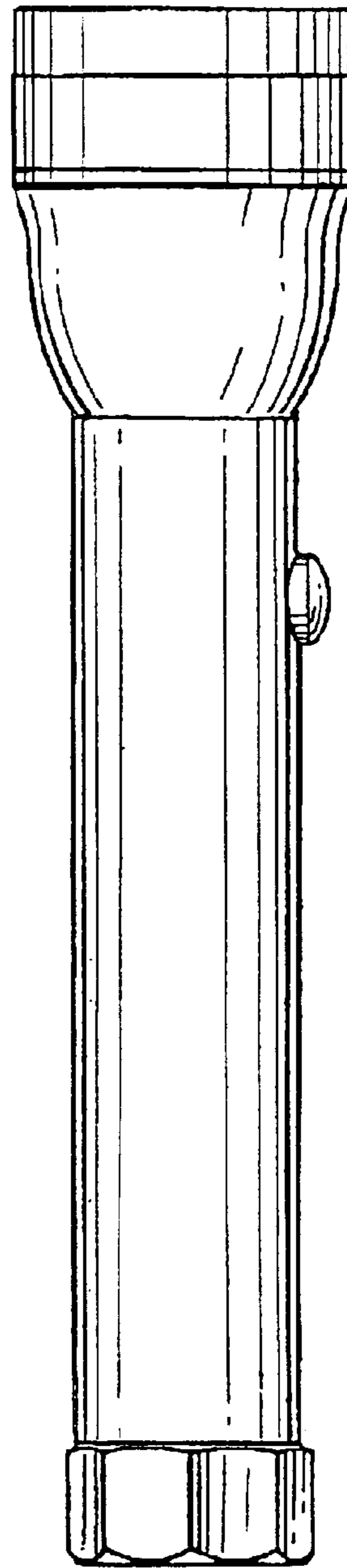

FIG. 20

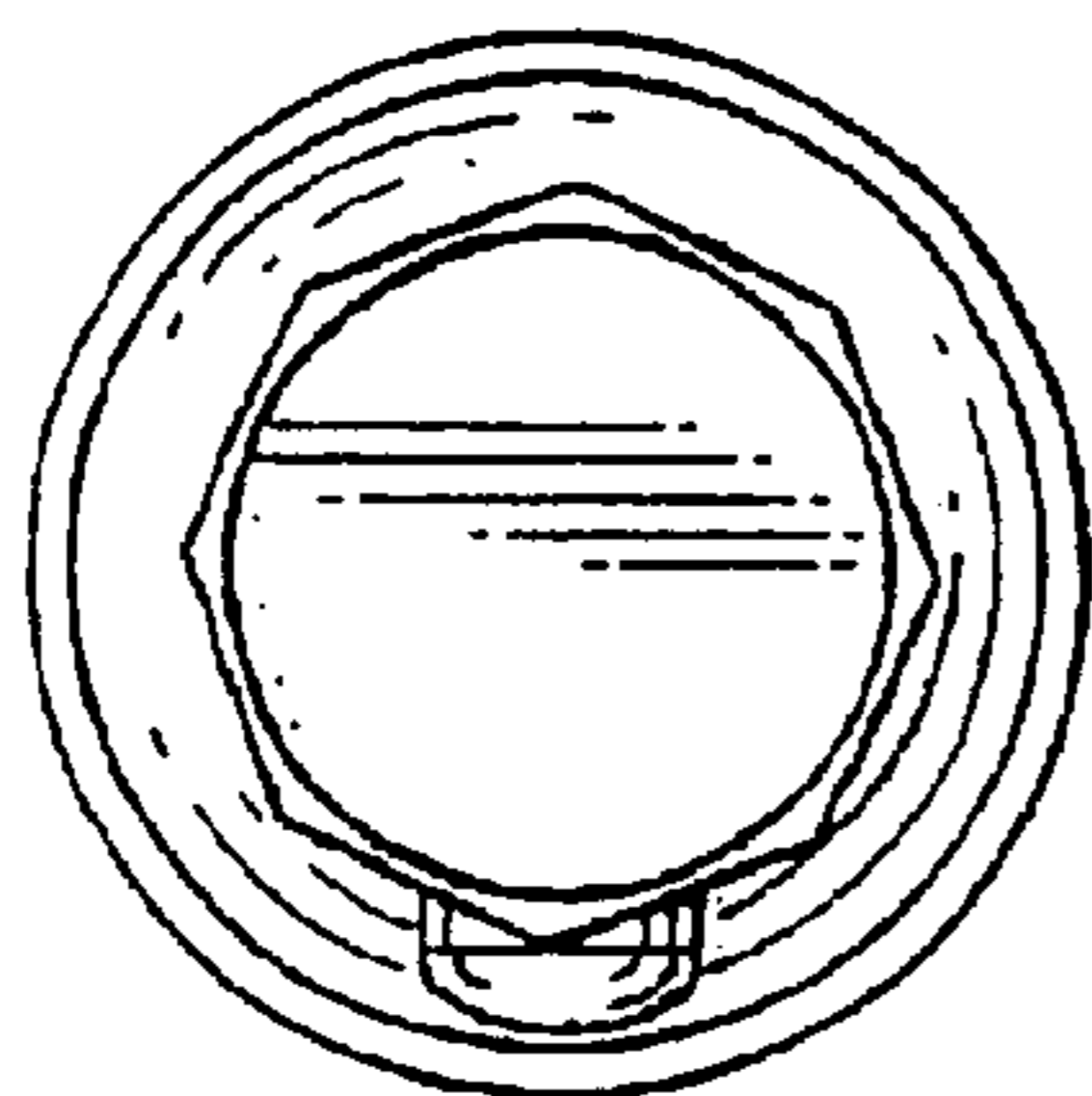

FIG. 21

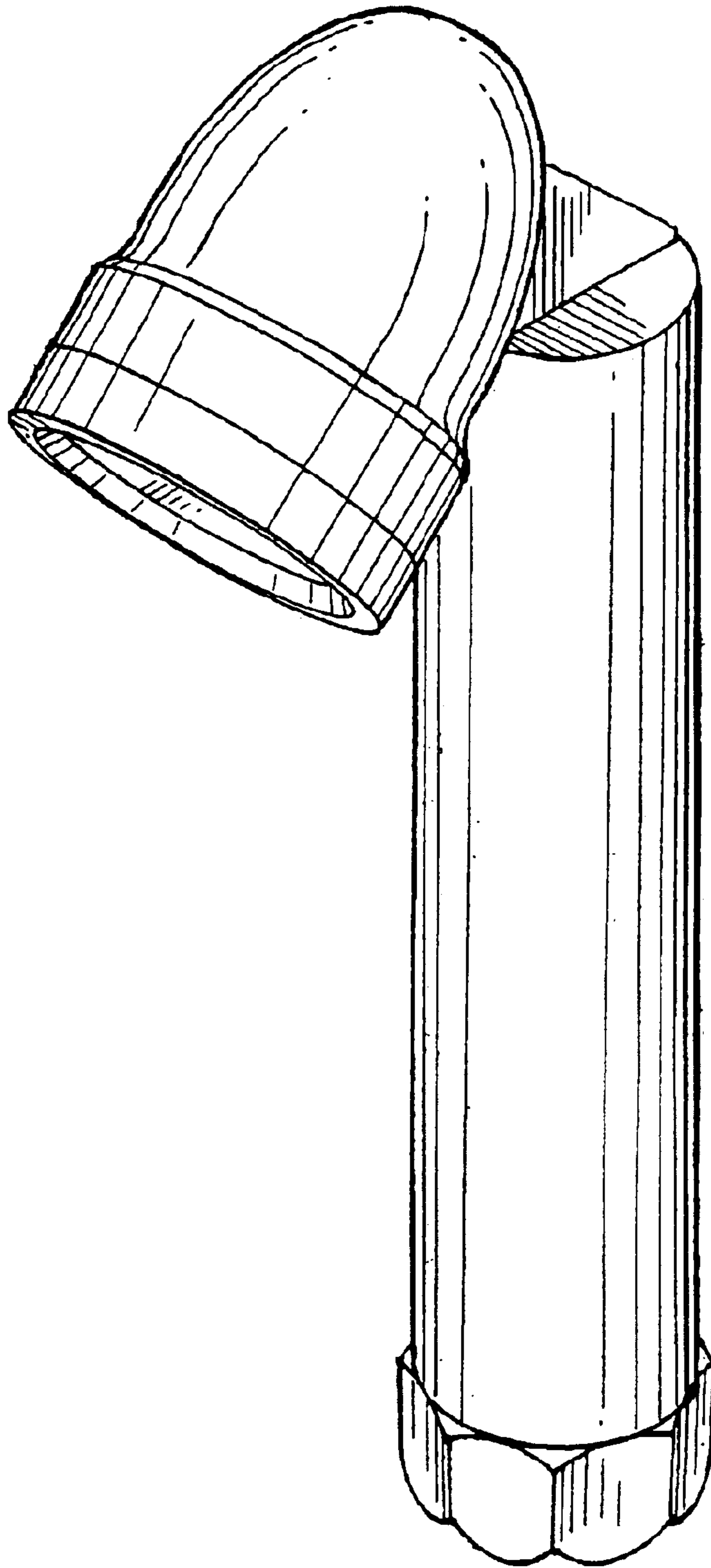

FIG.22

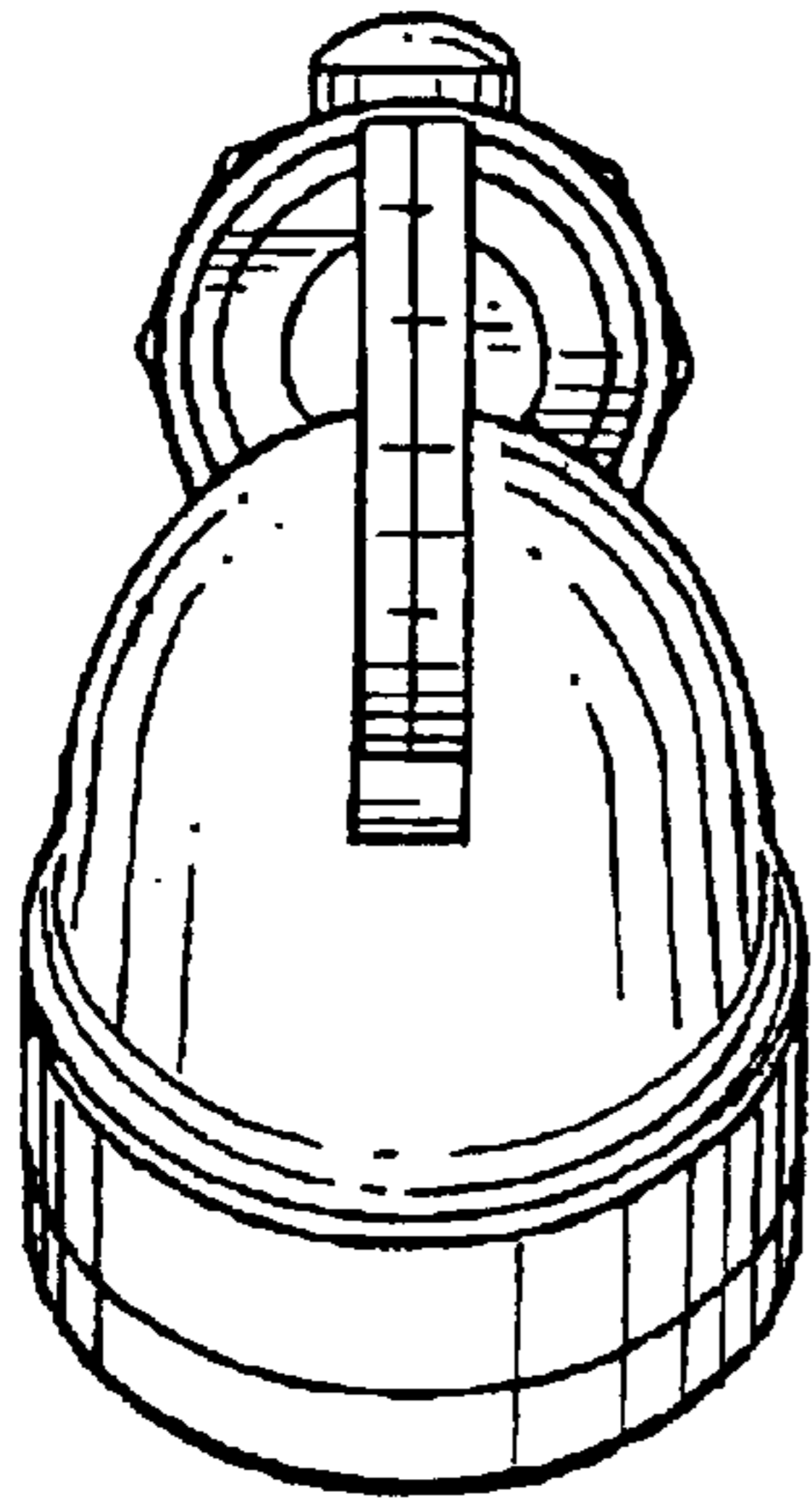

FIG. 23

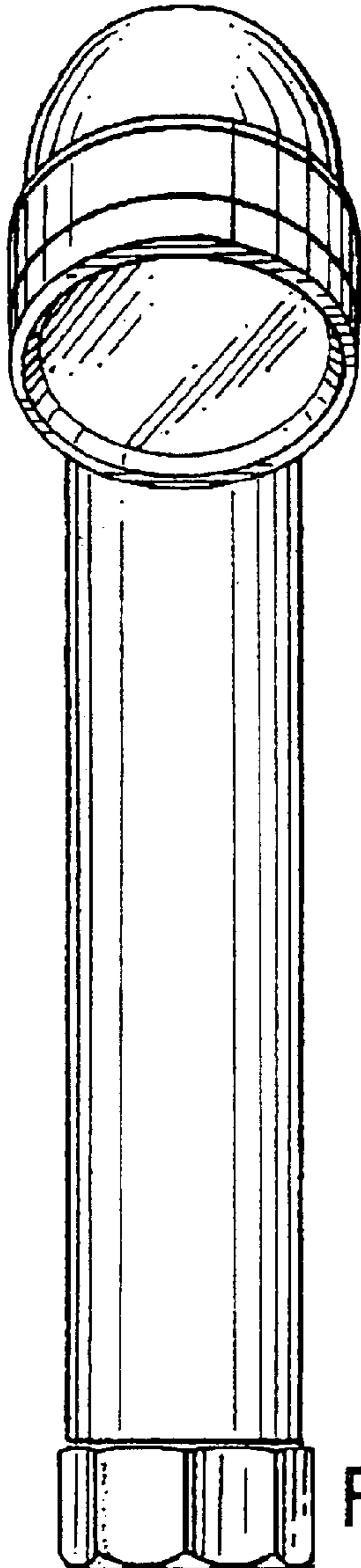

FIG. 24

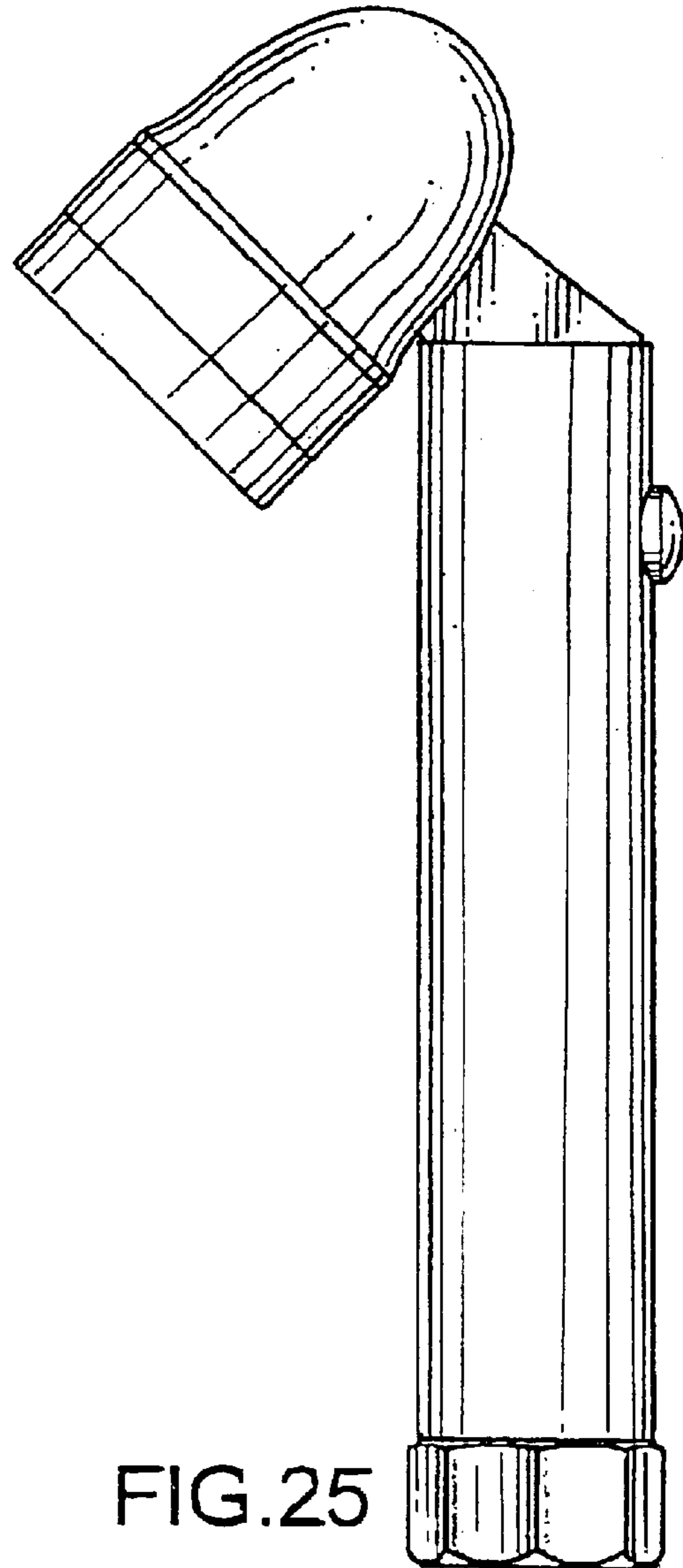

FIG. 25

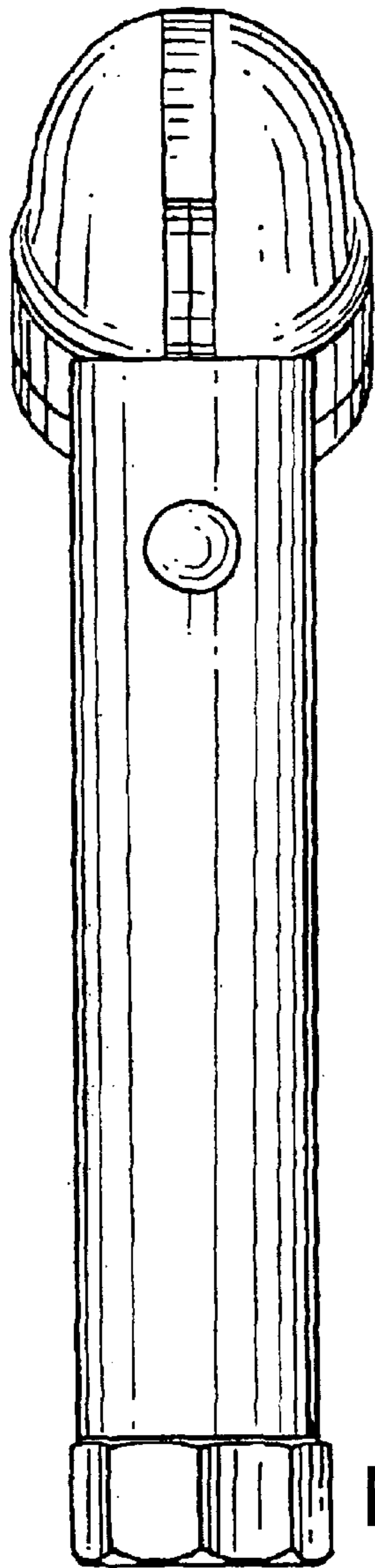

FIG. 26

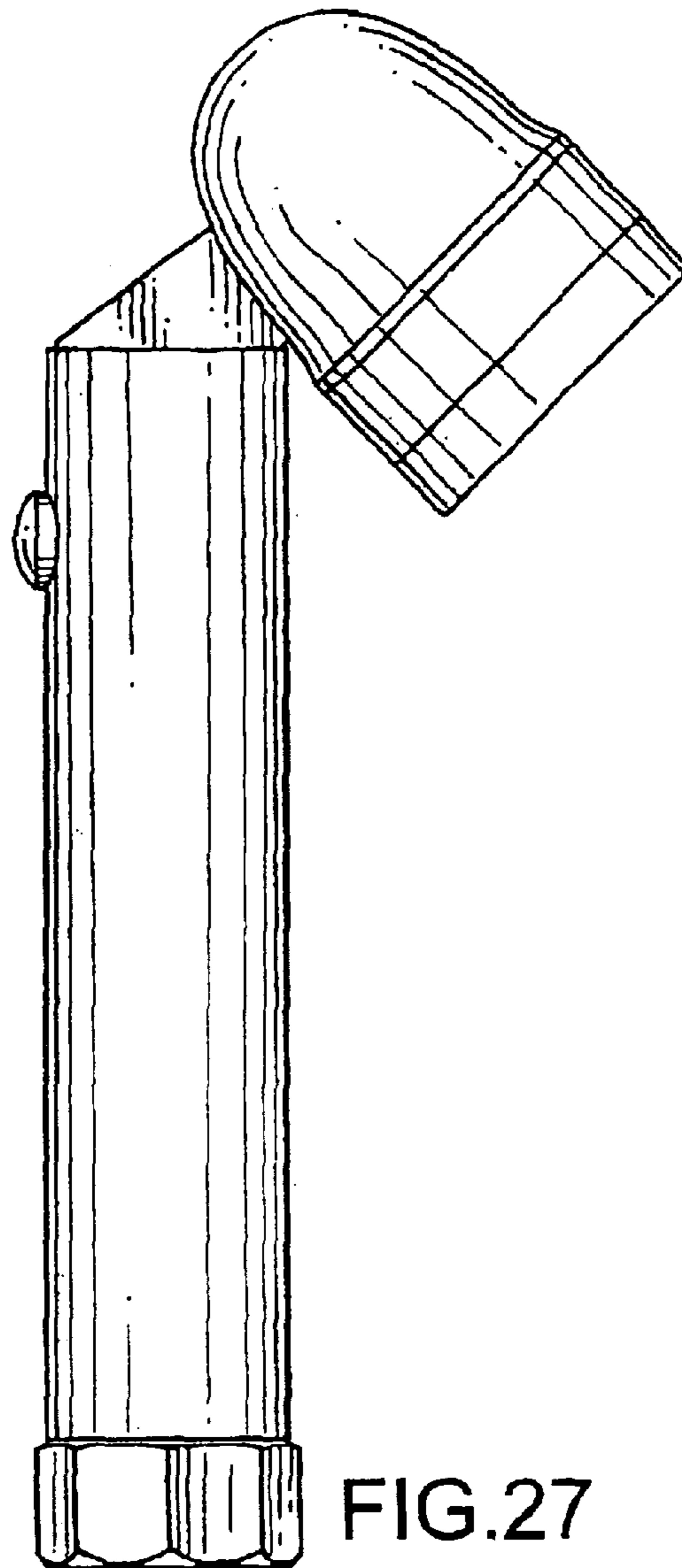

FIG. 27

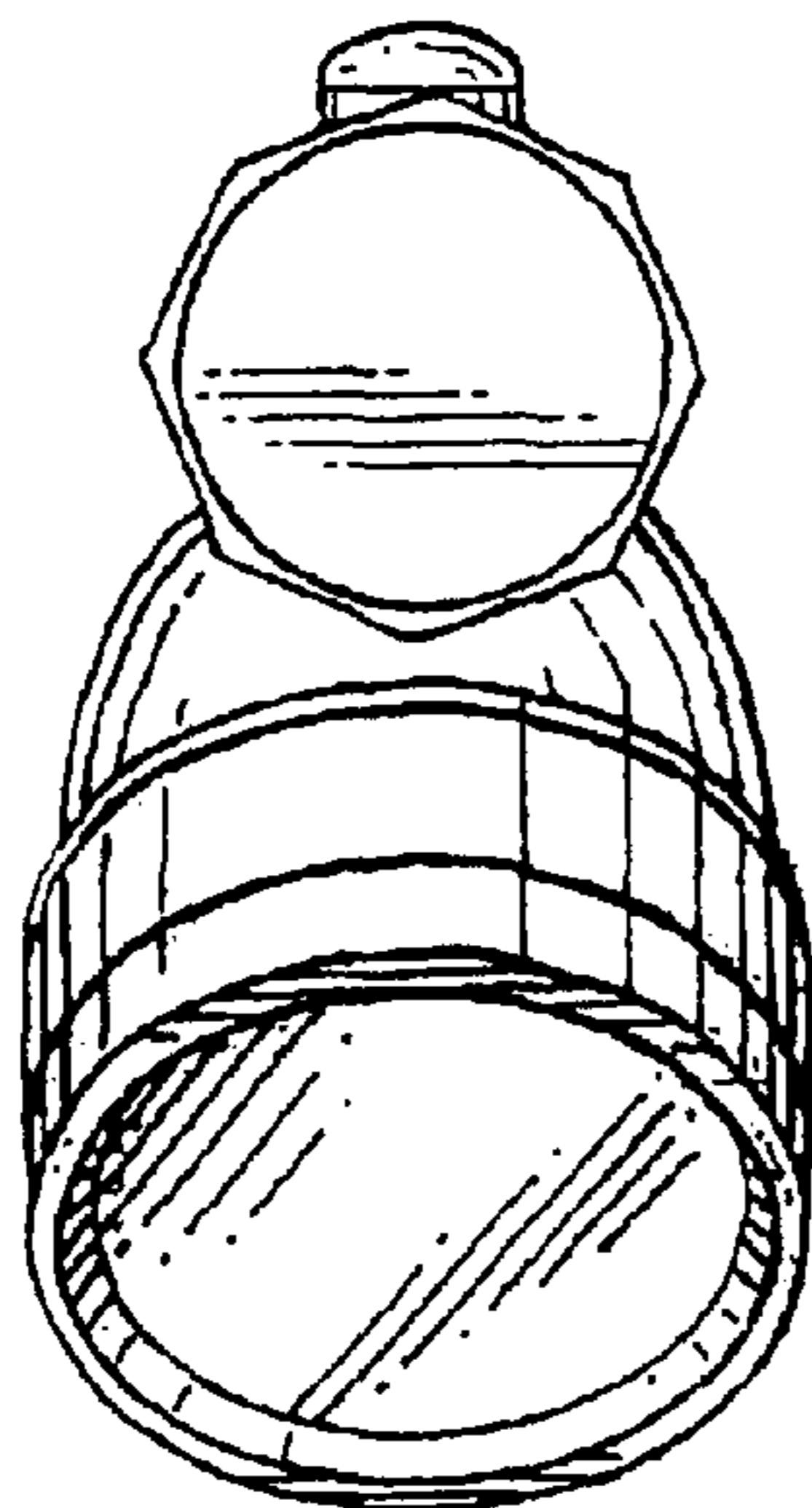

FIG. 28