



US00D518127S

(12) **United States Design Patent**
Tang et al.

(10) **Patent No.:** **US D518,127 S**
(45) **Date of Patent:** **** Mar. 28, 2006**

(54) **PUTTER HEAD**
(75) Inventors: **Larry G. Tang**, Carlsbad, CA (US);
Augustin W. Rollinson, San Diego, CA
(US); **Roger Cleveland**, Los Angeles,
CA (US)
(73) Assignee: **Callaway Golf Company**, Carlsbad,
CA (US)
(**) Term: **14 Years**
(21) Appl. No.: **29/216,038**
(22) Filed: **Oct. 27, 2004**
(51) **LOC (8) Cl.** **21-02**
(52) **U.S. Cl.** **D21/742**
(58) **Field of Classification Search** D21/736-746;
473/324-331, 340, 341, 251-256
See application file for complete search history.

2,781,197 A 2/1957 Wiley
2,838,312 A 6/1958 Drake
2,957,696 A 10/1960 Warpotas
3,021,141 A 7/1962 Polsky et al.
3,064,975 A 11/1962 Smith
D200,585 S 3/1965 Cefaly
3,194,564 A 7/1965 Swan
3,220,733 A 11/1965 Saleeby
3,300,241 A 1/1967 Eberwein et al.
3,310,879 A 3/1967 Brzezinski et al.
3,328,032 A 6/1967 Griswold
3,333,854 A 8/1967 White
3,343,839 A 9/1967 Borah
D209,294 S 11/1967 Hitt
3,357,705 A 12/1967 Blanchard
3,408,074 A 10/1968 Antonious
3,411,789 A 11/1968 Wariner
D217,487 S 5/1970 Blake
3,512,262 A 5/1970 Smyk et al.
3,578,332 A 5/1971 Caldwell
3,632,112 A 1/1972 Jacobs
3,708,182 A 1/1973 Rango
3,779,398 A 12/1973 Hunter
D230,293 S 2/1974 Gall
D230,294 S 2/1974 Gall
D230,615 S 3/1974 Delgadillo
3,806,129 A 4/1974 Burrows

(56) **References Cited**
U.S. PATENT DOCUMENTS

1,485,272 A 2/1924 Kinsman
1,526,951 A 2/1925 Beaumont
1,546,612 A 7/1925 Barnes
1,652,404 A 12/1927 Munson
1,654,916 A 1/1928 Graveure
1,666,174 A 4/1928 Holland
1,703,199 A 2/1929 McClure
D85,510 S 11/1931 Beach
D90,924 S 10/1933 Replogle
1,960,110 A 1/1934 Iles
2,002,335 A 5/1935 Fiondella
D95,819 S 6/1935 Gourlay
2,056,335 A 10/1936 Wettlaufer
2,057,821 A 10/1936 Costello
D104,495 S 5/1937 Gallagher
2,156,025 A 4/1939 Paul
D146,431 S 3/1947 Liolich
2,447,967 A 8/1948 Stone
2,478,468 A 8/1949 Drake
2,708,579 A 5/1955 Hugman
D179,002 S 10/1956 Hoffmeister
D179,246 S 11/1956 Gillon

(Continued)

Primary Examiner—Mitchell Siegel
(74) *Attorney, Agent, or Firm*—Michael A. Catania; Elaine
H. Lo

(57) **CLAIM**

The ornamental design for a putter head, as shown and
described.

DESCRIPTION

FIG. 1 is a top perspective view thereof;
FIG. 2 is a top plan view thereof;
FIG. 3 is a front plan view thereof;
FIG. 4 is a toe view thereof;
FIG. 5 is a rear view thereof; and,
FIG. 6 is a bottom plan view thereof.

1 Claim, 2 Drawing Sheets

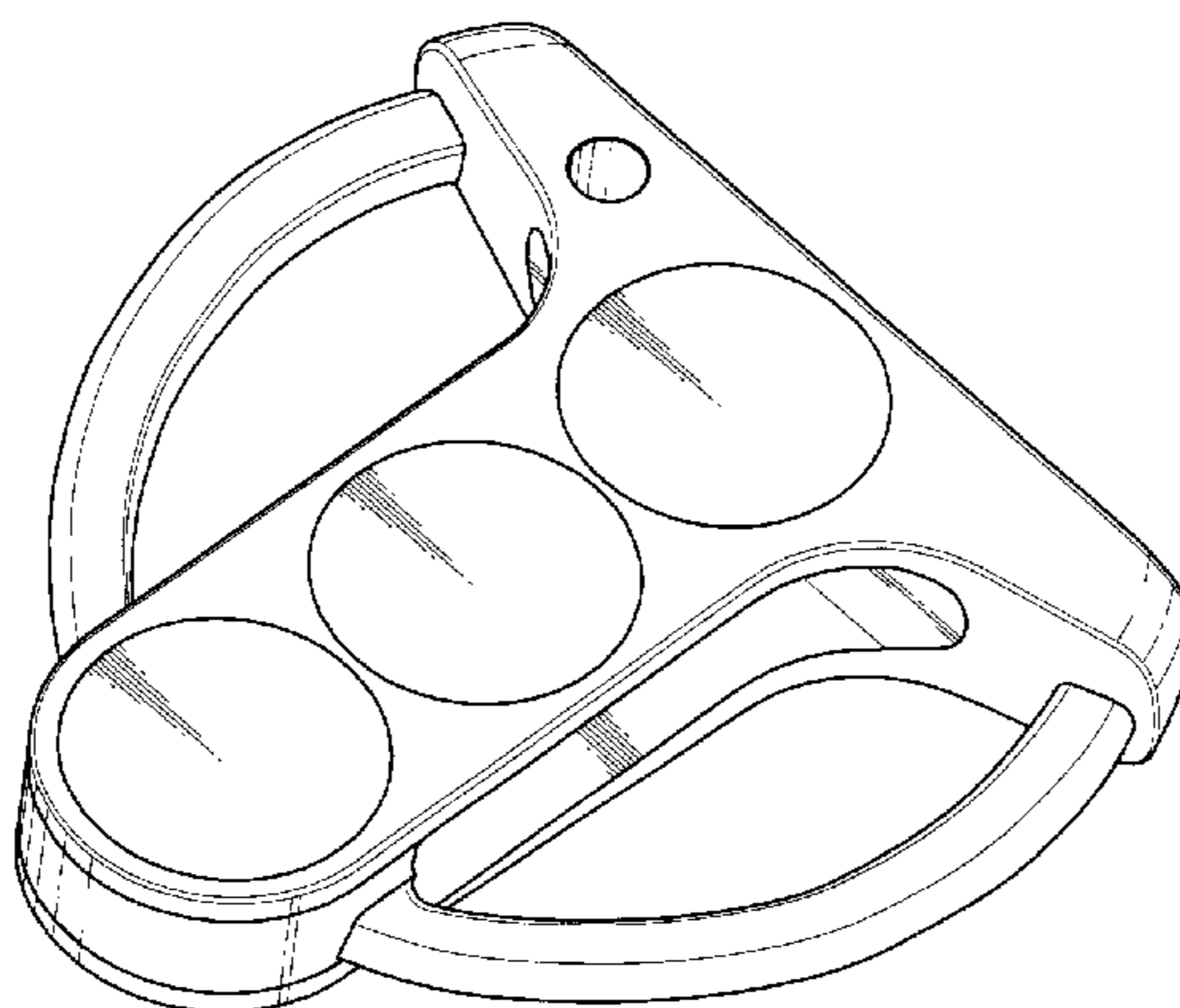

US D518,127 S

Page 2

U.S. PATENT DOCUMENTS

3,841,640 A	10/1974	Gaulocher	D337,803 S	7/1993	Sillers	
3,841,641 A	10/1974	Bennett	D374,470 S	10/1996	Steele	
D233,616 S	11/1974	Verzillo	D377,675 S	1/1997	Abel	
3,884,477 A	5/1975	Blanco	D380,801 S	7/1997	Steele	
3,918,720 A	11/1975	Gordos	5,685,784 A	11/1997	Butler	
D241,563 S	9/1976	McCord	D395,692 S	6/1998	Butler	
D245,437 S	8/1977	Thiel	D422,328 S	4/2000	Lannoch	
D248,050 S	5/1978	Muehl	D448,437 S	9/2001	Colucci	
D252,221 S	6/1979	Mariani	D461,860 S	8/2002	Tang	
4,278,254 A	7/1981	Simjian	D477,041 S	* 7/2003	Cameron	D21/742
4,314,701 A	2/1982	Swanson	D484,935 S	1/2004	Tang	
4,411,431 A	10/1983	Judice	D485,323 S	1/2004	Wagner et al.	
4,444,395 A	4/1984	Reiss	D486,194 S	2/2004	Helmstetter et al.	
4,519,612 A	5/1985	Tsao	D493,857 S	* 8/2004	Cameron	D21/738
4,688,798 A	8/1987	Pelz	D494,237 S	* 8/2004	Ware	D21/736
D309,765 S	8/1990	Pelz	D496,417 S	9/2004	Tang	
D309,766 S	8/1990	Pelz	D496,418 S	* 9/2004	Tang et al.	D21/738
D317,034 S	5/1991	Pelz	D506,796 S	* 6/2005	Li	D21/742
D317,962 S	7/1991	Pelz	D507,316 S	* 7/2005	Li	D21/742

* cited by examiner

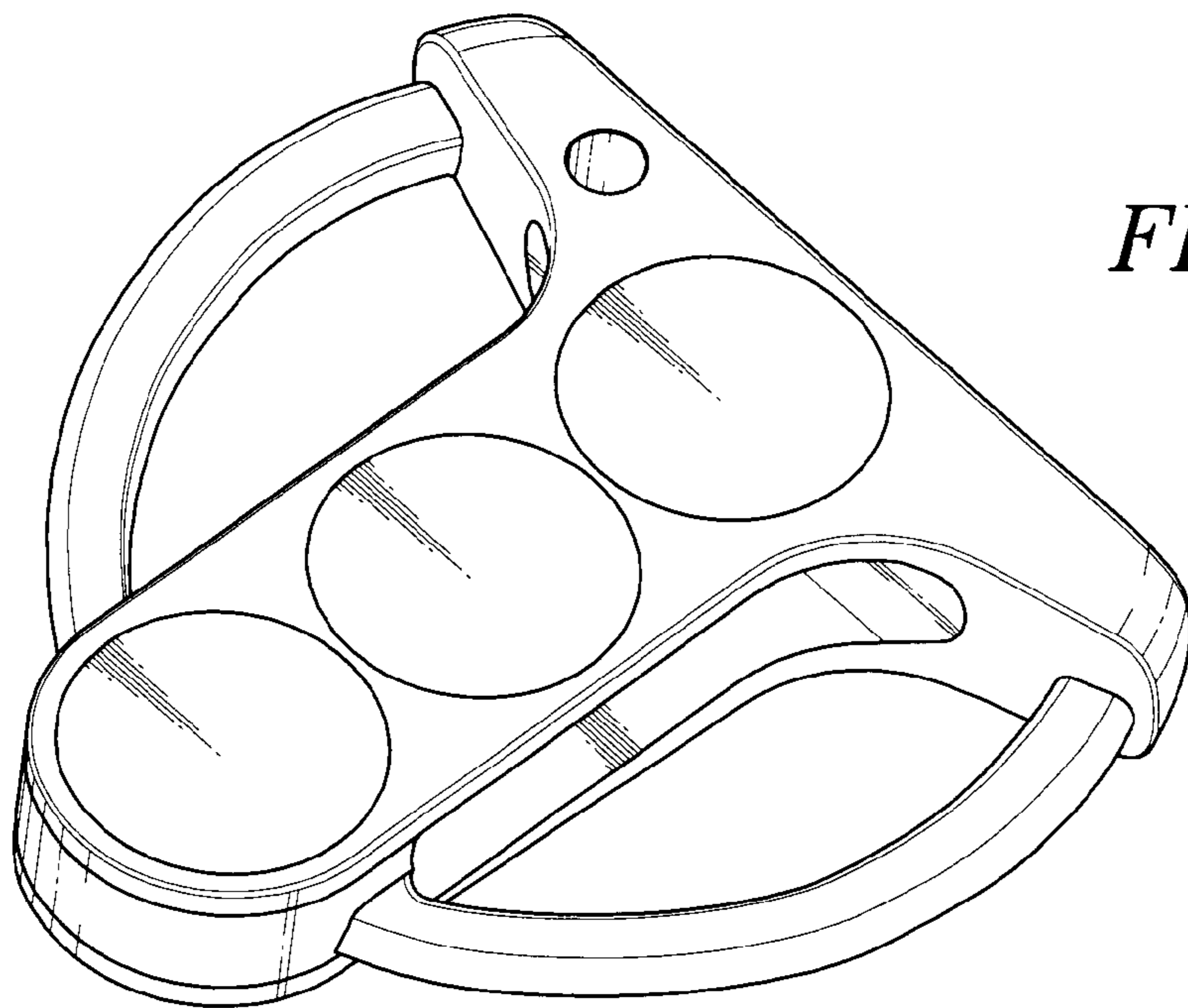

FIG. 1

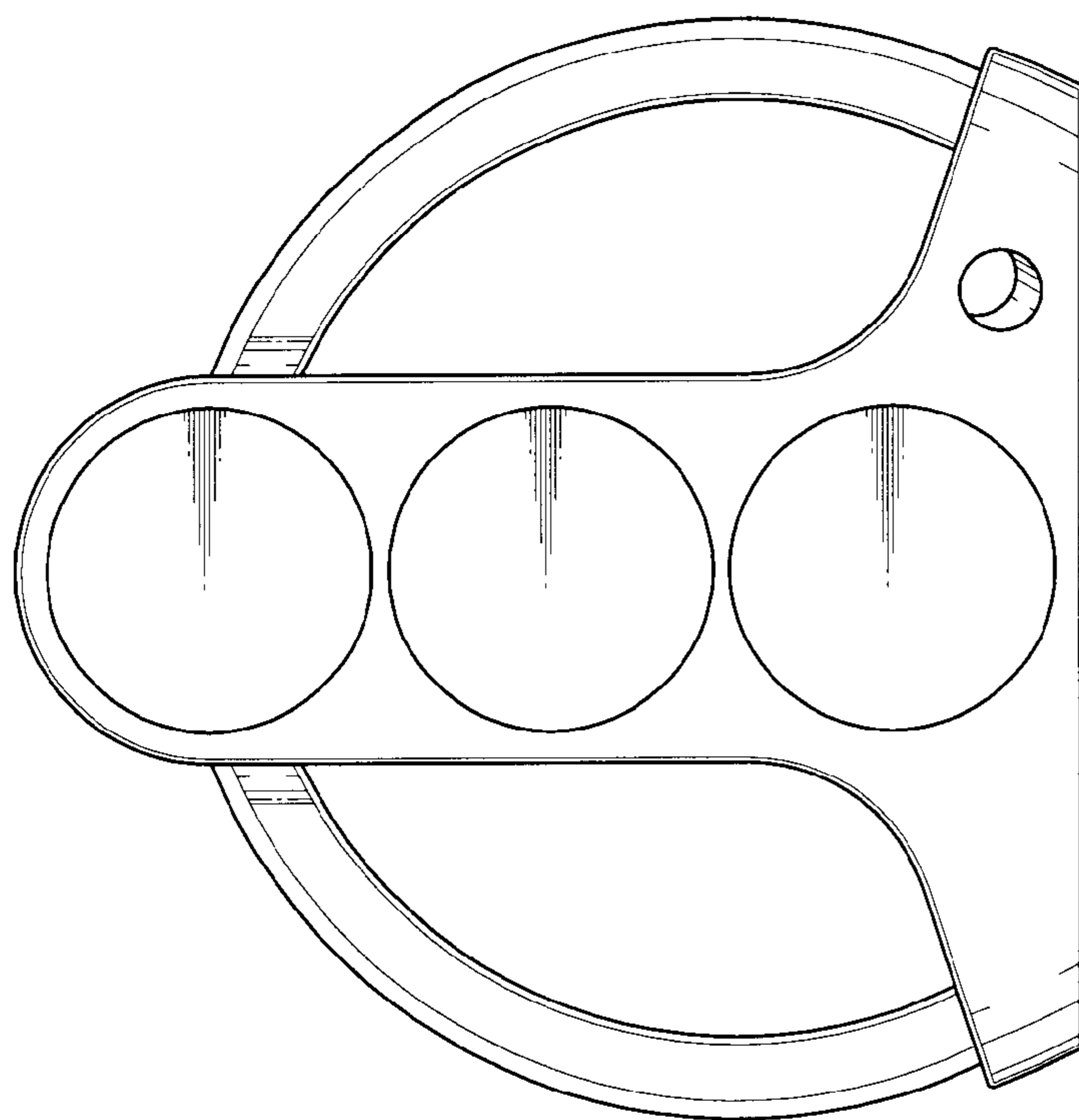

FIG. 2

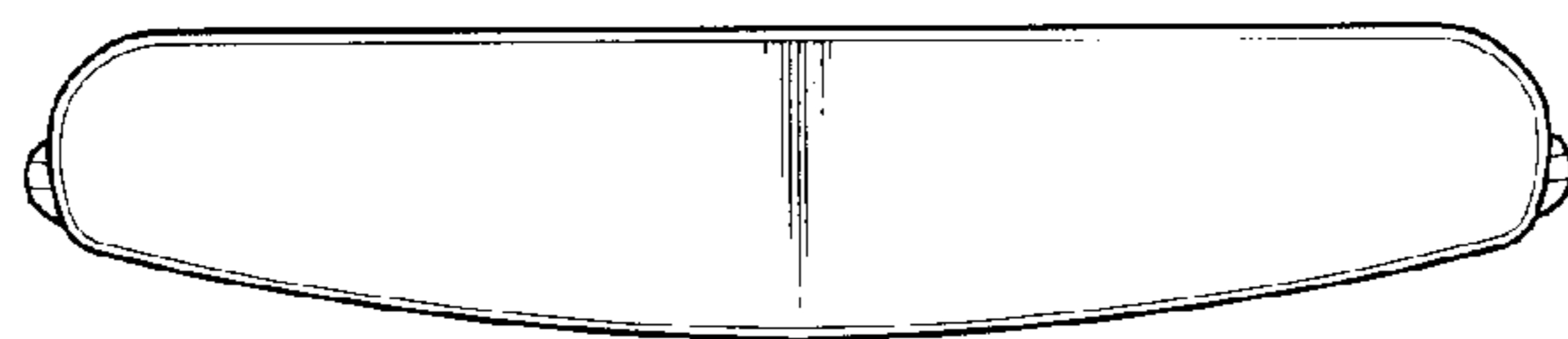

FIG. 3



FIG. 4



FIG. 5

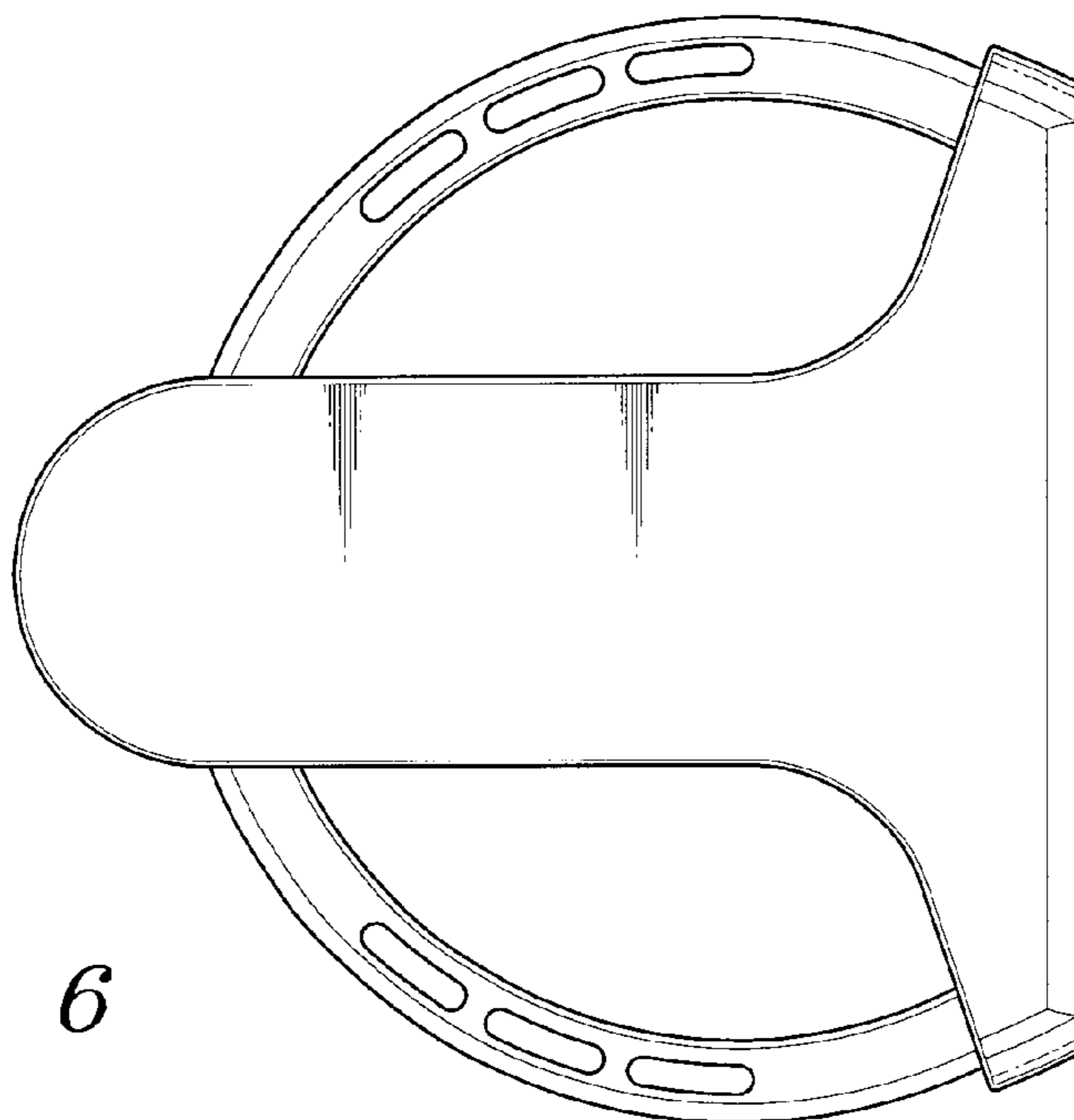

FIG. 6