



US00D518032S

(12) **United States Design Patent**
Sone

(10) **Patent No.:** **US D518,032 S**

(45) **Date of Patent:** **** Mar. 28, 2006**

(54) **SPEAKER**

D419,561 S * 1/2000 Haase et al. D14/216
D466,888 S * 12/2002 Sugiyama et al. D14/221

(75) Inventor: **Takahiro Sone**, Shizuoka (JP)

* cited by examiner

(73) Assignee: **Star Micronics Co., Ltd.**, Shizuoka (JP)

Primary Examiner—Nanda Bondade

(**) Term: **14 Years**

(74) *Attorney, Agent, or Firm*—Sughrue Mion, PLLC

(21) Appl. No.: **29/207,208**

(57) **CLAIM**

(22) Filed: **Jun. 10, 2004**

The ornamental design for a speaker, as shown and described.

(30) **Foreign Application Priority Data**

DESCRIPTION

Dec. 12, 2003 (JP) 2003-036805

FIG. 1 is a perspective view of the top and front of a speaker showing my new design;

(51) **LOC (8) Cl.** **14-01**

FIG. 2. is a front elevational view thereof;

(52) **U.S. Cl.** **D14/221**

FIG. 3 is a rear elevational view thereof;

(58) **Field of Classification Search** D14/204,
D14/207, 209–216, 356; D13/133, 184; 181/143–144,
181/147–148, 150, 157, 198–199, 151, 153;
381/300–302, 306, 333, 345, 361–364, 386–388,
381/332, 336

FIG. 4 is a right side elevational view thereof;

FIG. 5 is a left side elevational view thereof;

See application file for complete search history.

FIG. 6 is a top plan view thereof; and,

FIG. 7. is a bottom plan view thereof.

The broken line showing on the drawings is for illustrative purposes only and forms no part of the claimed design.

(56) **References Cited**

U.S. PATENT DOCUMENTS

5,133,428 A * 7/1992 Perrson 181/153

1 Claim, 4 Drawing Sheets

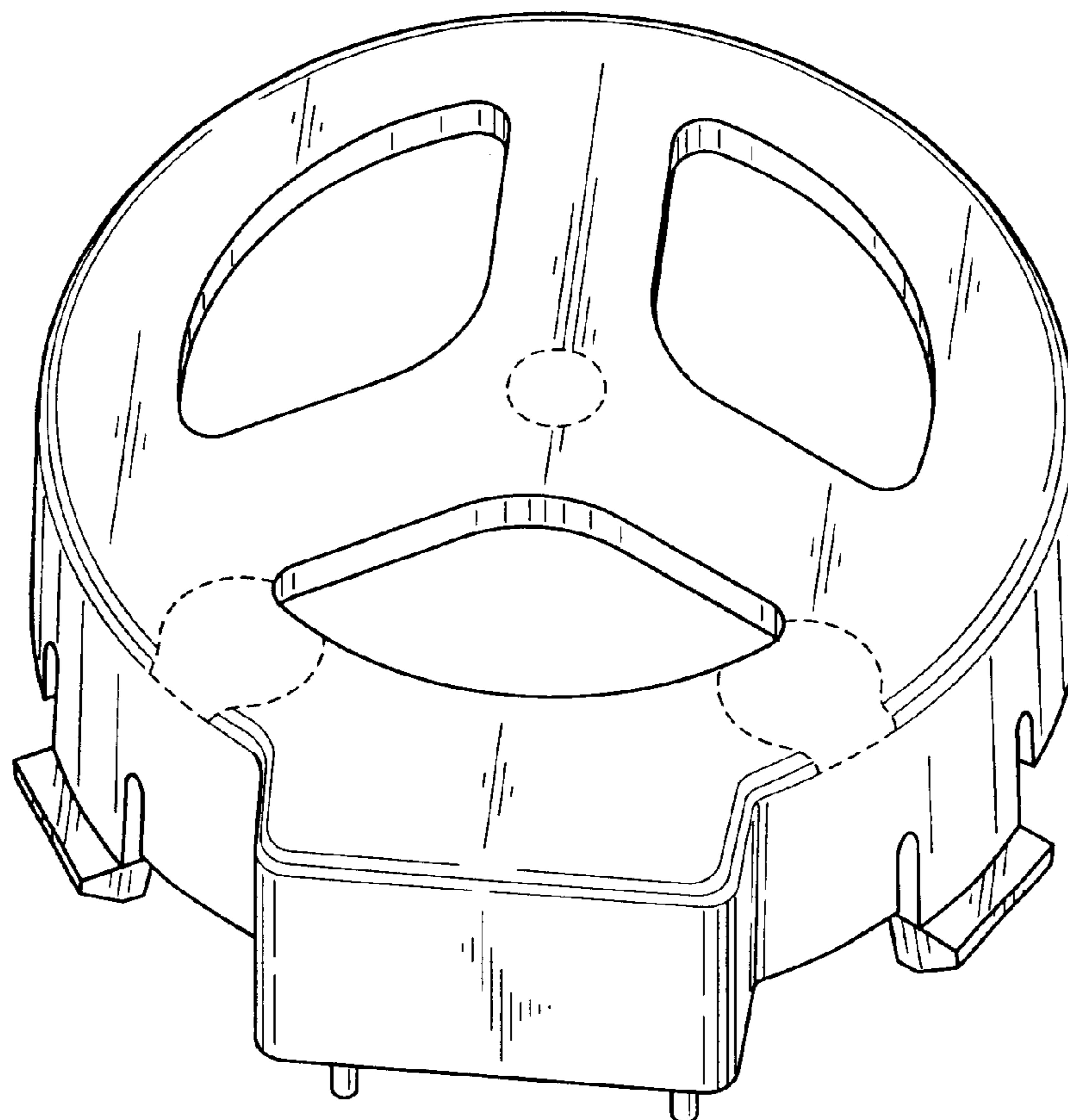

FIG. 1

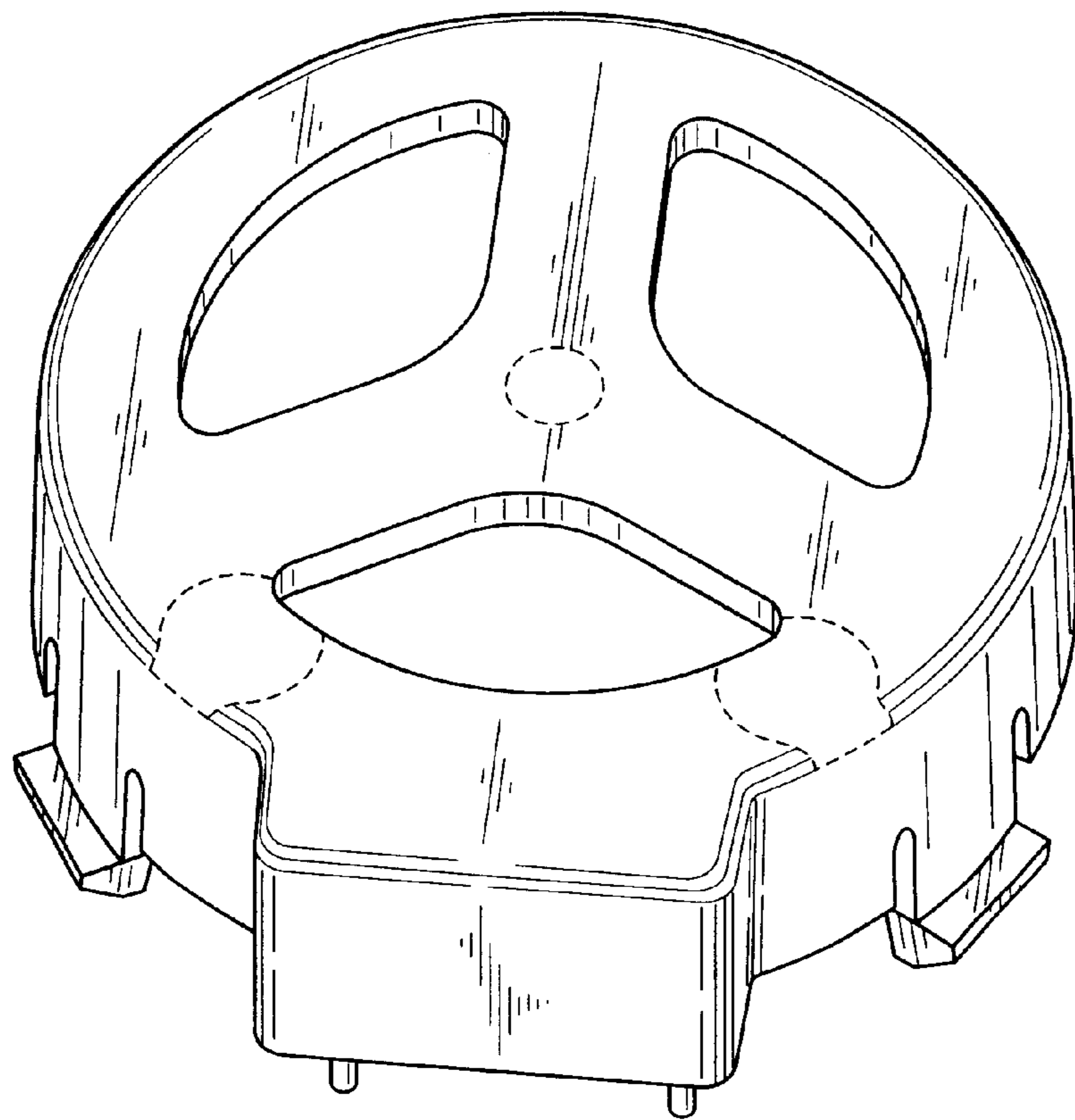

FIG. 2

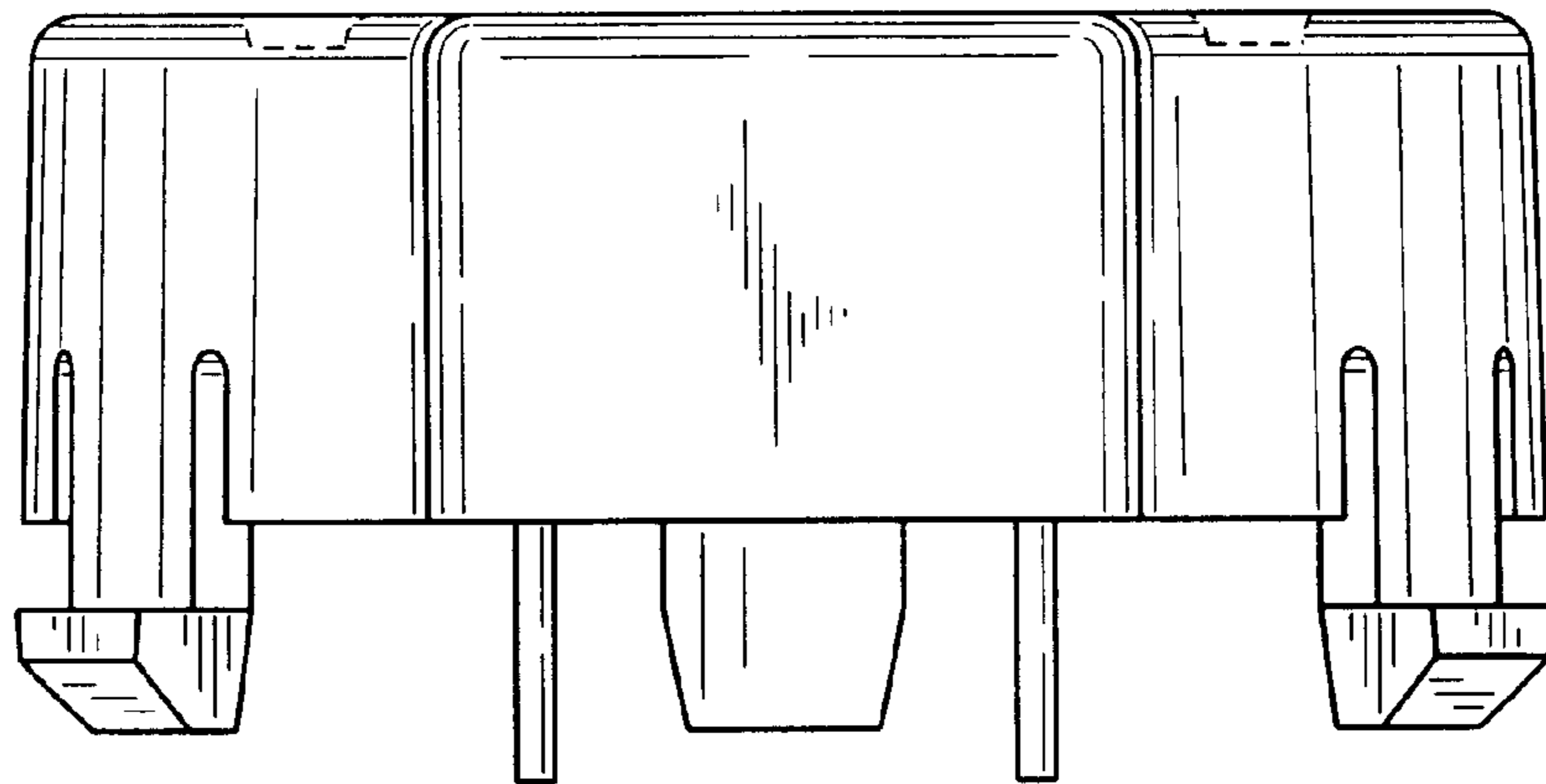

FIG. 3

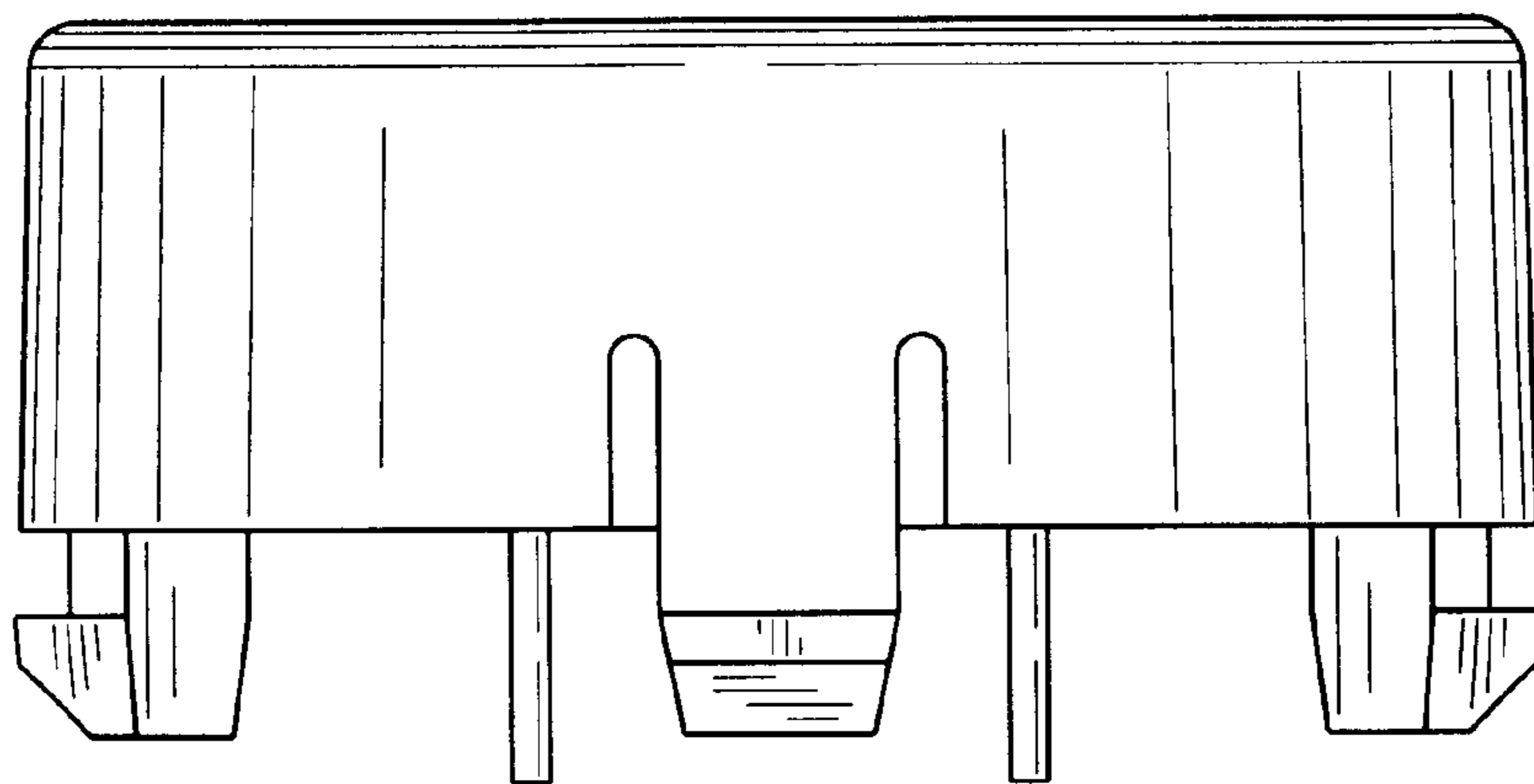

FIG. 4

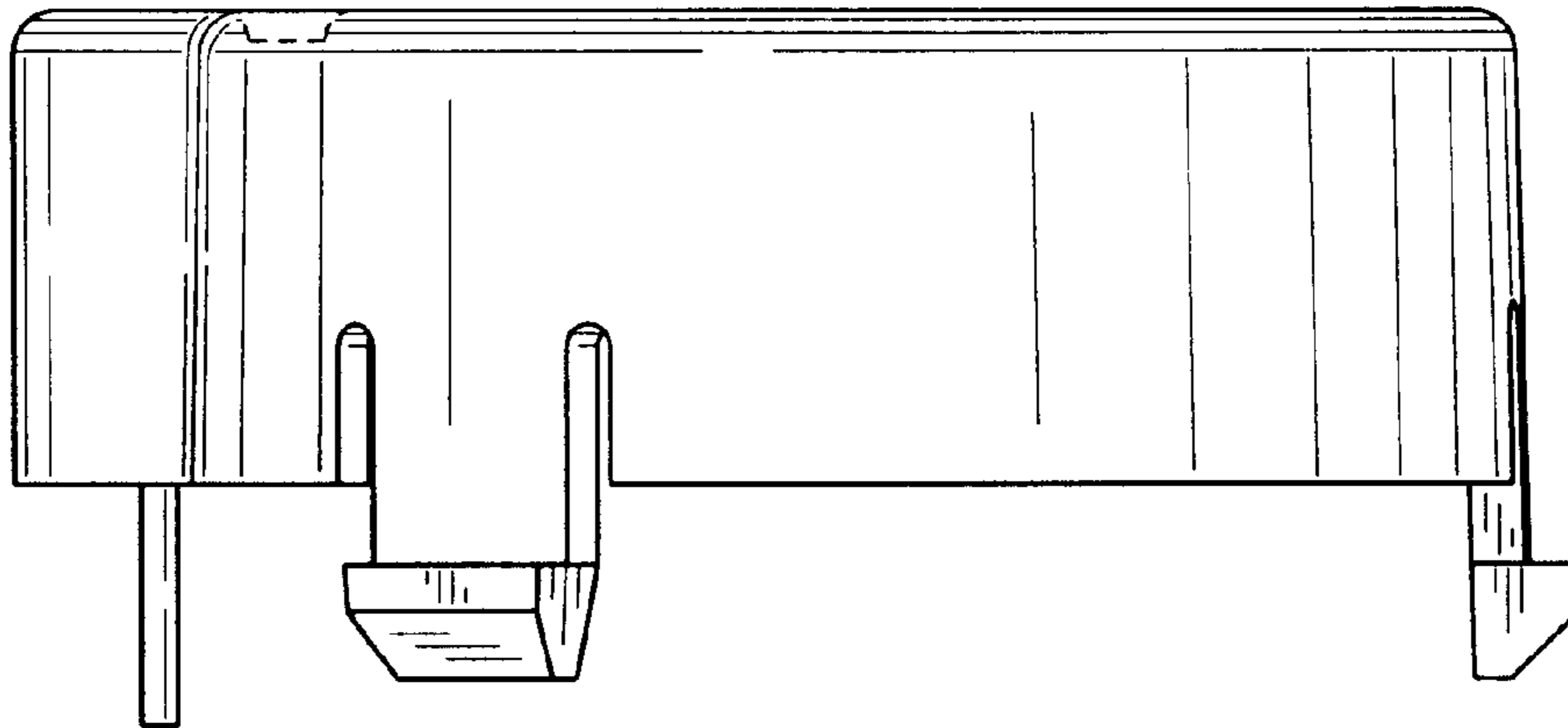

FIG. 5

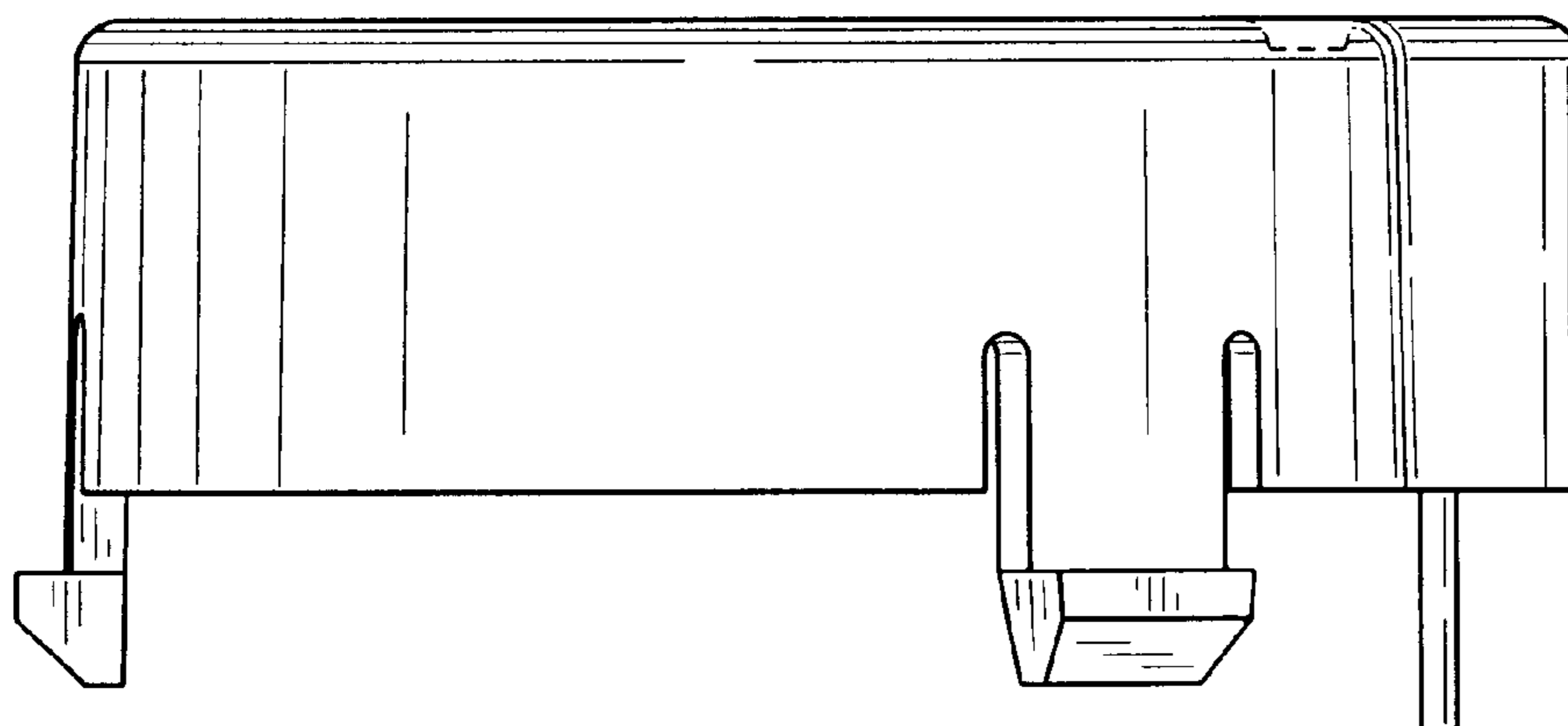

FIG. 6

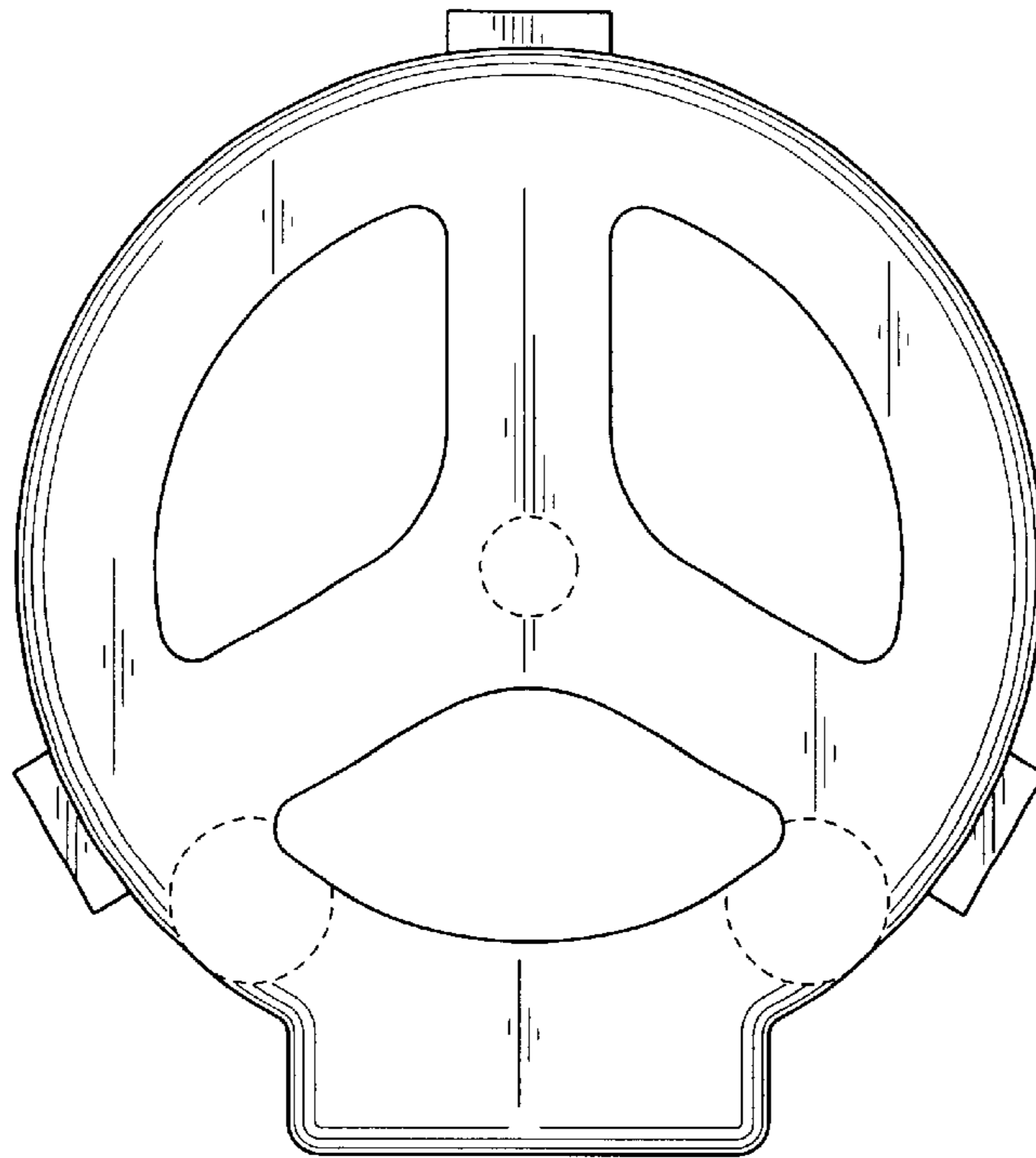

FIG. 7

