



US00D517991S

(12) **United States Design Patent**
Riku

(10) **Patent No.:** **US D517,991 S**

(45) **Date of Patent:** **** *Mar. 28, 2006**

(54) **ELECTRICAL CONNECTOR**

(75) Inventor: **Kazuya Riku**, Tokyo (JP)

(73) Assignee: **Tyco Electronics AMP K.K.**,
Kanagawa-ken (JP)

(*) Notice: This patent is subject to a terminal disclaimer.

(**) Term: **14 Years**

(21) Appl. No.: **29/219,179**

(22) Filed: **Dec. 13, 2004**

(30) **Foreign Application Priority Data**

Jun. 15, 2004 (JP) 2004-017864

(51) **LOC (8) Cl.** **13-03**

(52) **U.S. Cl.** **D13/147**

(58) **Field of Classification Search** D13/133,
D13/184, 154, 199, 146-147; 439/79, 101,
439/108, 344, 350, 352, 447, 557, 571, 573,
439/540.1, 541.5, 607-608, 825

See application file for complete search history.

(56) **References Cited**

U.S. PATENT DOCUMENTS

5,024,609 A * 6/1991 Piorunneck 439/637
5,630,720 A * 5/1997 Kocher 439/78
5,755,595 A * 5/1998 Davis et al. 439/607
D407,070 S * 3/1999 Chang D13/147

D418,480 S * 1/2000 Yeh D13/147
6,149,468 A * 11/2000 Meng 439/637
6,210,240 B1 * 4/2001 Comerci et al. 439/853
D446,774 S * 8/2001 Zhu et al. D13/147
6,319,075 B1 11/2001 Clark et al.
6,331,122 B1 * 12/2001 Wu 439/567
D453,735 S * 2/2002 Yoneyama et al. D13/147
D455,127 S * 4/2002 Wu D13/147

* cited by examiner

Primary Examiner—Stella Reid

Assistant Examiner—Daniel Bui

(74) *Attorney, Agent, or Firm*—Barley Snyder LLC

(57) **CLAIM**

The ornamental design for an electrical connector, as shown and described.

DESCRIPTION

FIG. 1 is a front elevation view of an electrical connector, showing my new design;

FIG. 2 is a top plan view thereof;

FIG. 3 is a bottom plan view thereof;

FIG. 4 is a right side elevation view thereof;

FIG. 5 is a left side elevation view thereof;

FIG. 6 is a rear elevation view thereof;

FIG. 7 is a cross sectional view thereof; taken along the line 7-7 in FIG. 1;

FIG. 8 is a cross sectional view thereof; taken along the line 8-8 in FIG. 1; and,

FIG. 9 is a top, front and right side perspective view thereof.

1 Claim, 9 Drawing Sheets

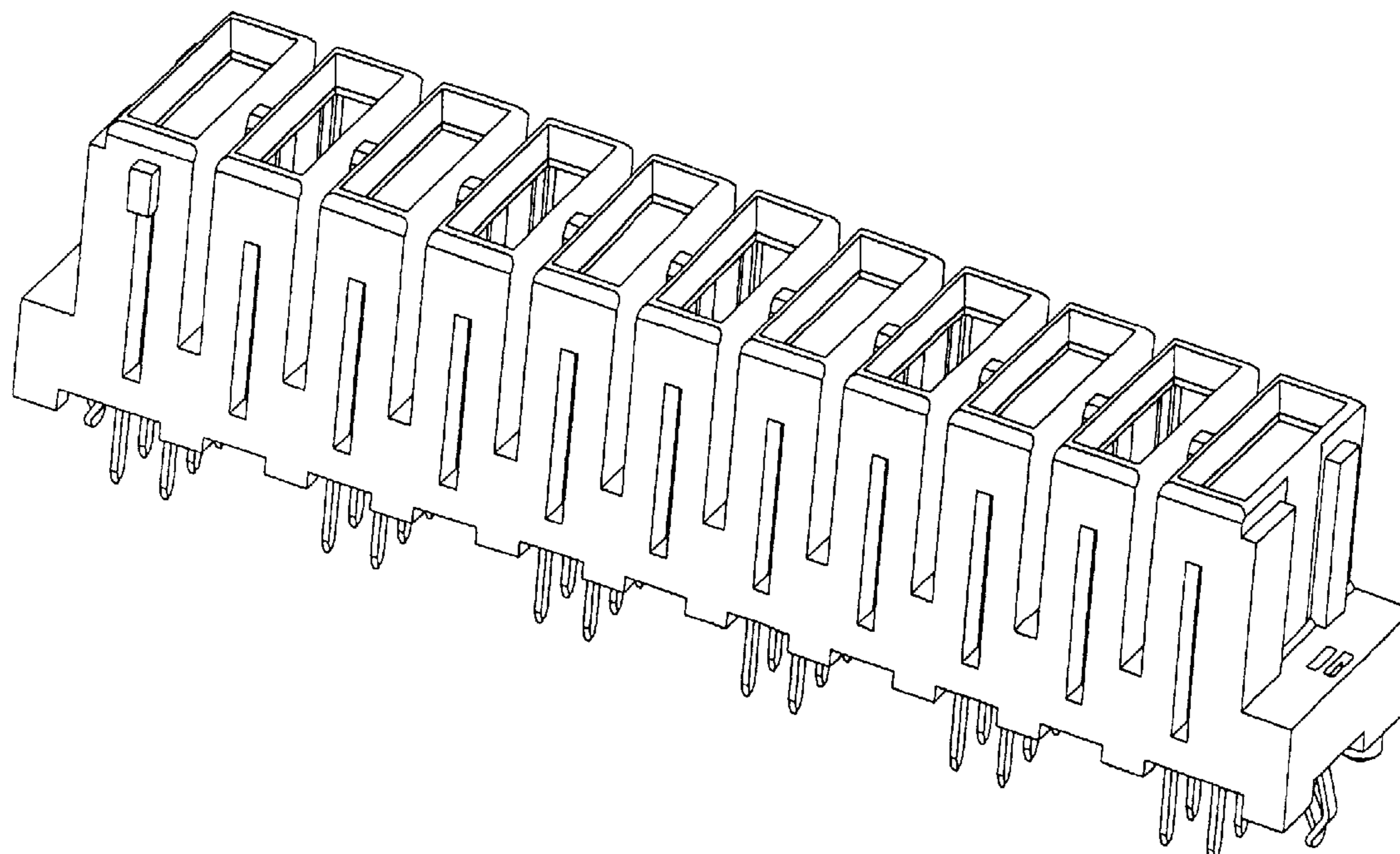

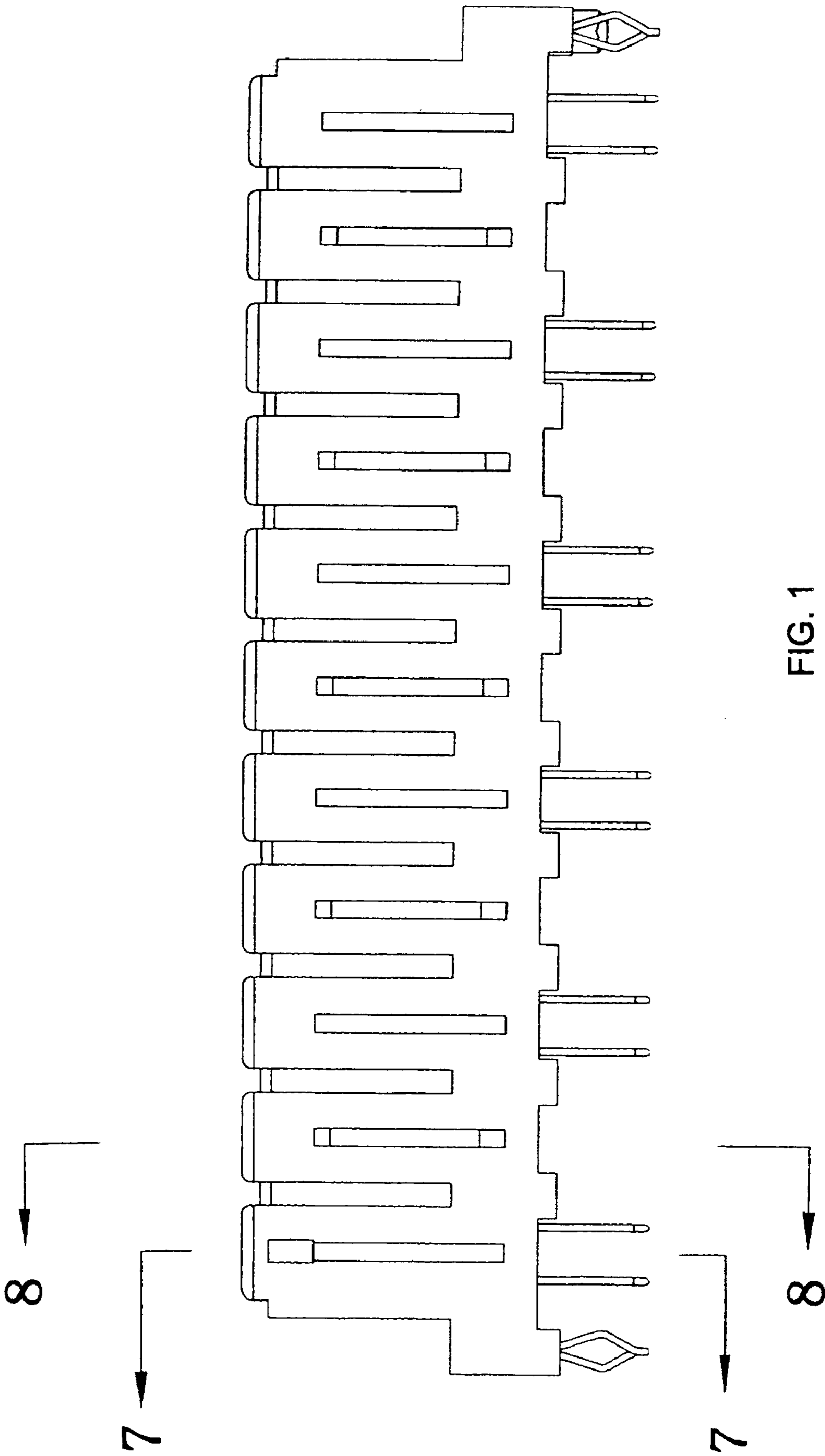

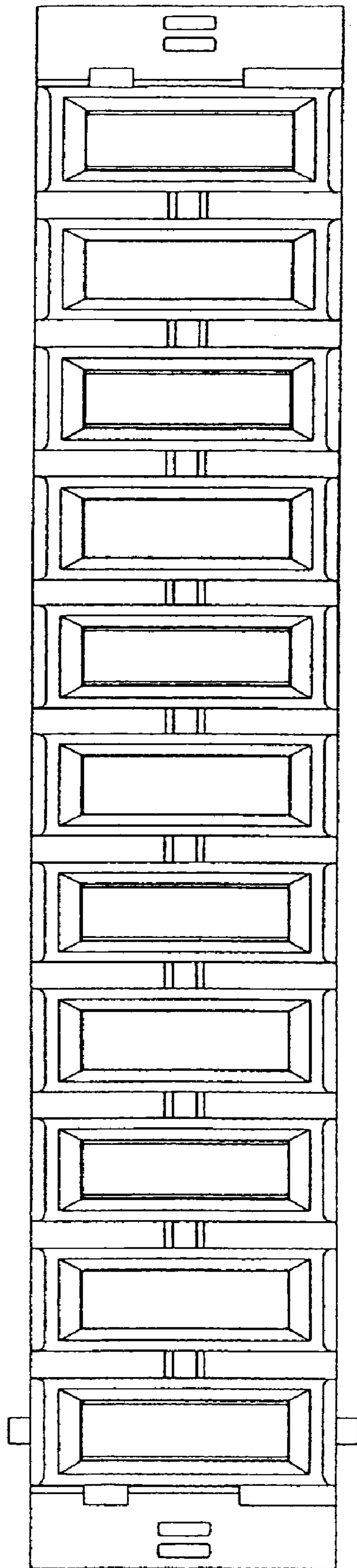

FIG. 2

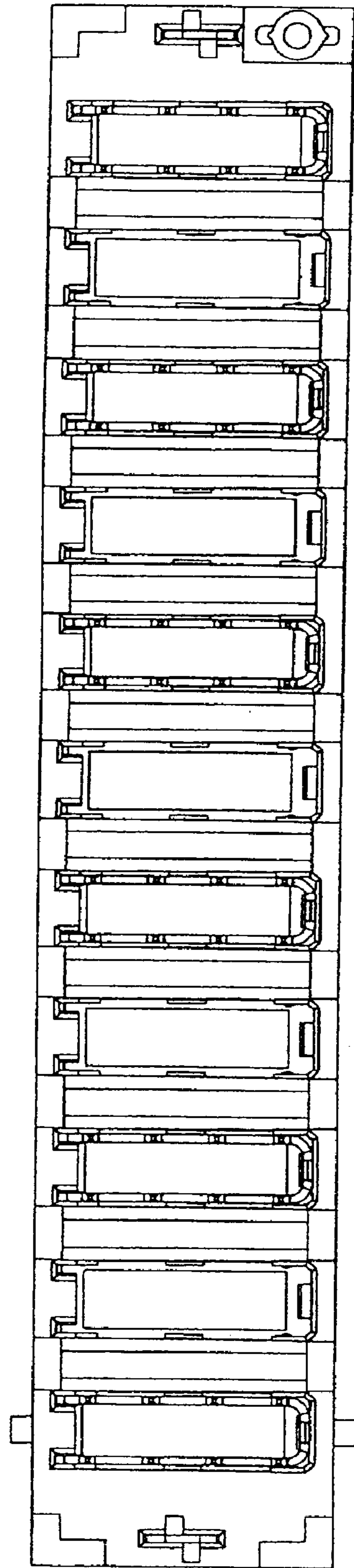

FIG. 3

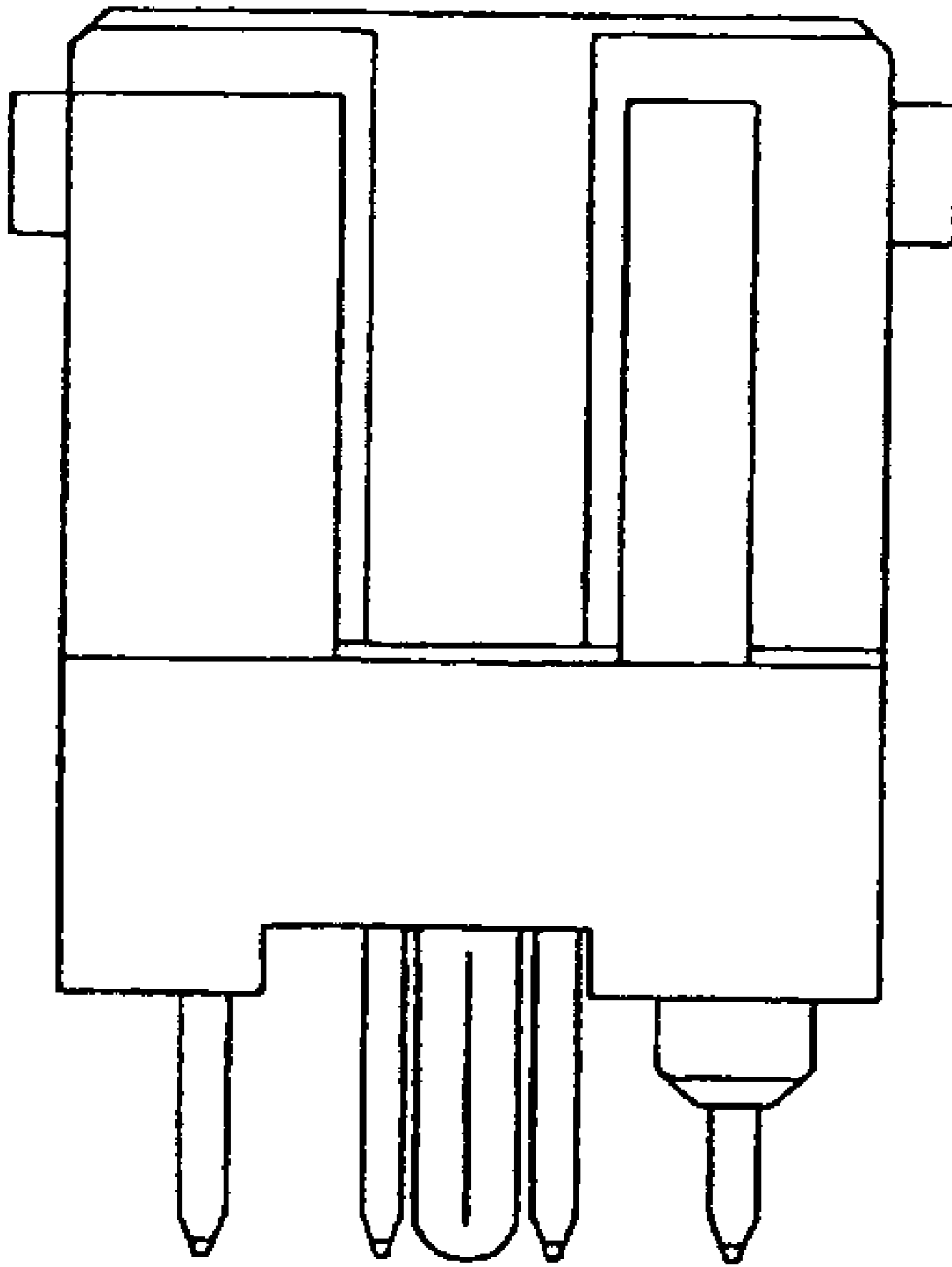

FIG. 4

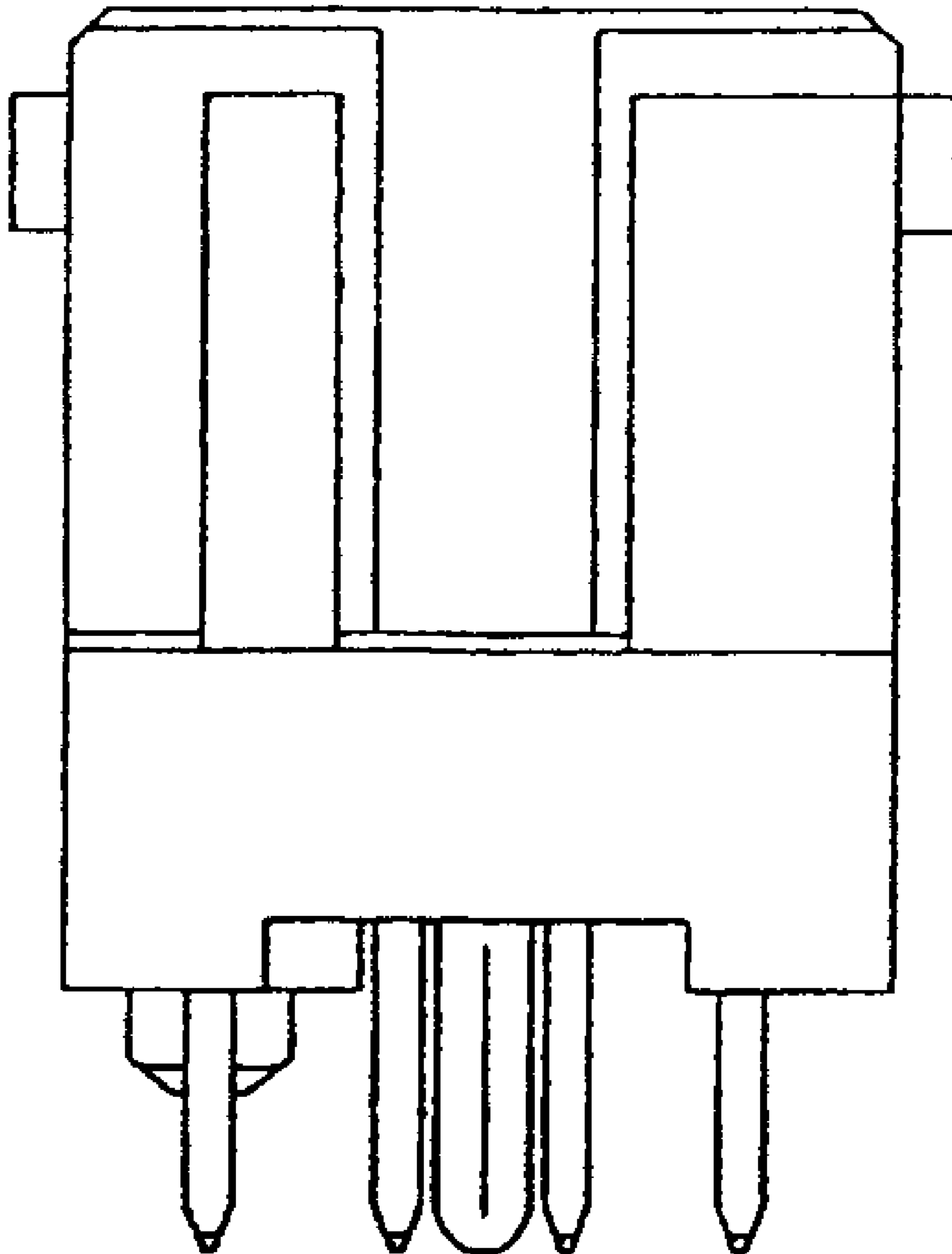

FIG. 5

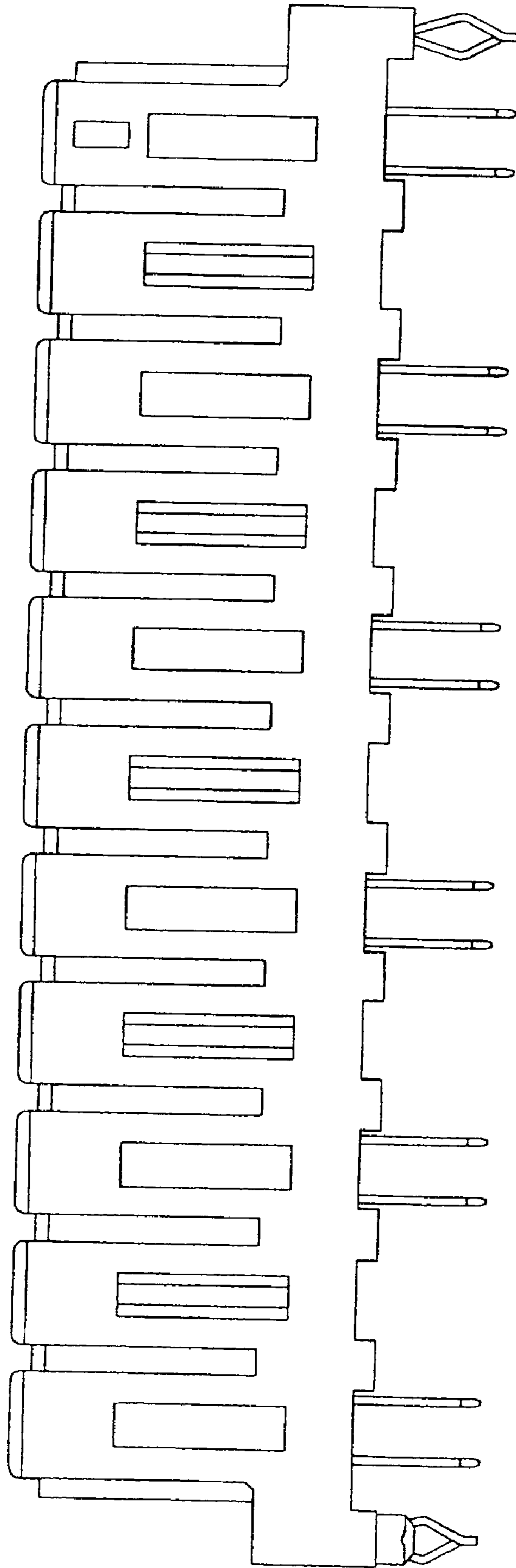

FIG. 6

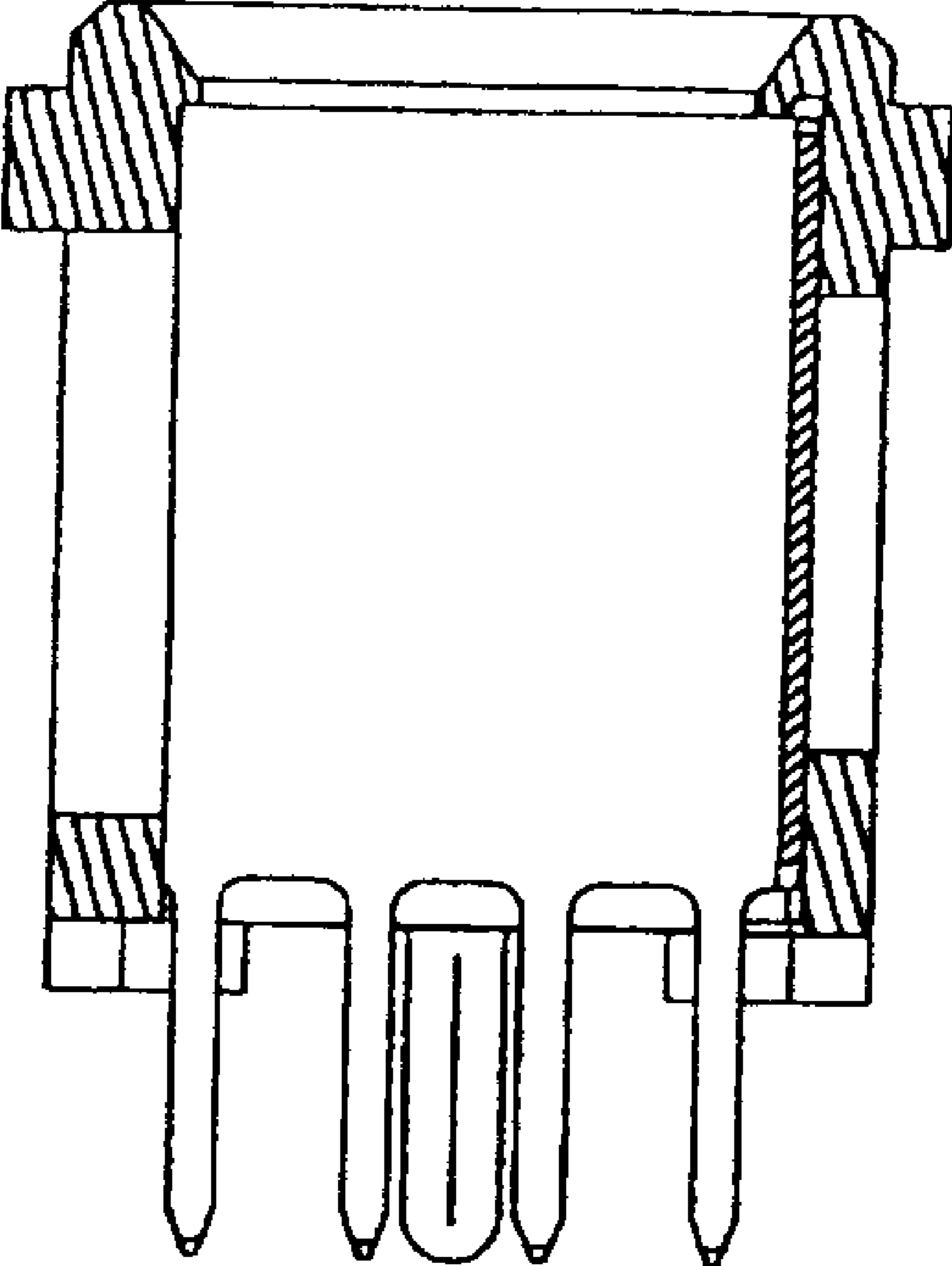

FIG. 7

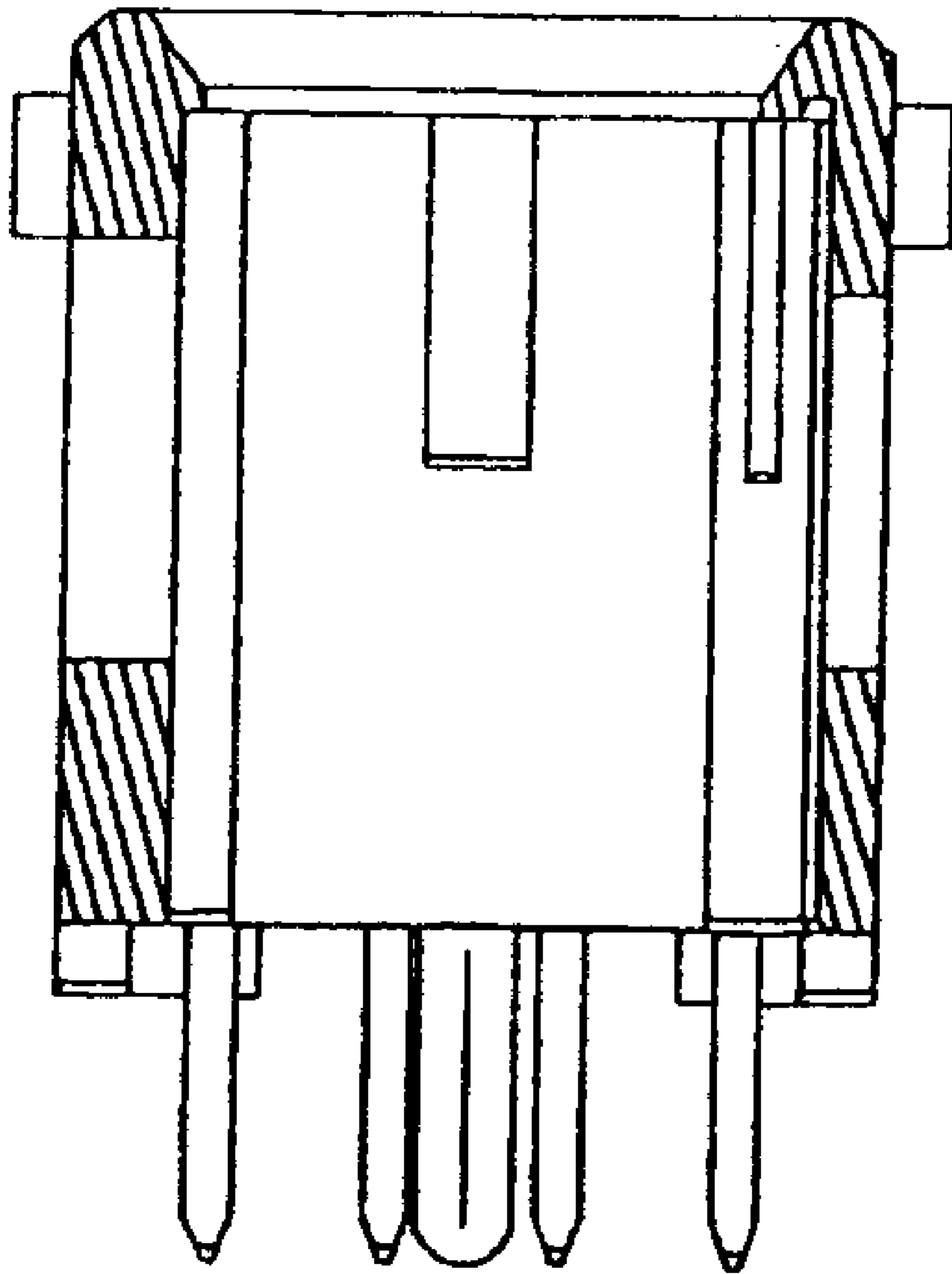

FIG. 8

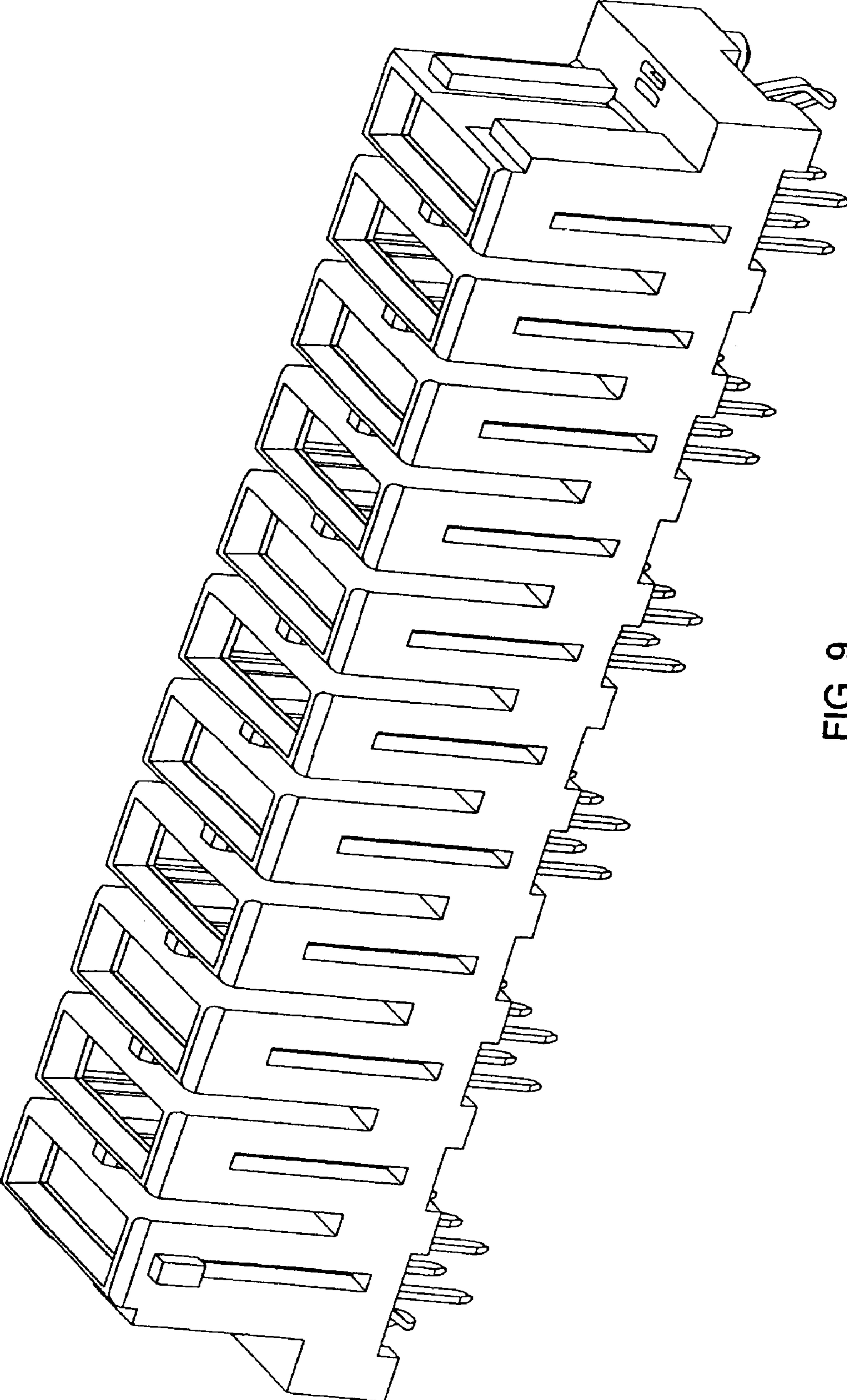

FIG. 9