



US00D517740S

(12) **United States Design Patent**
Kalaam et al.

(10) **Patent No.: US D517,740 S**
(45) **Date of Patent: ** Mar. 21, 2006**

(54) **HELMET**

(75) Inventors: **Shaik Kalaam**, Nepean (CA); **Richard L'Abbe**, Gloucester (CA); **Aristidis Makris**, Nepean (CA); **Justin Myles**, Carlsbad Springs (CA); **Geoffrey Fisher**, Ottawa (CA)

(73) Assignee: **Med-Eng Systems, Inc.**, Ottawa (CA)

(**) Term: **14 Years**

(21) Appl. No.: **29/164,743**

(22) Filed: **Jul. 30, 2002**

Related U.S. Application Data

(62) Division of application No. 29/146,684, filed on Aug. 14, 2001, now Pat. No. Des. 475,812.

(51) **LOC (8) Cl.** **29-02**

(52) **U.S. Cl.** **D29/107**

(58) **Field of Classification Search** D29/102-109, D29/122; 2/410, 6.6, 6.7, 6.8, 411, 414, 415, 2/423, 424, 425, 457, 468, 6.5, 9
See application file for complete search history.

(56) **References Cited**

U.S. PATENT DOCUMENTS

D166,904 S	6/1952	Bridges	
3,034,131 A	5/1962	Lent	
D207,900 S	6/1967	Feldmann et al.	
3,345,641 A	10/1967	Jennings	
3,422,458 A	1/1969	Schueller	
D214,547 S	7/1969	Fisher	
D215,137 S	9/1969	Fisher	
D215,684 S	10/1969	Fisher	
D253,197 S	10/1979	Jarvinen	
D256,626 S	9/1980	Antonino	
4,475,248 A	* 10/1984	L'Abbe et al.	2/2.5
H7 H	1/1986	Martone	
D283,940 S	5/1986	Bally	
4,639,944 A	2/1987	Lashley et al.	
4,677,696 A	7/1987	Tanaka	
4,901,370 A	2/1990	Suda	

4,925,133 A	5/1990	Wurst et al.
D320,475 S	10/1991	Jeter, Jr.
5,230,101 A	7/1993	Hedges et al.
5,239,706 A	8/1993	Stevenson

(Continued)

FOREIGN PATENT DOCUMENTS

CA 1178752 12/1984

OTHER PUBLICATIONS

- (1) Med-Eng Systems Inc., "EOD/IEDD, Suit and Helmet Protective Systems".
- (2) 1993 Safeco EOD, Incorporated, "Explosive Ordnance Disposal Suit".
- (3) American Body Armor, "Explosive Ordnance Disposal".
- (4) Med-Eng Systems Inc., "EOR-2 Plus Seach Suit".
- (5) Maavarim Civil Engineering Ltd., "Danger Mines!".
- (6) Safeco EOD, Incorporated, "PA-915 Explosive Ordnance Disposal Search Suit".
- (7) Protech Armored Products, "Protech EOD Protection".
- (8) Belgium Security Systems SC, "Protection Search Suit".
- (9) Oct. 1977—Med-Eng Systems Inc., "EOD-7B® Explosive Disposal Suit".

Primary Examiner—Ruth McInroy

(74) *Attorney, Agent, or Firm*—Wood, Phillips, Katz, Clark & Mortimer

(57) **CLAIM**

The ornamental design for a helmet, as shown and described.

DESCRIPTION

FIG. 1 is a front and right side perspective view of a helmet showing our new design;
 FIG. 2 is a front perspective view thereof;
 FIG. 3 is a left and bottom perspective view thereof;
 FIG. 4 is a rear perspective view thereof;
 FIG. 5 is a top perspective view thereof; and,
 FIG. 6 is a bottom perspective view thereof, depicting only part of the hose shown in the preceding figures.
 The details shown in broken lines form no part of the claimed design.

1 Claim, 4 Drawing Sheets

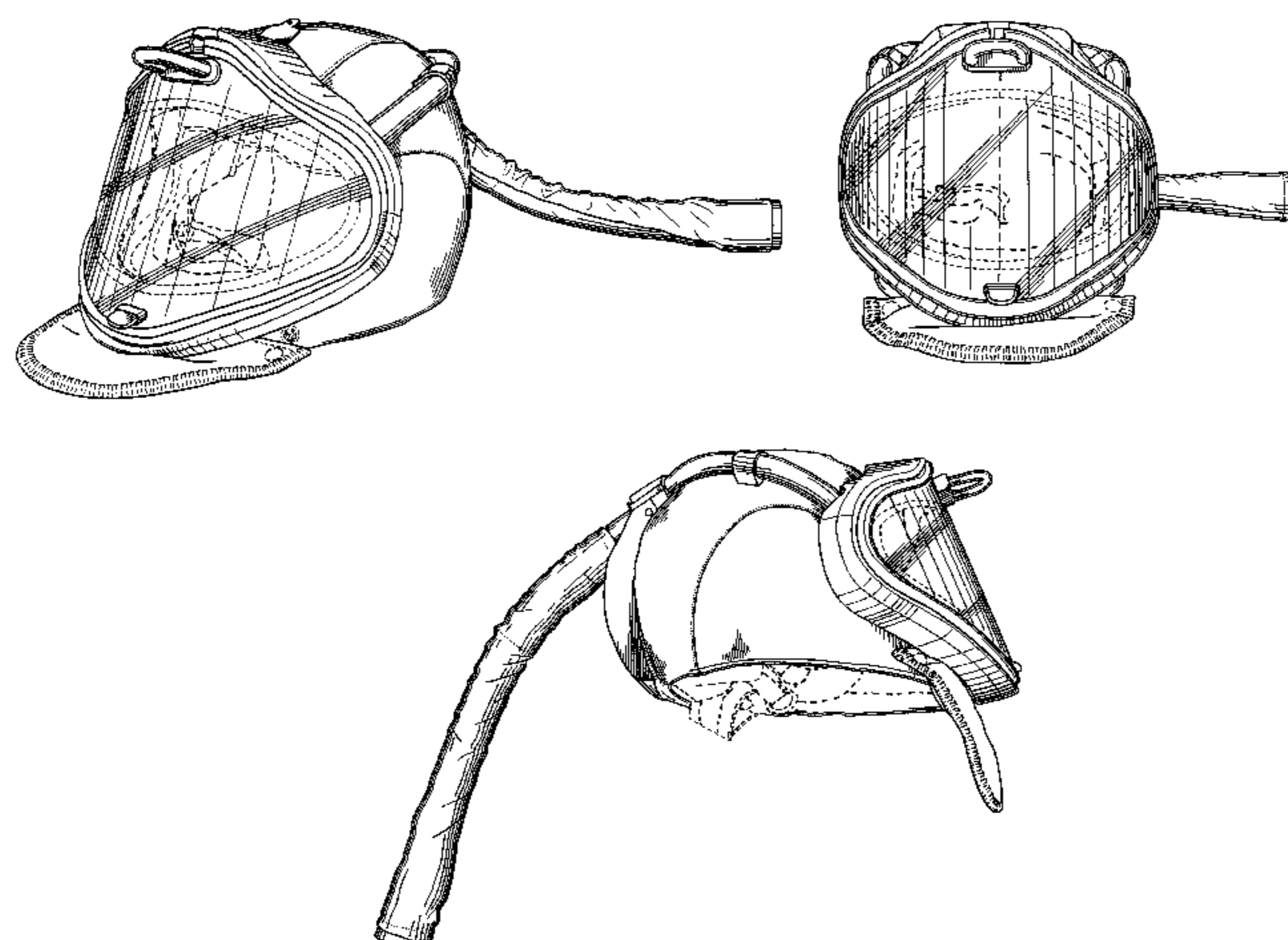

US D517,740 S

Page 2

U.S. PATENT DOCUMENTS					
			D402,415 S	* 12/1998	Widgery D29/107
			D403,487 S	1/1999	Crupi et al.
5,274,854 A	1/1994	Wenner et al.	5,946,719 A	* 9/1999	Crupi et al. 2/6.5
5,421,326 A	6/1995	Rankin et al.	D429,384 S	8/2000	Crupi et al.
5,448,780 A	9/1995	Gath	D435,697 S	12/2000	James et al.
D369,454 S	5/1996	Olsen	D441,917 S	5/2001	L'Abbe et al.
5,704,071 A	1/1998	Barclay et al.	6,591,430 B1	* 7/2003	Sledge 2/468
5,718,003 A	2/1998	Gwinn			
D392,437 S	3/1998	Duval			
D397,519 S	* 8/1998	Crupi et al. D29/107			* cited by examiner

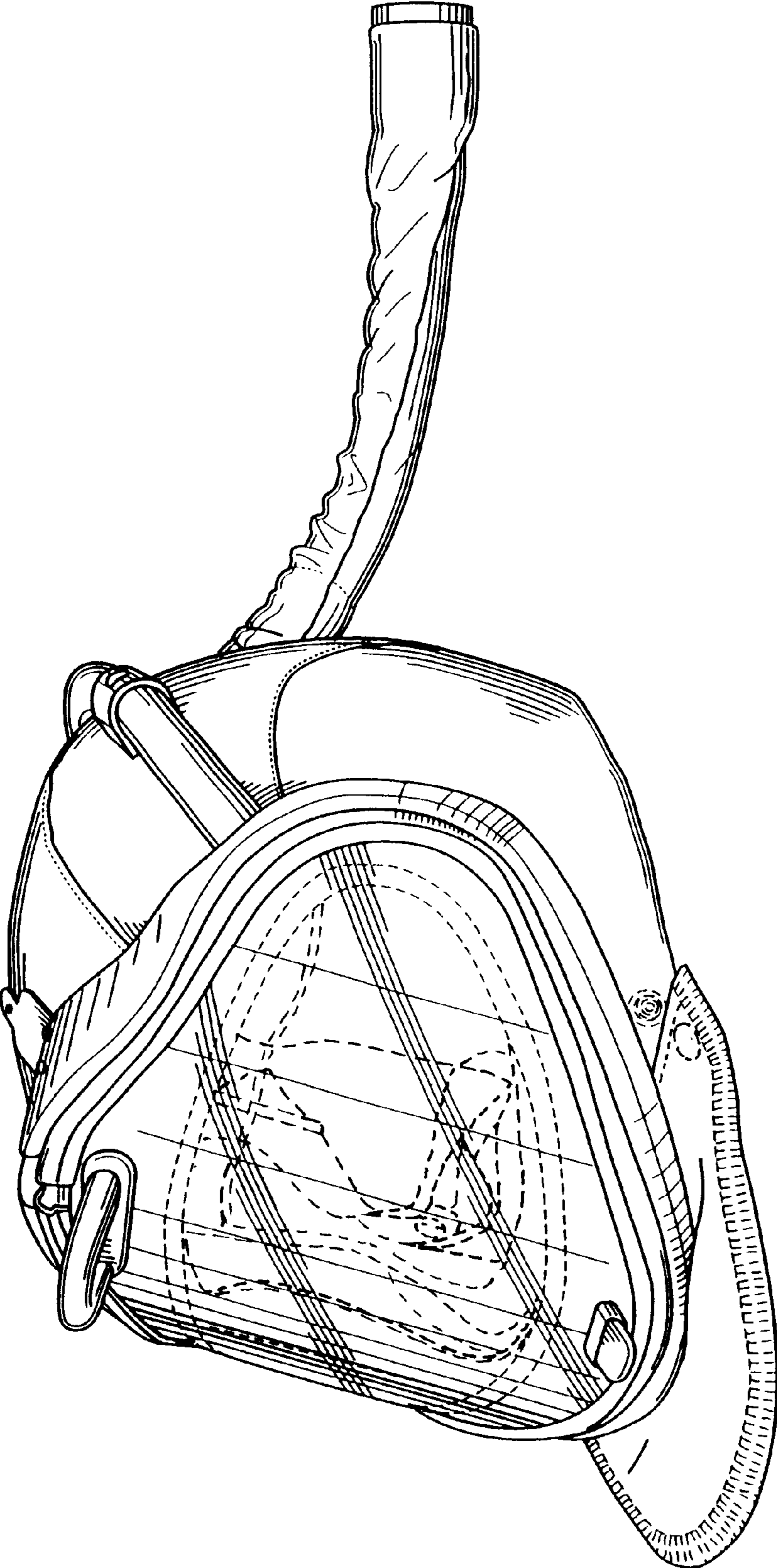

FIG. 1

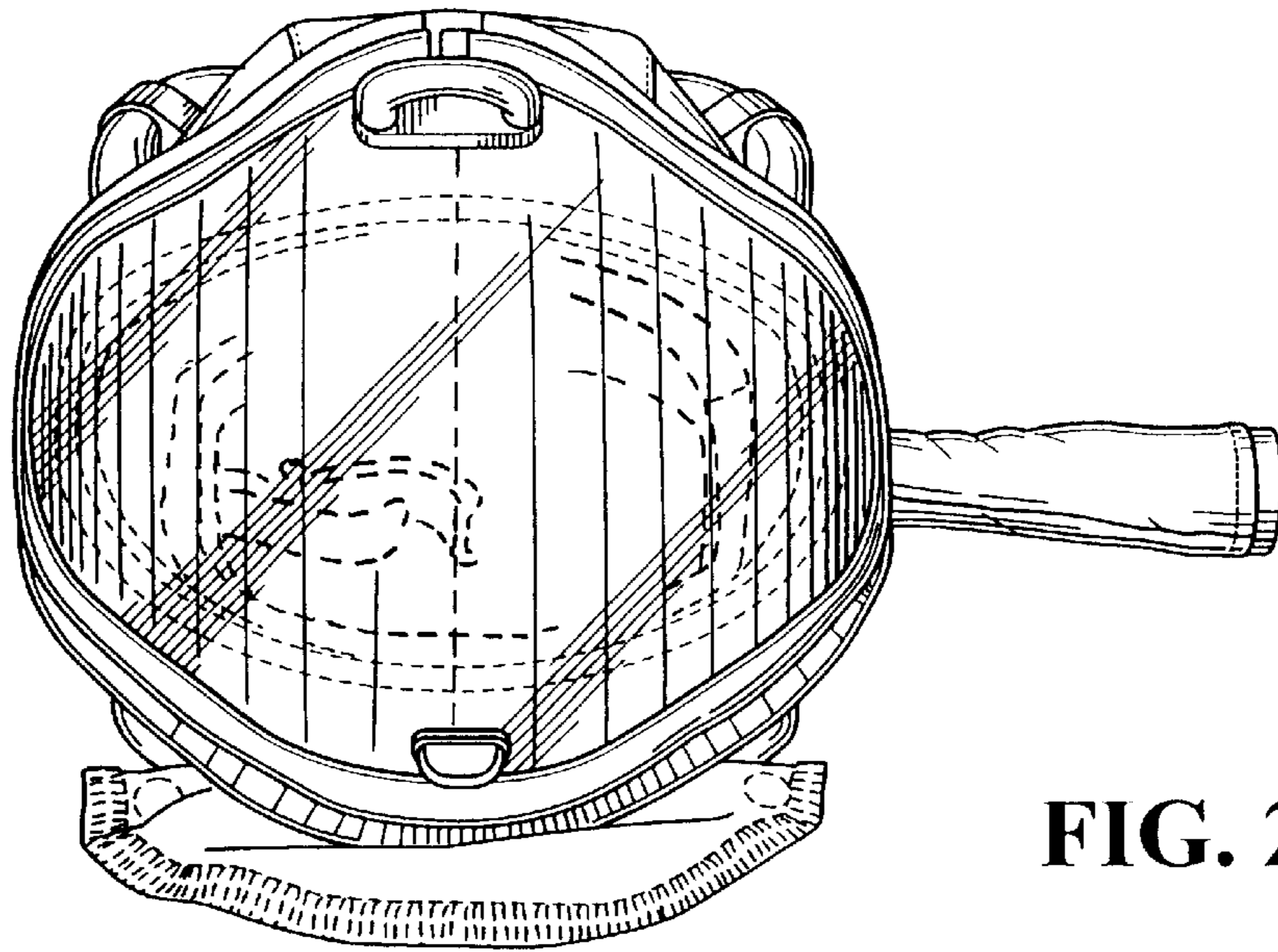

FIG. 2

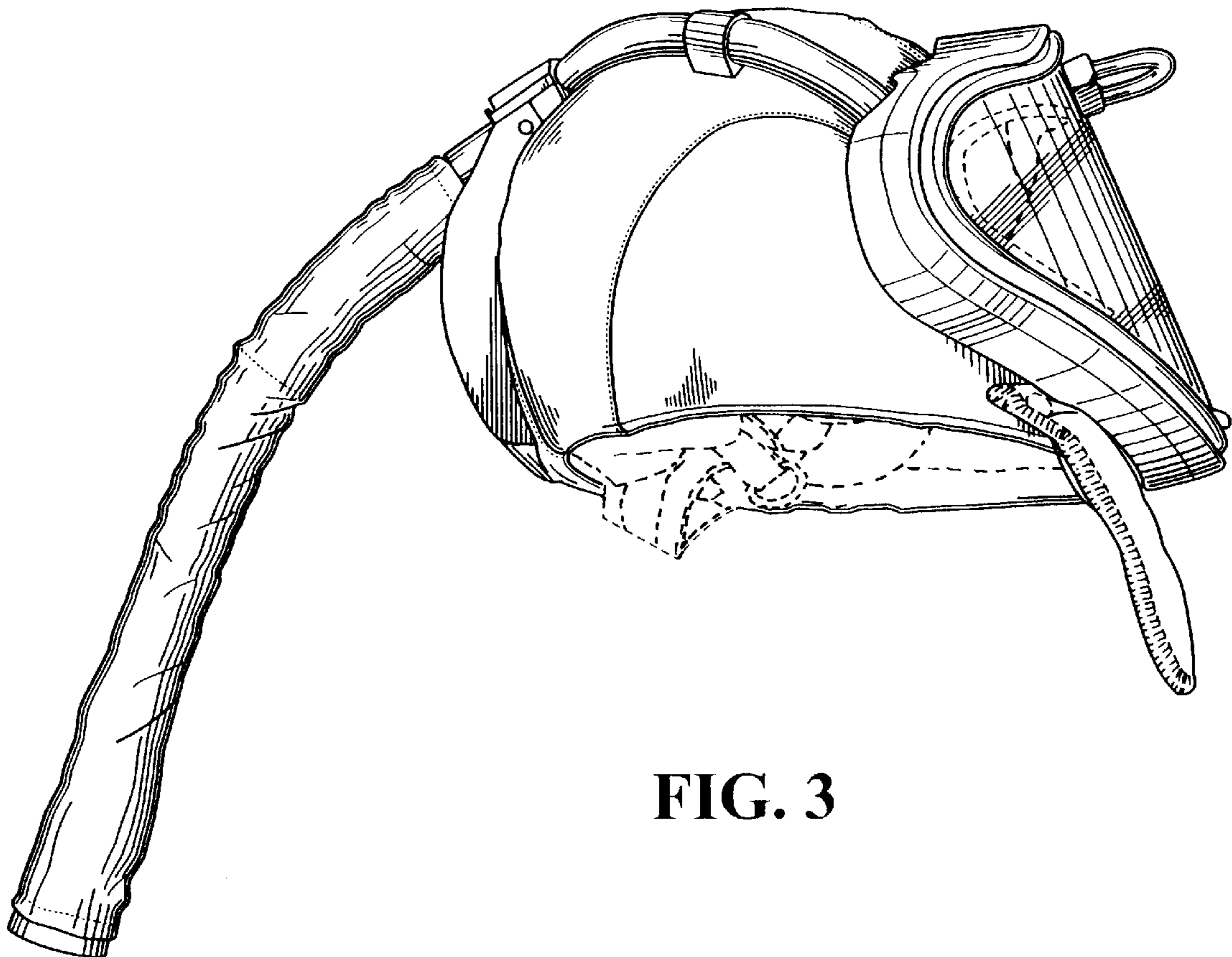

FIG. 3

FIG. 4

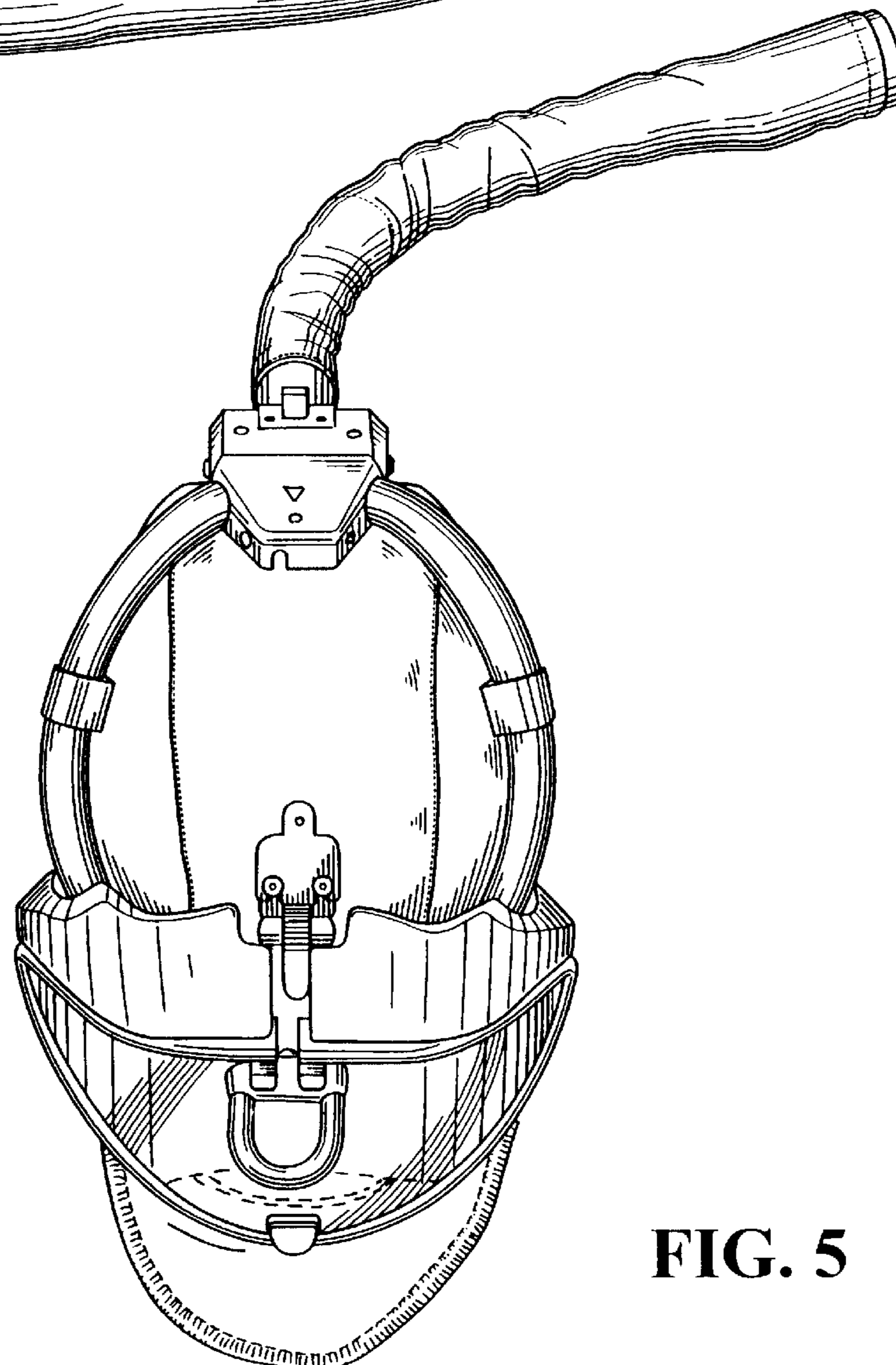
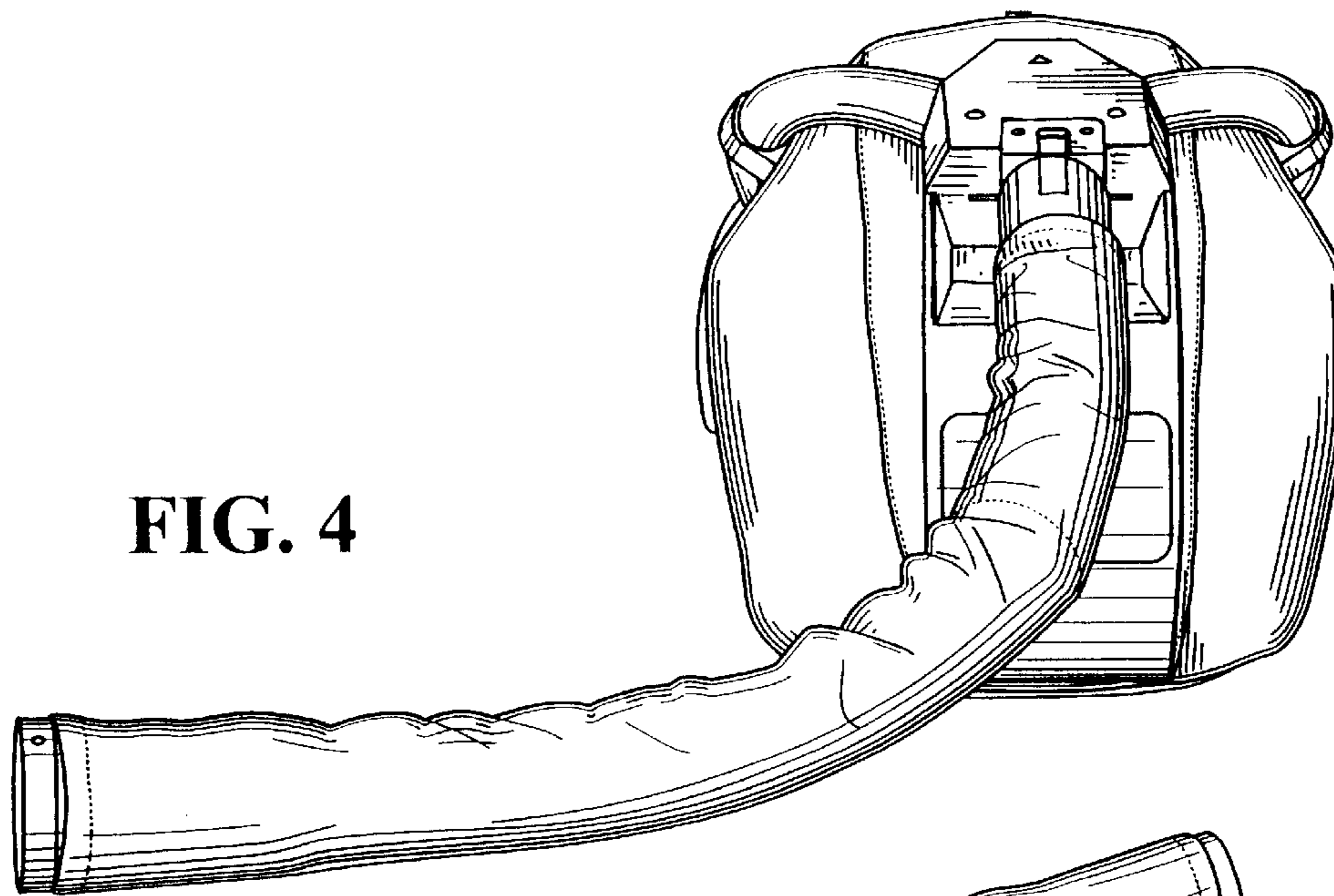

FIG. 5

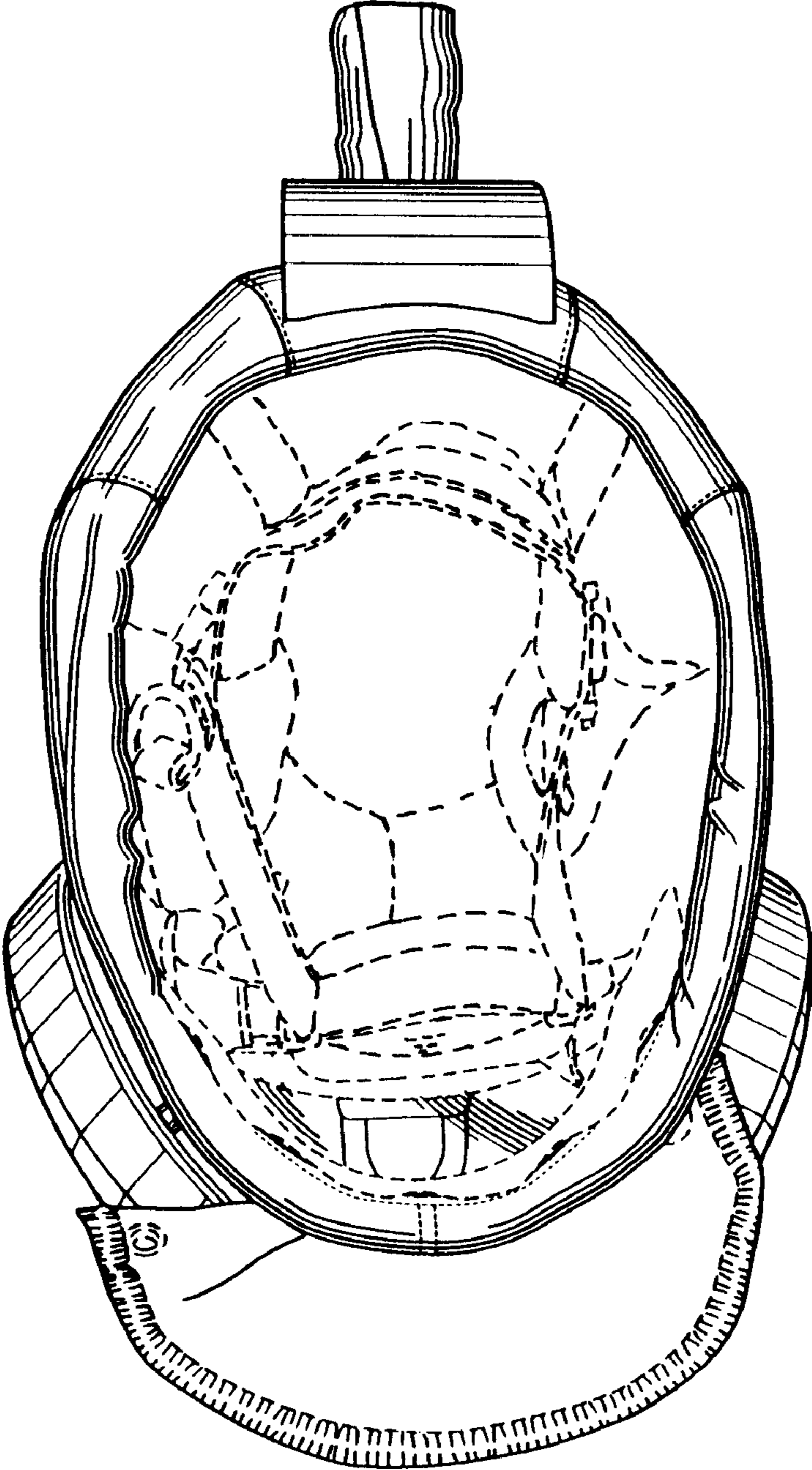

FIG. 6