



US00D517692S

(12) **United States Design Patent** (10) **Patent No.:** **US D517,692 S**
Weber et al. (45) **Date of Patent:** **** *Mar. 21, 2006**

- (54) **TAMPON APPLICATOR BARREL**
- (75) Inventors: **Susanne Weber**, New York, NY (US);
Mario Turchi, Tenafly, NJ (US)
- (73) Assignee: **Playtex Products, Inc.**, Westport, CT (US)
- (*) Notice: This patent is subject to a terminal disclaimer.
- (**) Term: **14 Years**
- (21) Appl. No.: **29/201,235**
- (22) Filed: **Mar. 11, 2004**
- (51) **LOC (8) Cl.** **24-02**
- (52) **U.S. Cl.** **D24/141**
- (58) **Field of Classification Search** D24/141,
D24/135, 130; 604/15, 902, 18, 17, 11, 16,
604/39, 41, 57, 59, 14; 606/191
See application file for complete search history.

(56) **References Cited**

U.S. PATENT DOCUMENTS

3,628,533 A	12/1971	Loyer	128/263
D250,663 S	12/1978	Koch et al.	D24/99
4,428,370 A *	1/1984	Keely	604/14
4,508,531 A	4/1985	Whitehead	604/14
4,536,178 A	8/1985	Lichstein et al.	604/15
D492,033 S *	6/2004	Jarmon et al.	D24/141
2003/0105421 A1 *	6/2003	Jarmon et al.	604/11

* cited by examiner

Primary Examiner—Ian Simmons
(74) *Attorney, Agent, or Firm*—Ohlandt, Greeley, Ruggiero & Perle, L.L.P.

(57) **CLAIM**

The ornamental design for a tampon applicator barrel, as shown and described.

DESCRIPTION

FIG. 1 is a front perspective view of a tampon applicator barrel according to the present invention;
FIG. 2 is a rear perspective view of the tampon applicator barrel of FIG. 1;
FIG. 3 is a top view of the tampon applicator barrel of FIG. 1;
FIG. 4 is the tampon applicator barrel of FIG. 3 rotated by 180 degrees about a longitudinal axis;
FIG. 5 is the tampon applicator barrel of FIG. 3 rotated by 90 degrees about a longitudinal axis;
FIG. 6 is the tampon applicator barrel of FIG. 3 rotated by 270 degrees about a longitudinal axis;
FIG. 7 is a front end view of the tampon applicator barrel of FIG. 1; and,
FIG. 8 is a rear end view of the tampon applicator barrel of FIG. 1.

The broken line showing is for illustrative purposes only and forms no part of the claimed design.

1 Claim, 5 Drawing Sheets

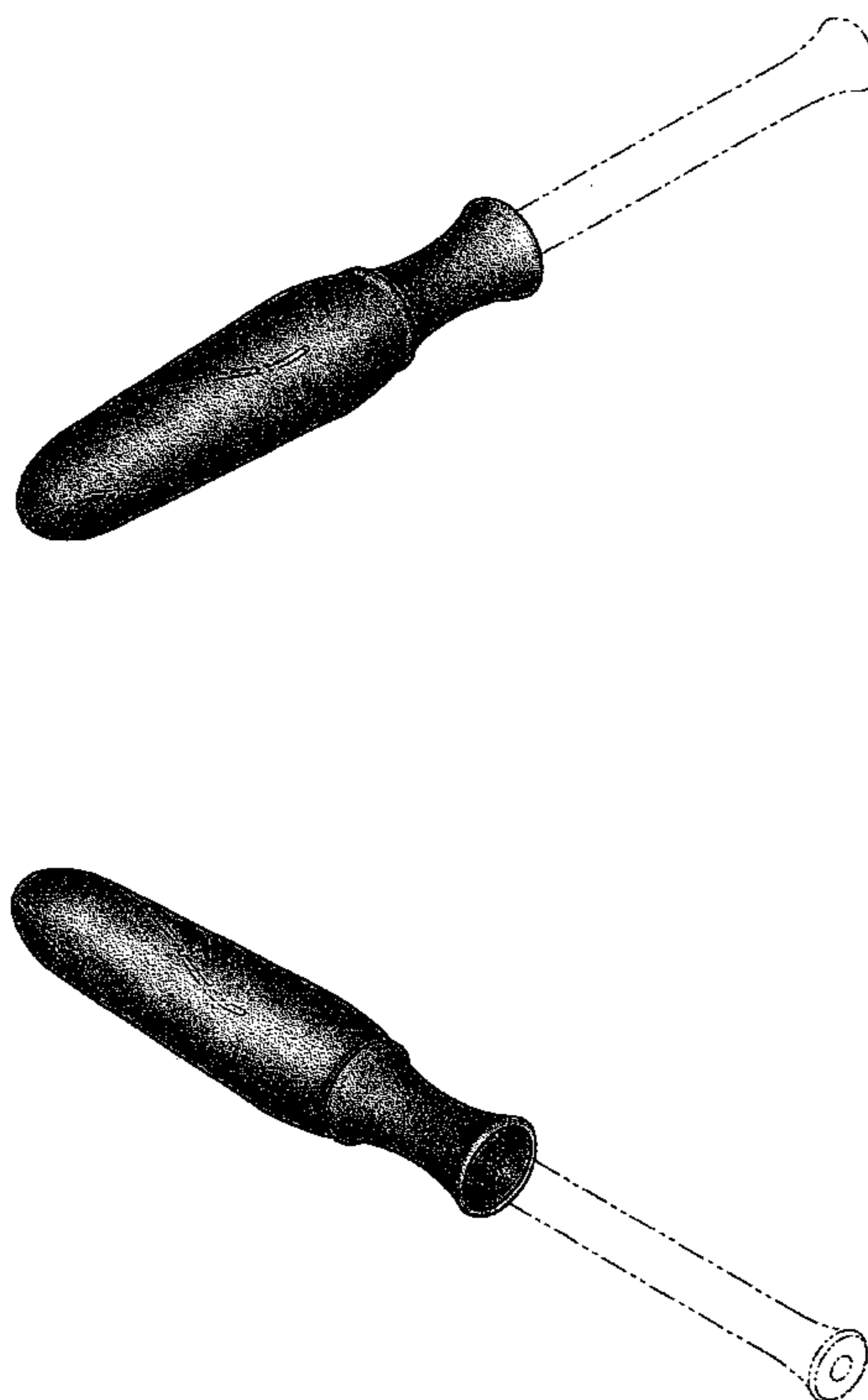

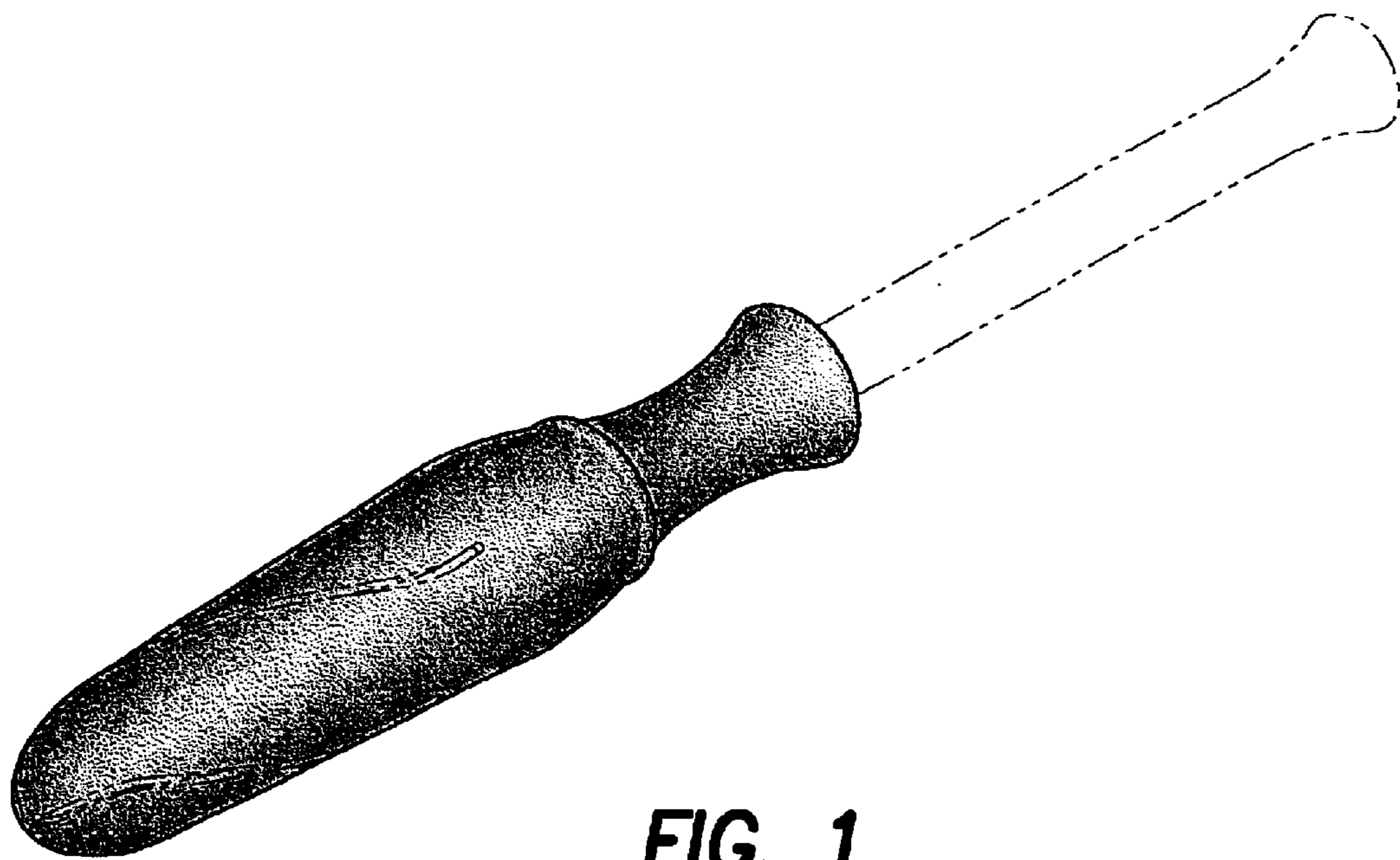

FIG. 1

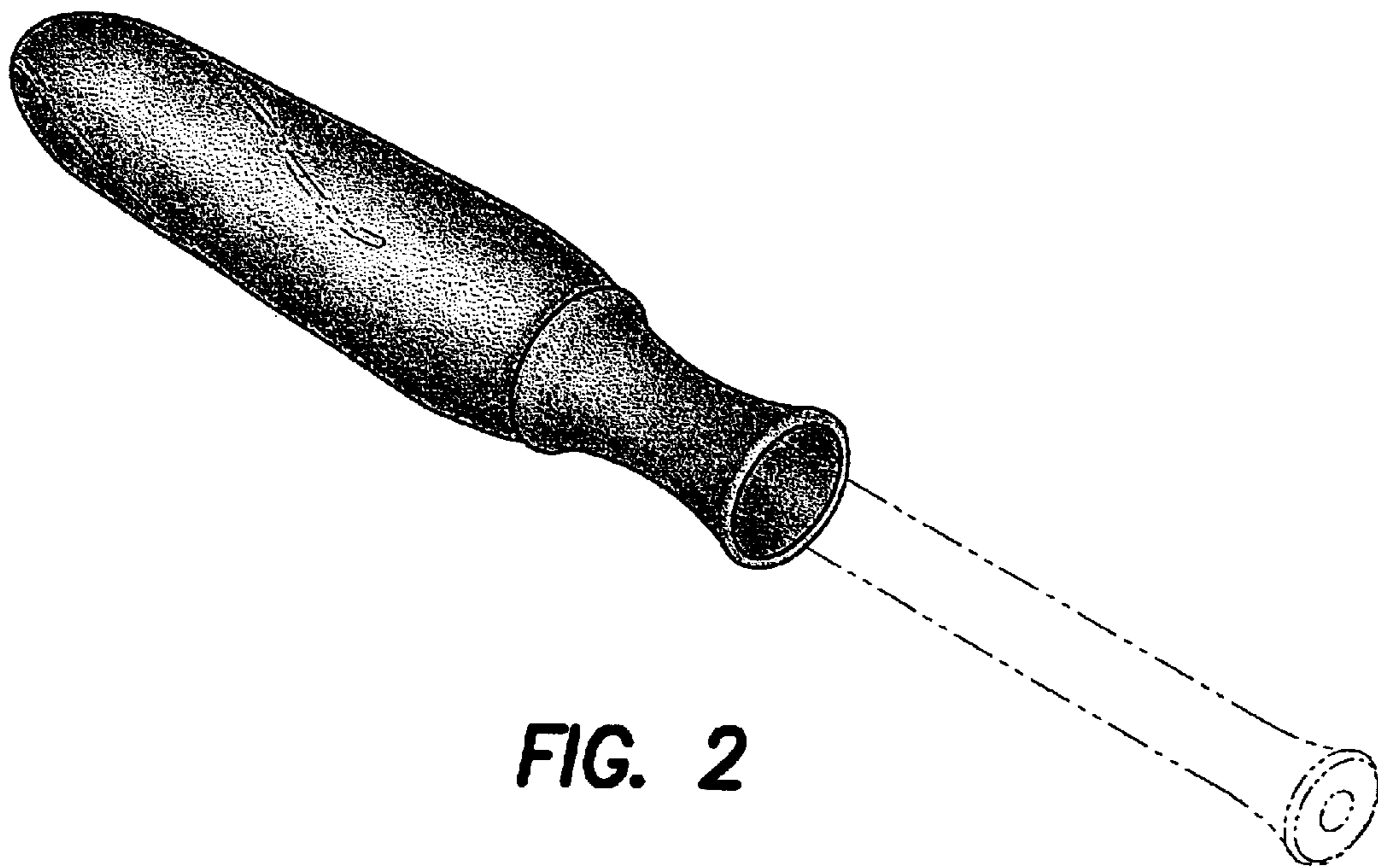

FIG. 3

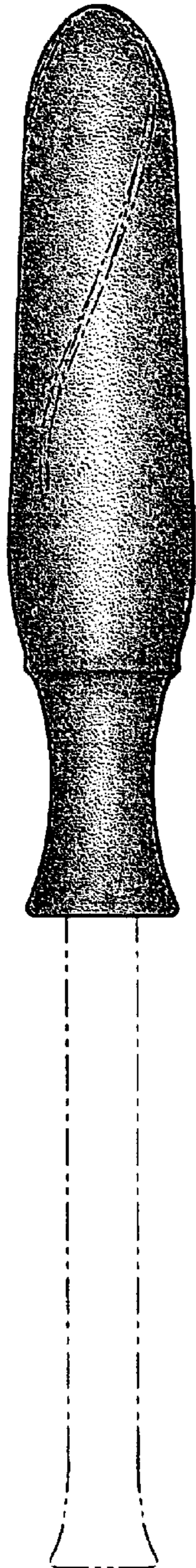

FIG. 4

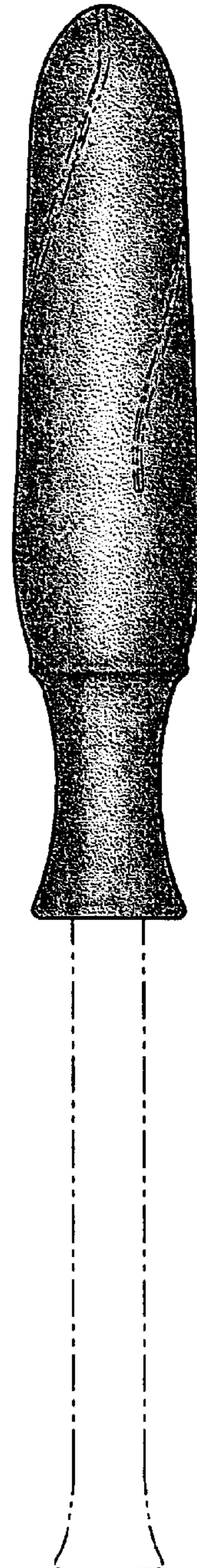

FIG. 5

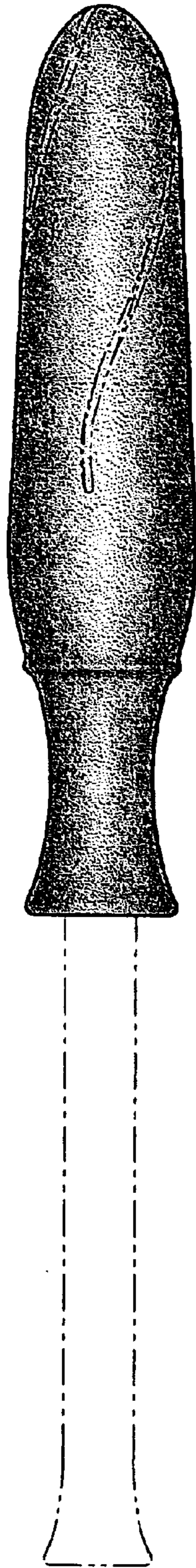

FIG. 6

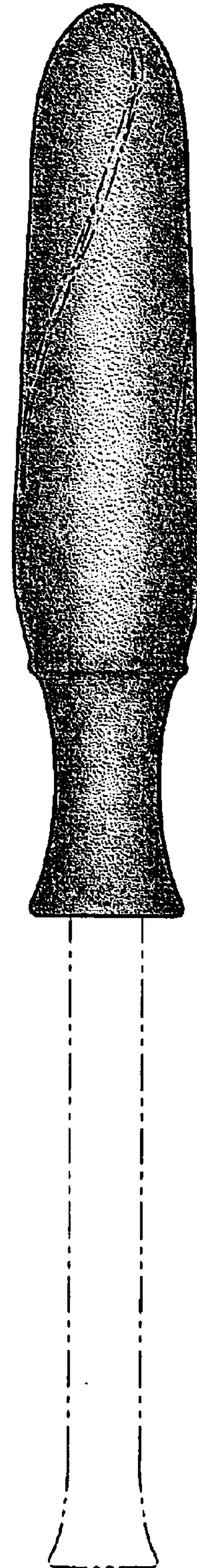



FIG. 7



FIG. 8