



US00D517630S

(12) **United States Design Patent**
Wickstrom

(10) **Patent No.:** **US D517,630 S**

(45) **Date of Patent:** **** Mar. 21, 2006**

(54) **SKIM BOARD**

(76) Inventor: **Philip A. Wickstrom**, 144 Paldao
Acres, Wauchula, FL (US) 33873

(**) Term: **14 Years**

(21) Appl. No.: **29/209,492**

(22) Filed: **Jul. 15, 2004**

(51) **LOC (8) Cl.** **21-02**

(52) **U.S. Cl.** **D21/769; D21/760**

(58) **Field of Classification Search** D21/769,
D21/770, 760, 765, 801, 803, 809, 766, 421;
D12/303, 307, 6; 441/56, 65, 74, 75, 79
See application file for complete search history.

(56) **References Cited**

U.S. PATENT DOCUMENTS

3,160,897	A	*	12/1964	Kelly, Jr.	441/74
4,028,761	A	*	6/1977	Taylor	441/65
D260,106	S	*	8/1981	Peritz	D21/769
4,619,619	A	*	10/1986	Muse, Jr.	441/65
4,629,434	A	*	12/1986	Monreal	441/65
4,883,436	A	*	11/1989	Oakland	441/65
5,514,017	A	*	5/1996	Chimiak	441/65
D392,710	S	*	3/1998	del Paso	D21/769

D398,693 S * 9/1998 Drinkwine D21/801
D503,763 S * 4/2005 Morgan D21/769

* cited by examiner

Primary Examiner—Lucy Lieberman

(74) *Attorney, Agent, or Firm*—Gifford, Krass, Groh
Sprinkle, Anderson & Citkowski, P.C.

(57) **CLAIM**

The ornamental design for a skim board, as shown and described.

DESCRIPTION

FIG. 1 is a perspective view of the skim board showing my new design;

FIG. 2 is a top plan view of the skim board seen in FIG. 1;
FIG. 3 is a bottom view of the skim board seen in FIGS. 1 and 2;

FIG. 4 is a center cross-sectional view of the skim board taken on line 4—4 in FIG. 2;

FIG. 5 is an elevation from one side of the skim board with the opposite side being a mirror image thereof;

FIG. 6 is a sectional view taken on line 6—6 in FIG. 5;

FIG. 7 is a rear elevation of the skim board shown in the prior figures; and,

FIG. 8 is a front elevation of the skim board shown in the prior figures.

FIGS. 4 through 8 are shown on an enlarged scale.

1 Claim, 2 Drawing Sheets

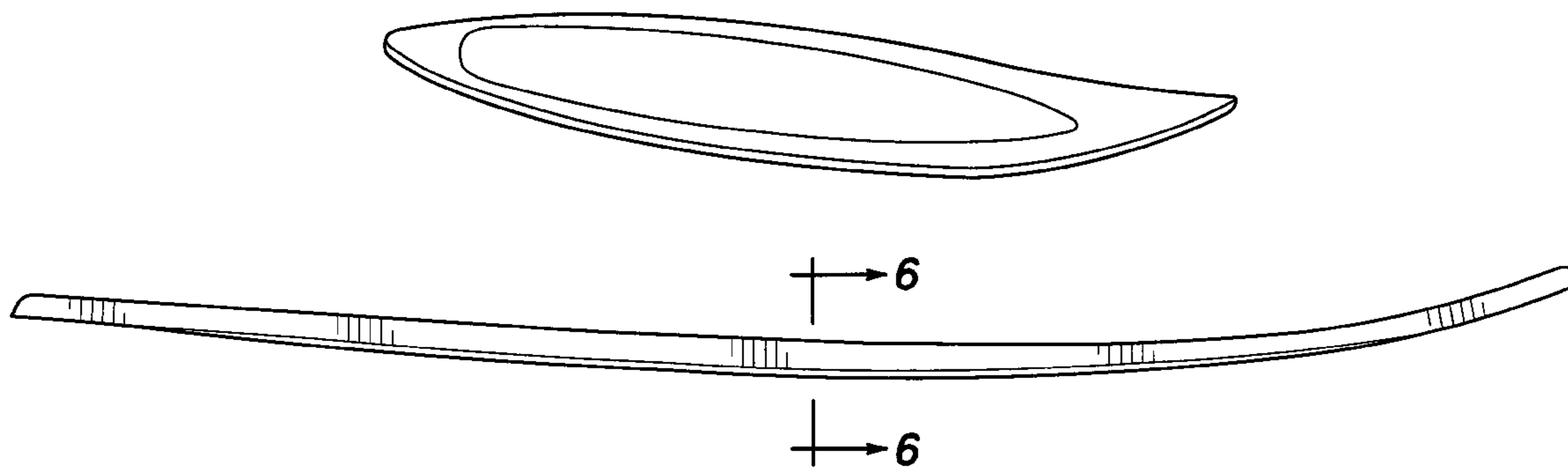

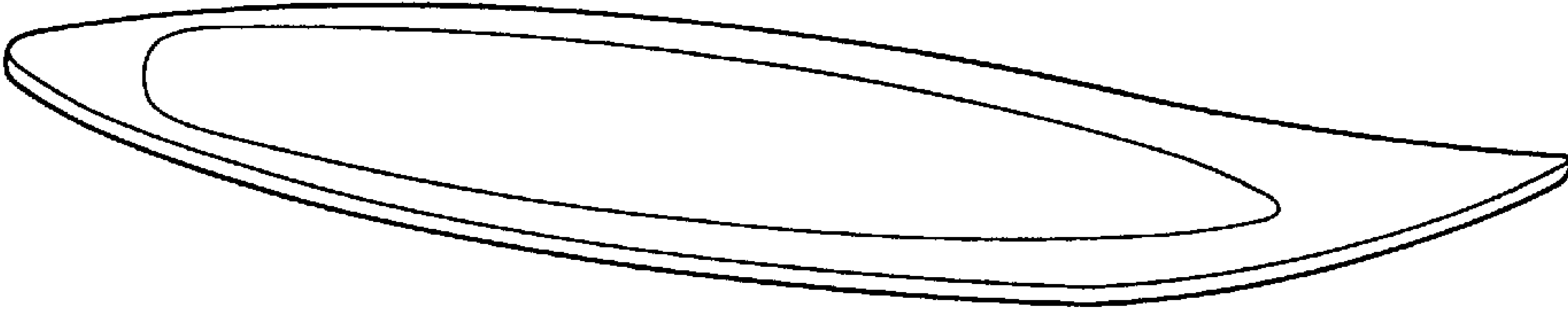

Fig-1

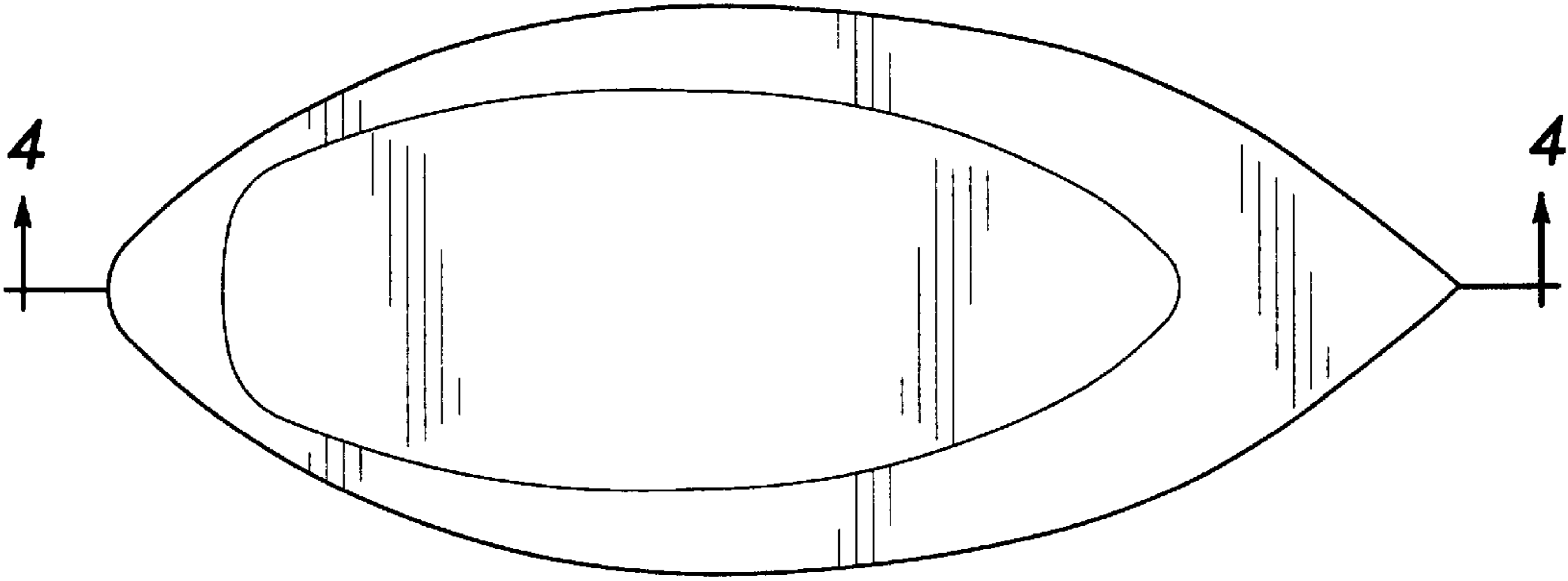

Fig-2

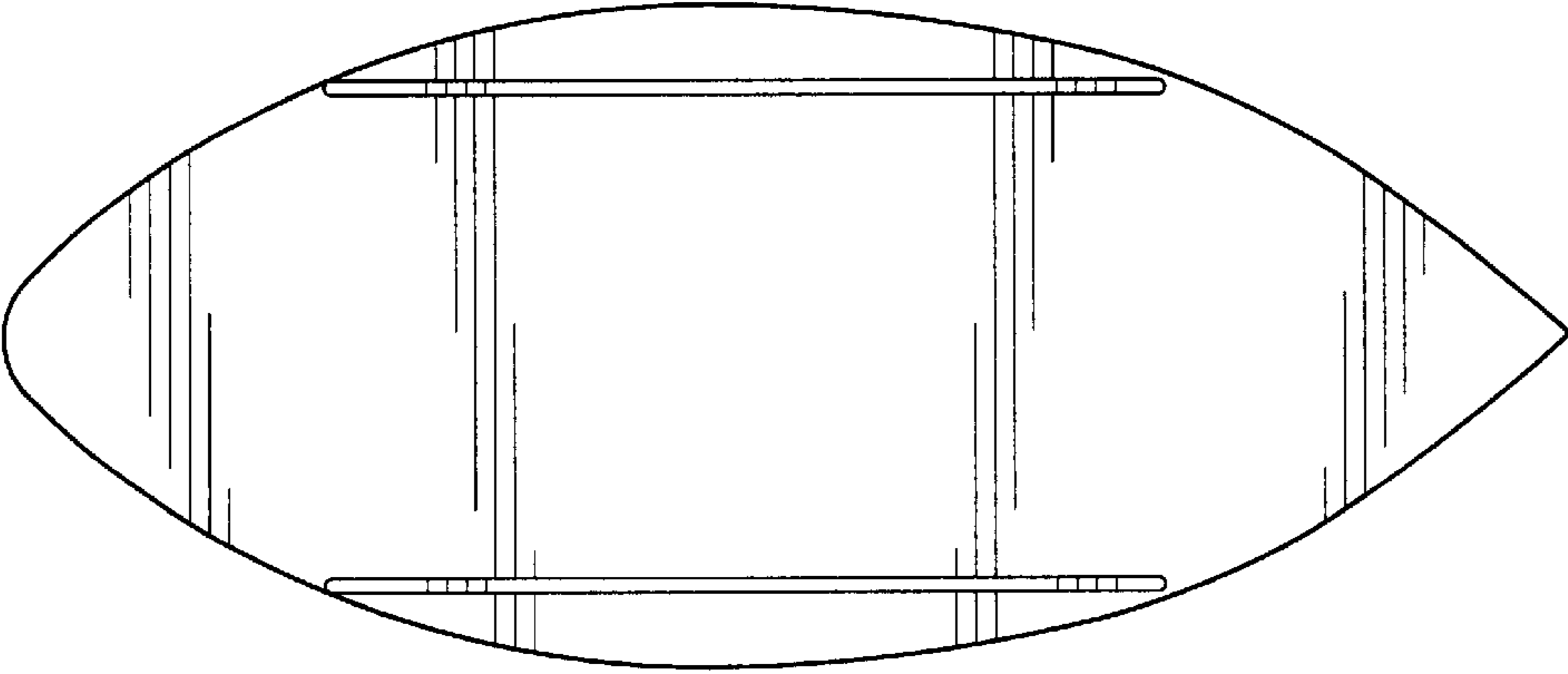

Fig-3

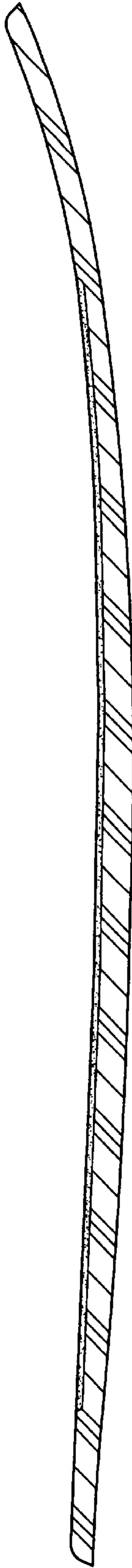

Fig-4

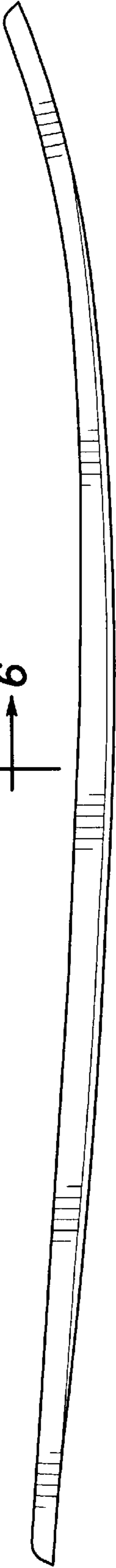

Fig-5



Fig-6

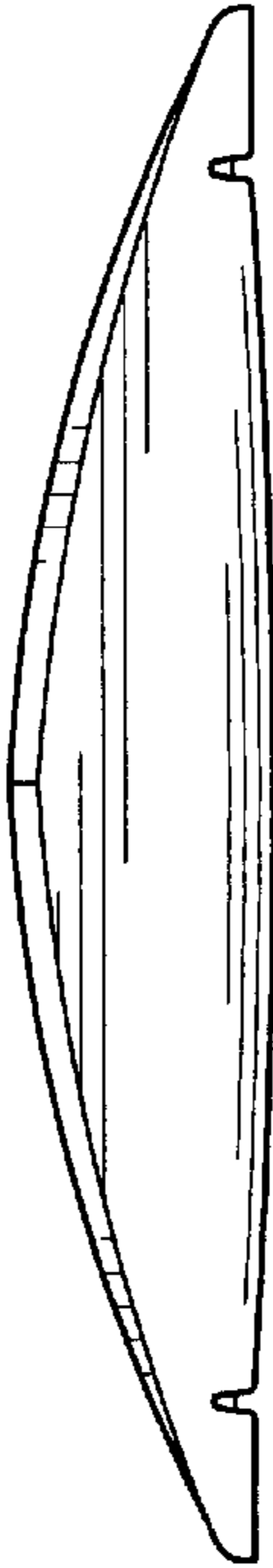

Fig-8



Fig-7