



US00D517622S

(12) **United States Design Patent** (10) **Patent No.:** **US D517,622 S**
Barouh (45) **Date of Patent:** **** *Mar. 21, 2006**

(54) **GOLF TEE WITH BALL ELEVATING MEMBERS**

FOREIGN PATENT DOCUMENTS

(75) Inventor: **Victor Barouh**, Old Westbury, NY (US)
(73) Assignee: **Barouh Eaton Allen Corp.**, Brooklyn, NY (US)

AU 2003100408 A4 * 8/2003
GB 2 048 082 A 12/1980
JP 2004236901 A * 8/2004
JP 2004344250 A * 12/2004
WO WO 93/06897 A1 * 4/1993

(*) Notice: This patent is subject to a terminal disclaimer.

OTHER PUBLICATIONS

(**) Term: **14 Years**

U.S. Appl. No. 29/187,404—filed Aug. 1, 2003.
U.S. Appl. No. 11/071,228—filed Mar. 4, 2005.
U.S. Appl. No. 29/224,564—filed Mar. 4, 2005.

(21) Appl. No.: **29/224,565**

Primary Examiner—Catherine Tuttle
(74) *Attorney, Agent, or Firm*—Dinesh Agarwal, P.C.

(22) Filed: **Mar. 4, 2005**

(51) **LOC (8) Cl.** **21-02**

(52) **U.S. Cl.** **D21/718**

(58) **Field of Classification Search** D21/715–721,
D21/789–796; 473/386–403

(57) **CLAIM**

See application file for complete search history.

The ornamental design for a golf tee with ball elevating members, as shown and described.

DESCRIPTION

(56) **References Cited**

U.S. PATENT DOCUMENTS

1,553,561	A	9/1925	Scott	
1,596,110	A	8/1926	Lynch	
1,597,740	A	8/1926	Thompson	
1,625,911	A	4/1927	Richards	
1,638,448	A	8/1927	Manson	
1,936,625	A	11/1933	Goldman	
1,959,347	A	5/1934	Czizhos	
2,700,788	A	2/1955	Hennelly	
3,041,071	A	6/1962	Fialon	
3,079,158	A	2/1963	Finn et al.	
3,114,557	A	12/1963	Cabot	
3,203,700	A	8/1965	Antonious	
3,408,079	A	10/1968	Kirikos	
3,883,144	A	5/1975	Lazow	
3,899,179	A	8/1975	Vlach	
4,128,245	A	12/1978	Vlach	
4,516,773	A *	5/1985	Martin	473/391
4,544,159	A	10/1985	Sells	
D293,261	S	12/1987	Sadowski	
D306,194	S	2/1990	Sadowski	
5,052,689	A	10/1991	Lettrich	

FIG. 1 is a perspective view of a golf tee with ball elevating members showing my design;
FIG. 2 is a front elevational view of the golf tee with ball elevating members of FIG. 1, shown partially broken away at the lower end for ease of illustration;
FIG. 3 is a top plan view of the golf tee with ball elevating members of FIG. 1;
FIG. 4 is a rear elevational view of the golf tee with ball elevating members of FIG. 1;
FIG. 5 is a bottom plan view of the golf tee with ball elevating members of FIG. 1;
FIG. 6 is a left side view of the golf tee with ball elevating members of FIG. 1, the right side view being a mirror image thereof; and,
FIG. 7 is a perspective view of the golf tee with ball elevating members of FIG. 1, shown in use on a golf course. The matter shown in phantom lines in FIGS. 1, 2, and 7 is for illustrative purposes only and forms no part of the claimed design.

(Continued)

1 Claim, 3 Drawing Sheets

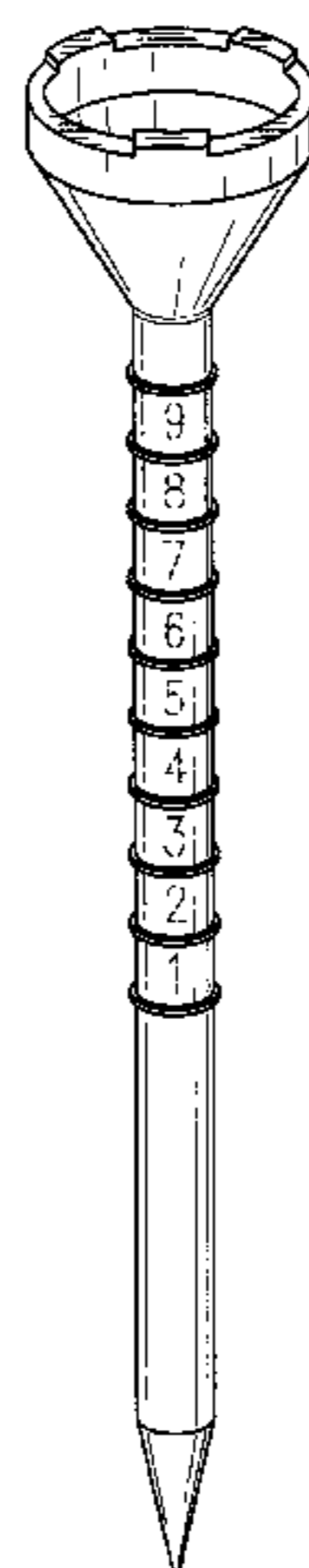

US D517,622 S

Page 2

U.S. PATENT DOCUMENTS

5,240,254 A	8/1993	Adlam	D411,276 S	6/1999	Rosenfeld	
D346,190 S	4/1994	Folker	D413,640 S	9/1999	Fearer, III	
D350,178 S	8/1994	Kristorich	6,017,282 A	1/2000	Stefonsky	
5,356,146 A	10/1994	Blosser	D428,954 S	8/2000	Tate	
D360,006 S	7/1995	Samples	6,475,107 B1	11/2002	Sand	
5,437,446 A	8/1995	Youngkin	D468,379 S	1/2003	Gan	
D370,041 S	5/1996	Thomas	6,729,977 B1 *	5/2004	Young et al.	473/398
5,569,102 A	10/1996	Karron	D492,374 S	6/2004	Barouh	
5,571,055 A	11/1996	Lewis et al.	2004/0152542 A1 *	8/2004	Blum et al.	473/400
5,672,122 A	9/1997	Strong	2005/0026726 A1	2/2005	Barouh	
5,720,677 A	2/1998	Rudduck	2005/0026727 A1	2/2005	Barouh	
5,890,976 A	4/1999	Anderson				

* cited by examiner

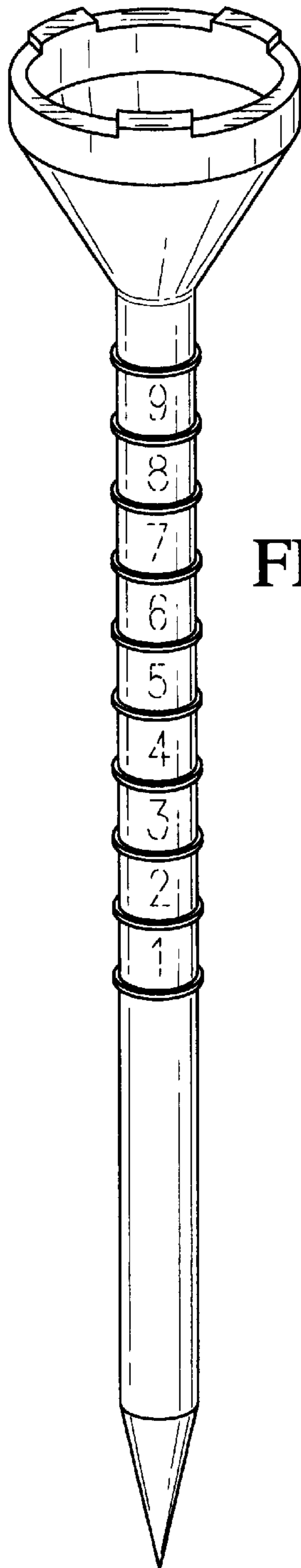

FIG. 1

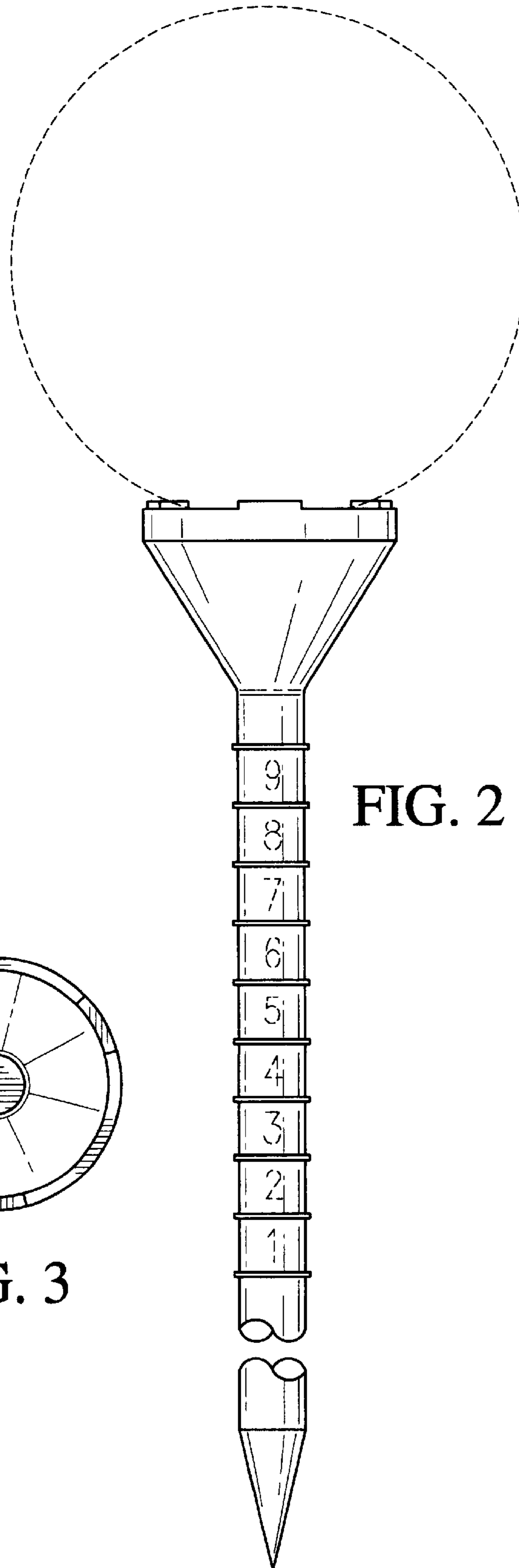

FIG. 2

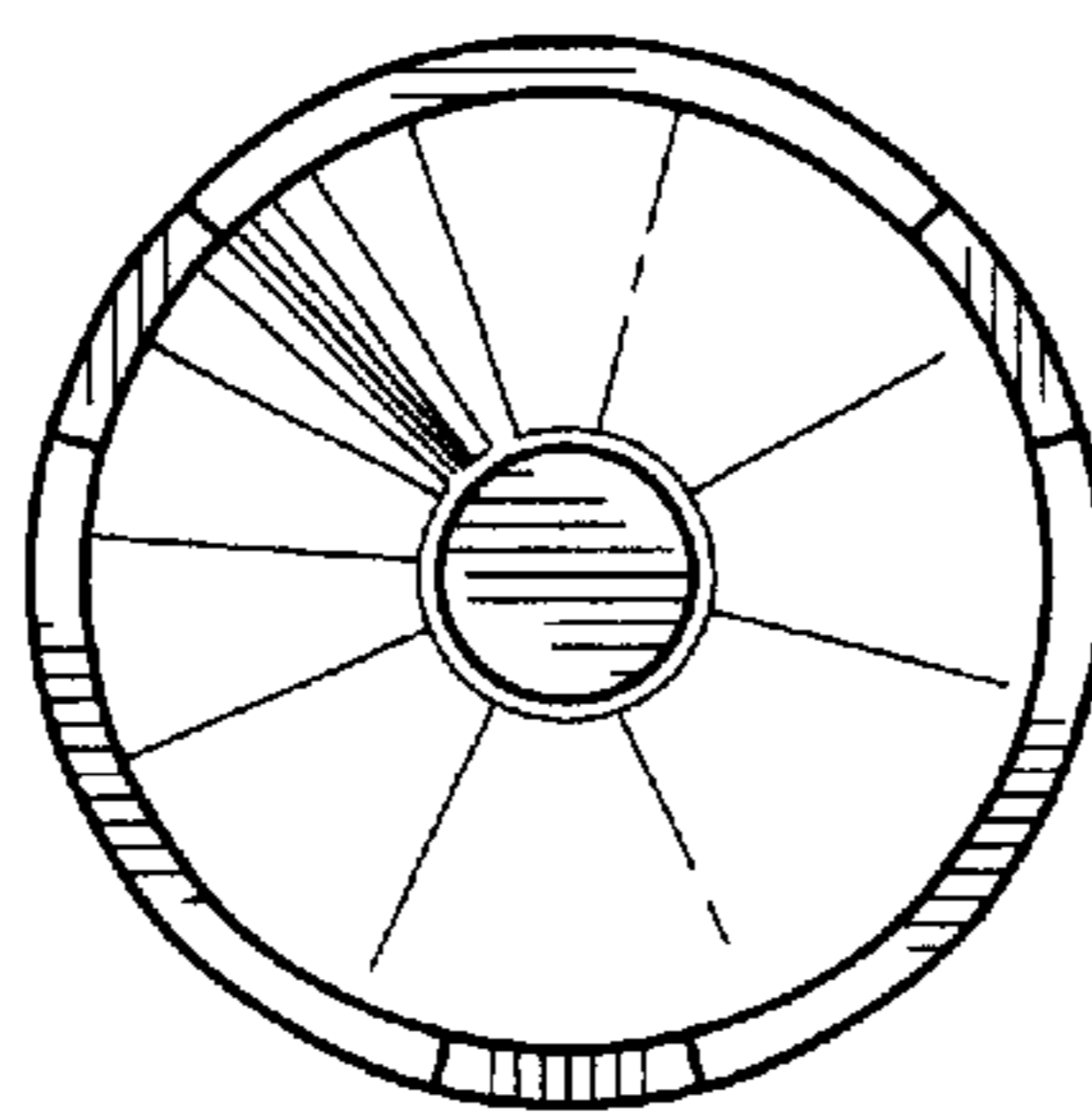

FIG. 3

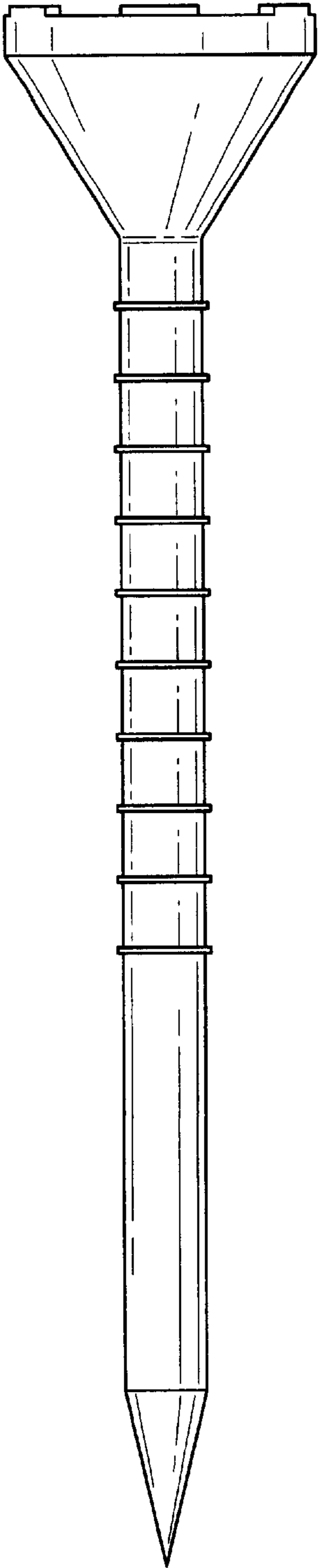

FIG. 4

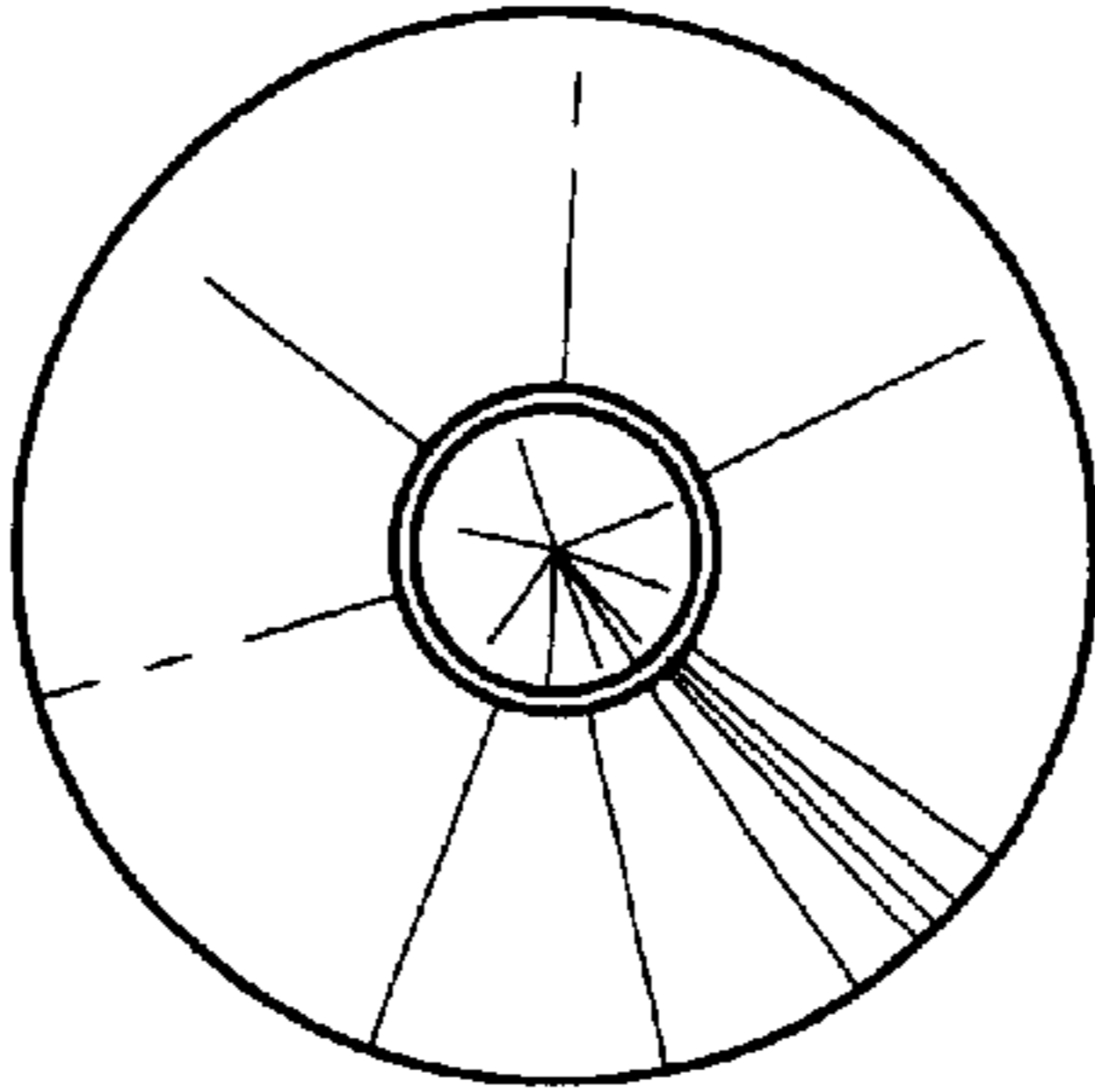

FIG. 5

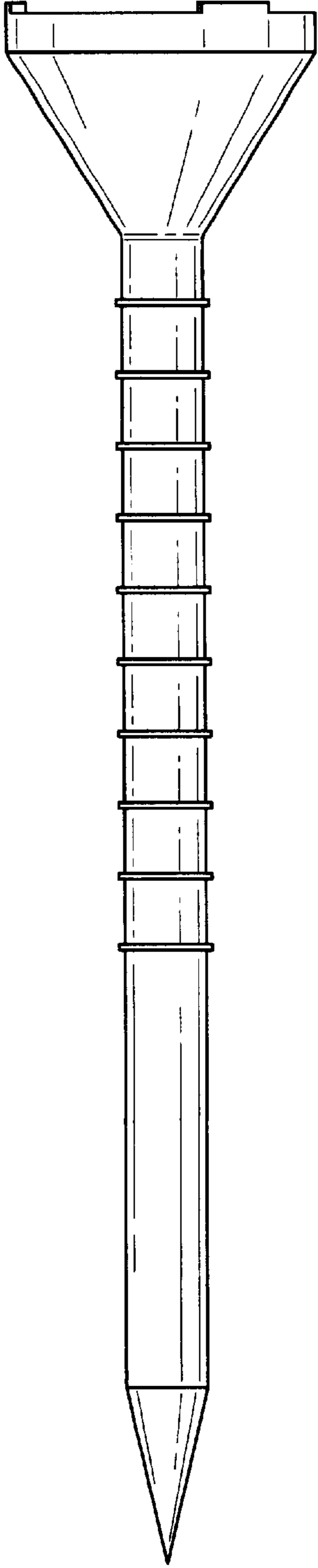

FIG. 6

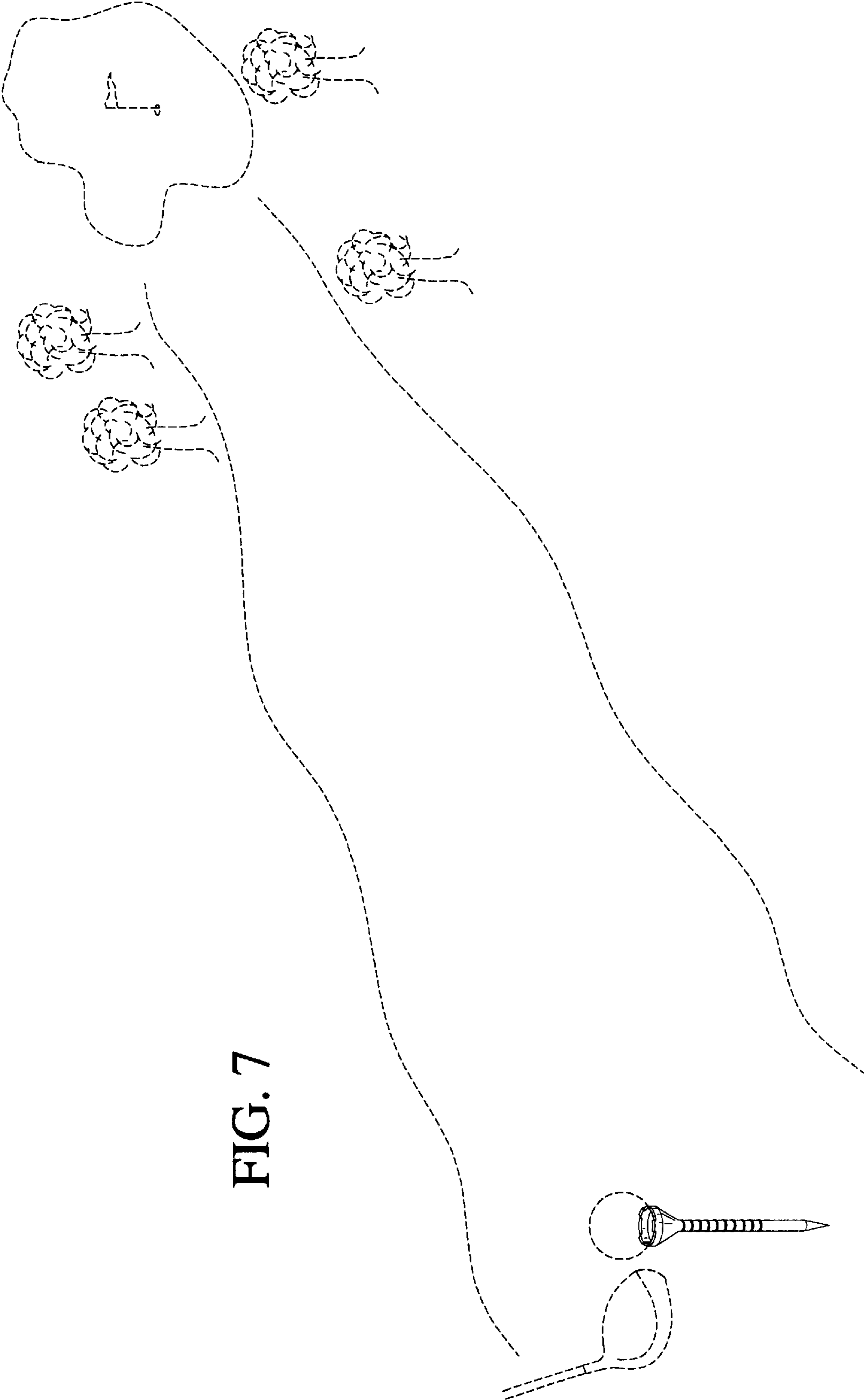

FIG. 7