



US00D517606S

(12) **United States Design Patent**  
**Daffertshofer et al.**

(10) **Patent No.: US D517,606 S**  
(45) **Date of Patent: \*\* Mar. 21, 2006**

(54) **TAPE DISPENSER**

D323,531 S \* 1/1992 Fortune ..... D19/69  
D379,474 S \* 5/1997 Packard ..... D19/69

(75) Inventors: **Gerd Daffertshofer**, Neuss (DE);  
**Matthias Rhode**, Kaarst (DE)

\* cited by examiner

(73) Assignee: **Henkel Kommanditgesellschaft auf Aktien**, Duesseldorf (DE)

*Primary Examiner*—Jeffrey Asch  
*Assistant Examiner*—Elizabeth Albert  
(74) *Attorney, Agent, or Firm*—Stephen D. Harper; Glenn E. J. Murphy

(\*\*) Term: **14 Years**

(57) **CLAIM**

(21) Appl. No.: **29/215,861**

The ornamental design for a tape dispenser, as shown and described.

(22) Filed: **Oct. 25, 2004**

(30) **Foreign Application Priority Data**

**DESCRIPTION**

Apr. 23, 2004 (DE) ..... 4 04 02 571

(51) **LOC (8) Cl.** ..... **19-02**

(52) **U.S. Cl.** ..... **D19/69**

(58) **Field of Classification Search** ..... D19/66,  
D19/67, 68, 69, 70; 156/523, 527, 540, 577;  
206/411; 225/6, 25, 39, 77; 242/588, 588.1,  
242/588.2, 588.3, 588.6, 598.5

See application file for complete search history.

FIG. 1 is a top right front perspective view of the first embodiment of a tape dispenser showing our new design; FIG. 2 is a front elevation view thereof; FIG. 3 is a rear elevation view thereof; FIG. 4 is a right elevation view thereof; FIG. 5 is a left elevation view thereof; FIG. 6 is a top plan view thereof; and FIG. 7 is a bottom plan view thereof. FIG. 8 is a top right front perspective view of the second embodiment of a tape dispenser; FIG. 9 is a front elevation view thereof; FIG. 10 is a rear elevation view thereof; FIG. 11 is a right elevation view thereof; FIG. 12 is a left elevation view thereof; FIG. 13 is a top plan view thereof; and, FIG. 14 is a bottom plan view thereof.

(56) **References Cited**

**U.S. PATENT DOCUMENTS**

- D186,343 S \* 10/1959 Gershen ..... D19/69
- D203,622 S \* 2/1966 Quenot ..... D10/72
- D226,989 S \* 5/1973 Kikuchi et al. .... D19/69
- 3,968,915 A \* 7/1976 Schleicher ..... 225/65
- 4,222,509 A \* 9/1980 Smith ..... 225/77
- D314,156 S \* 1/1991 Doyle ..... D10/61

**1 Claim, 8 Drawing Sheets**

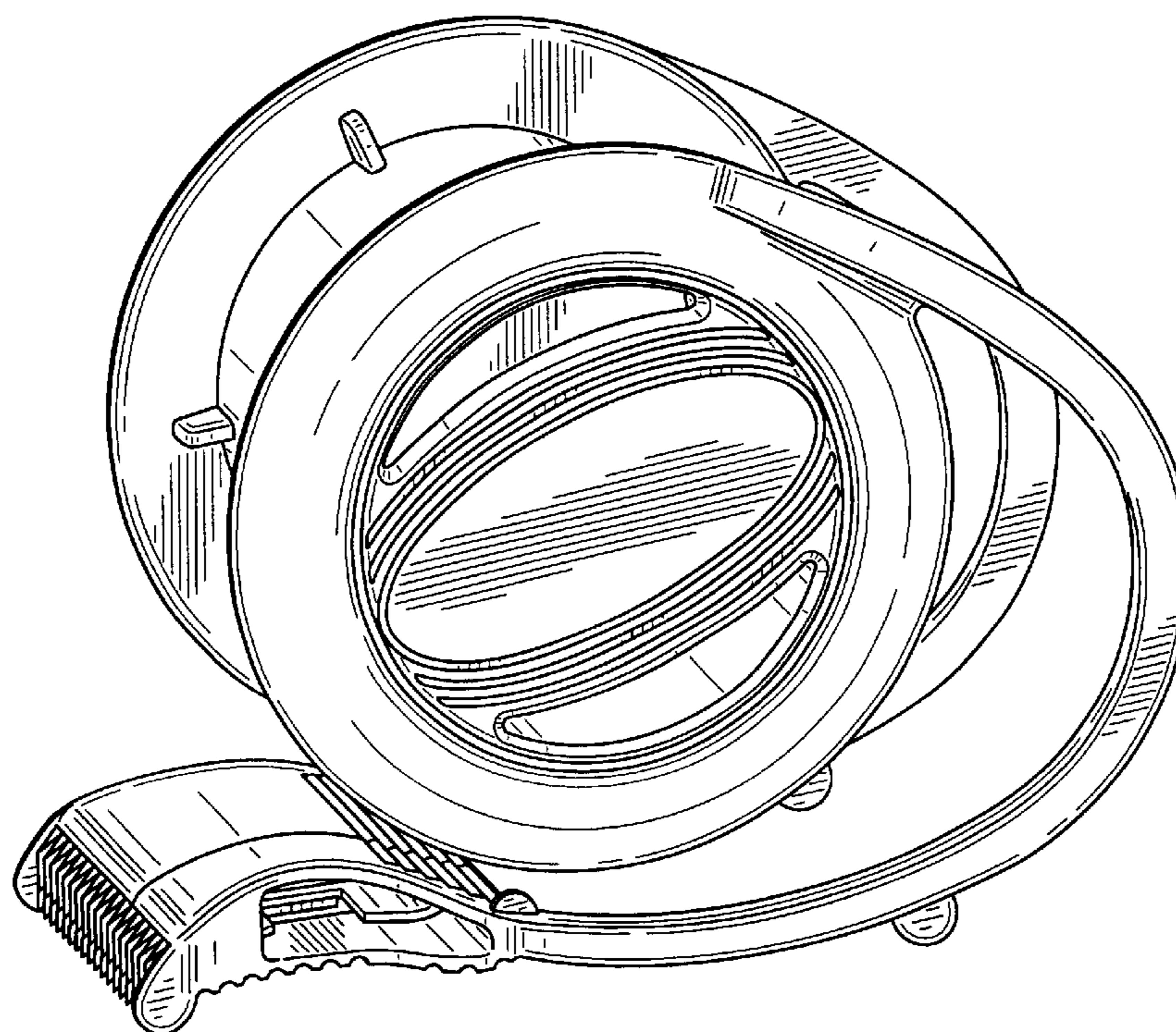

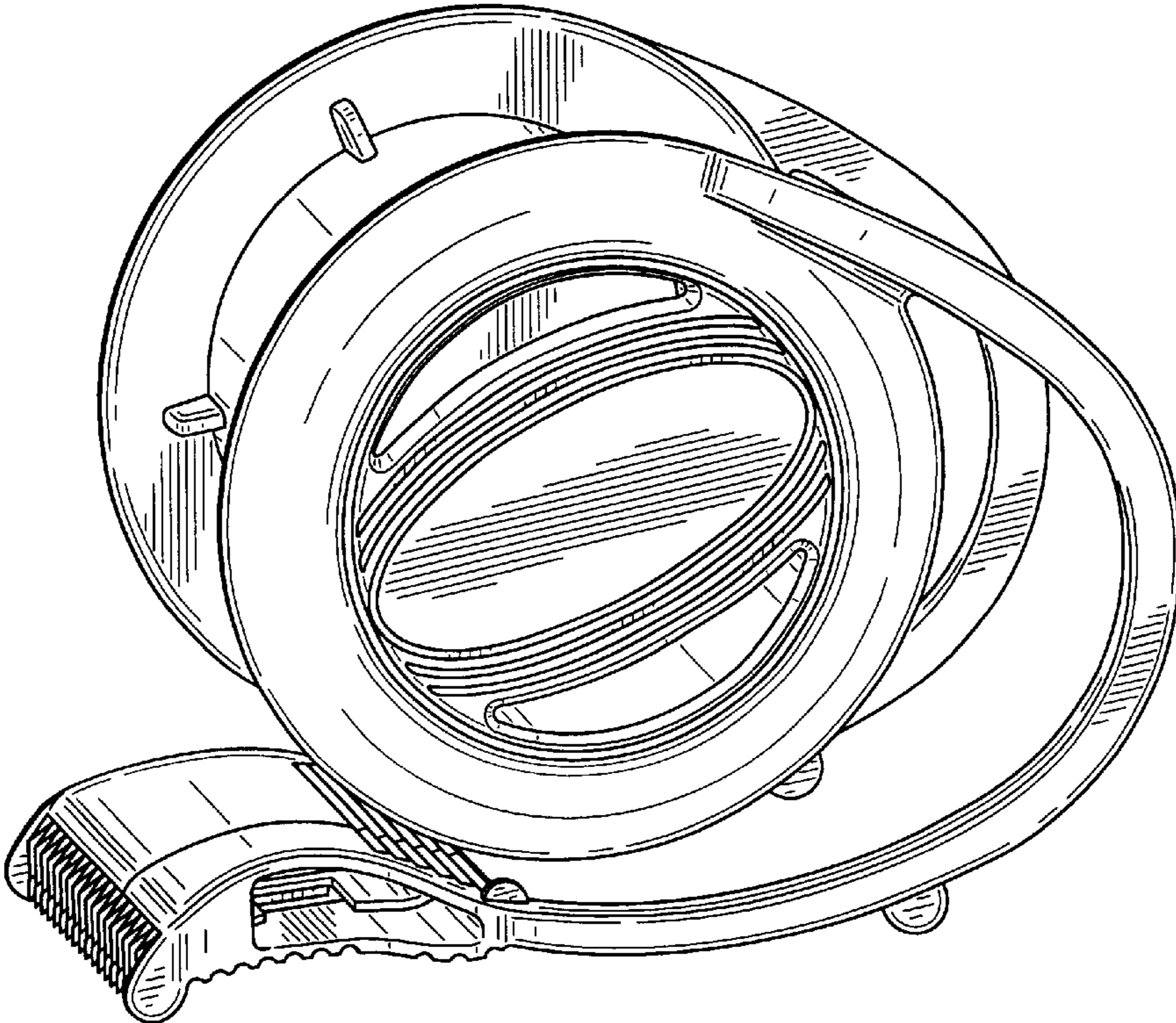

FIG. 1

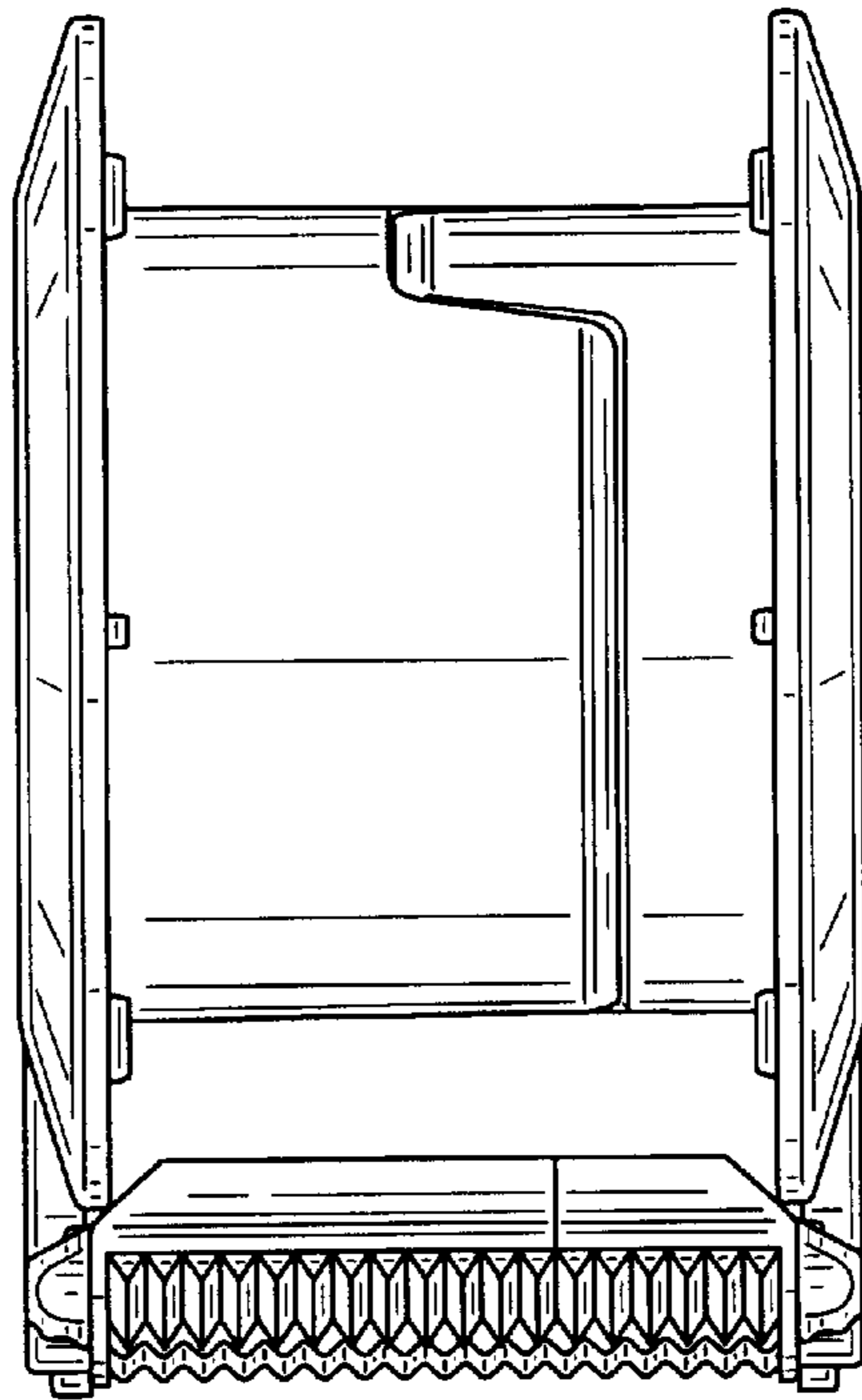

FIG. 2

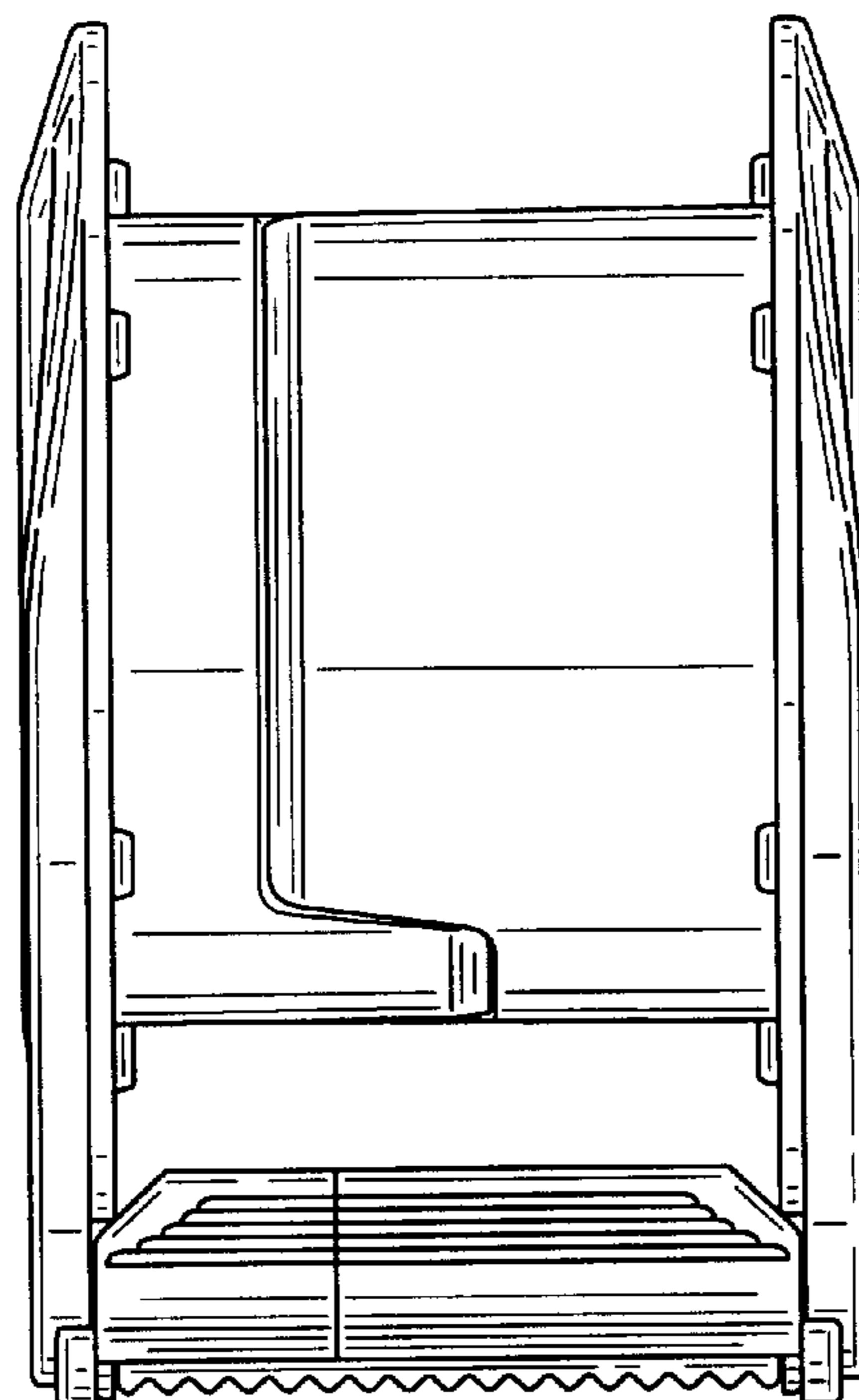

FIG. 3

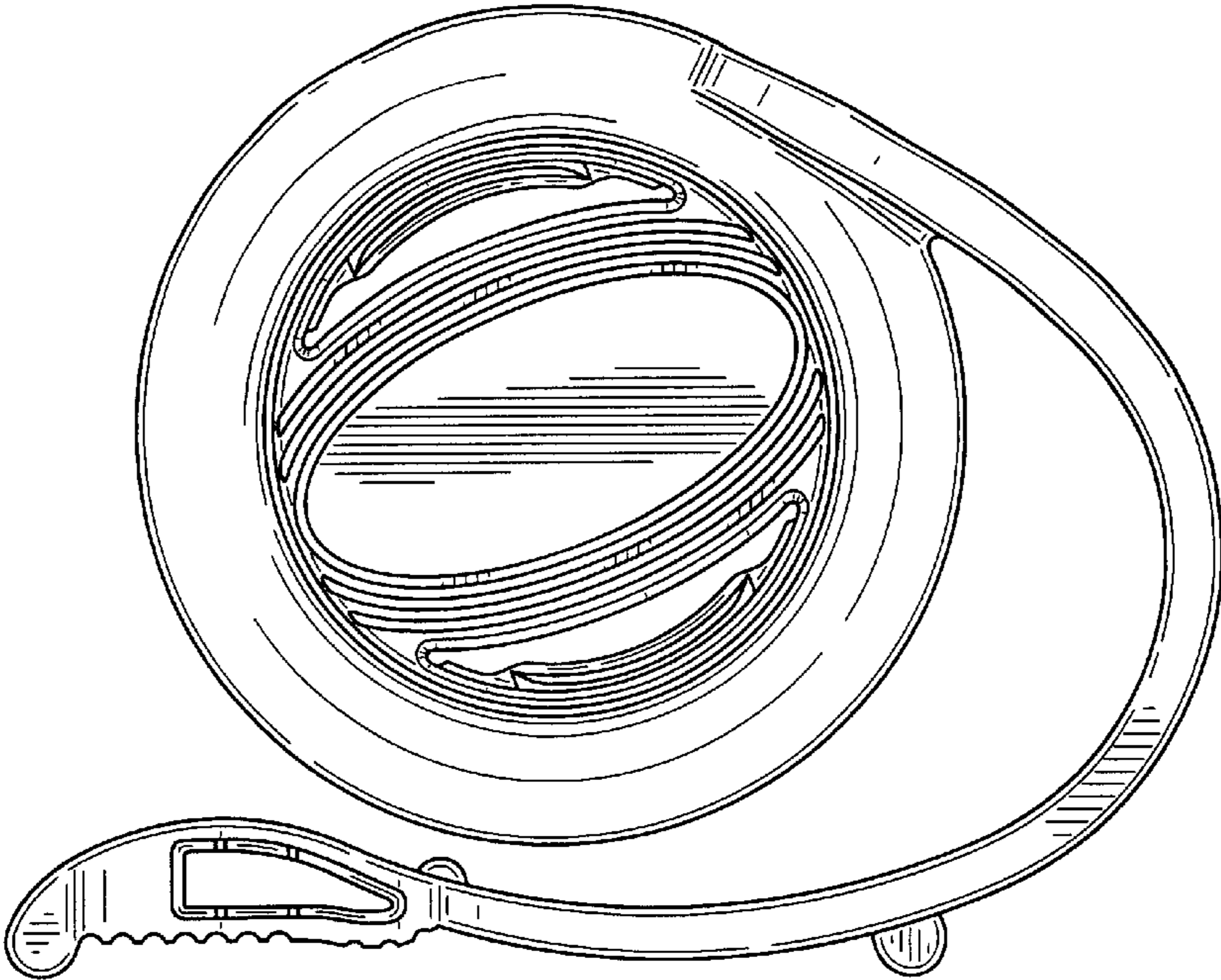

FIG. 4

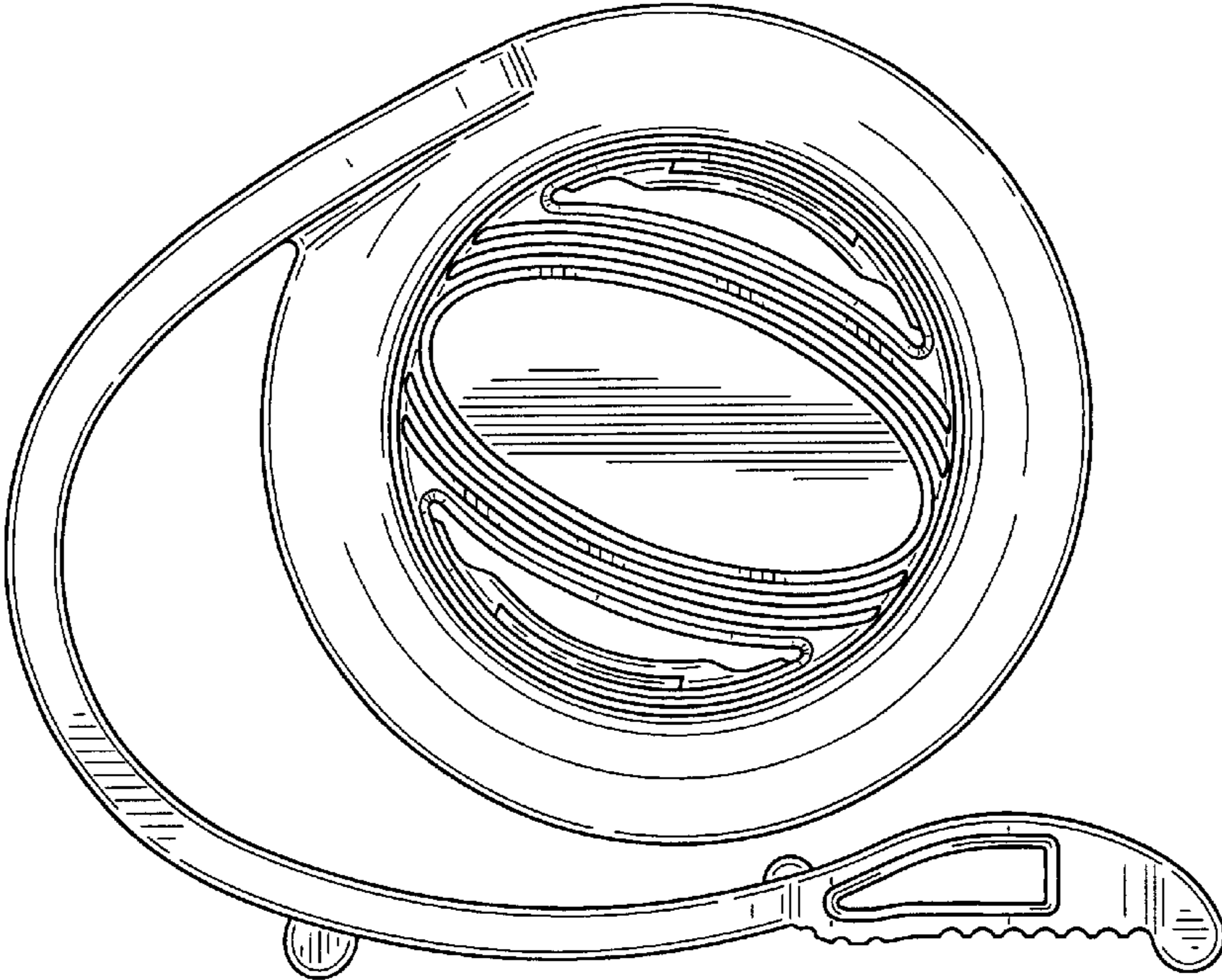

FIG. 5

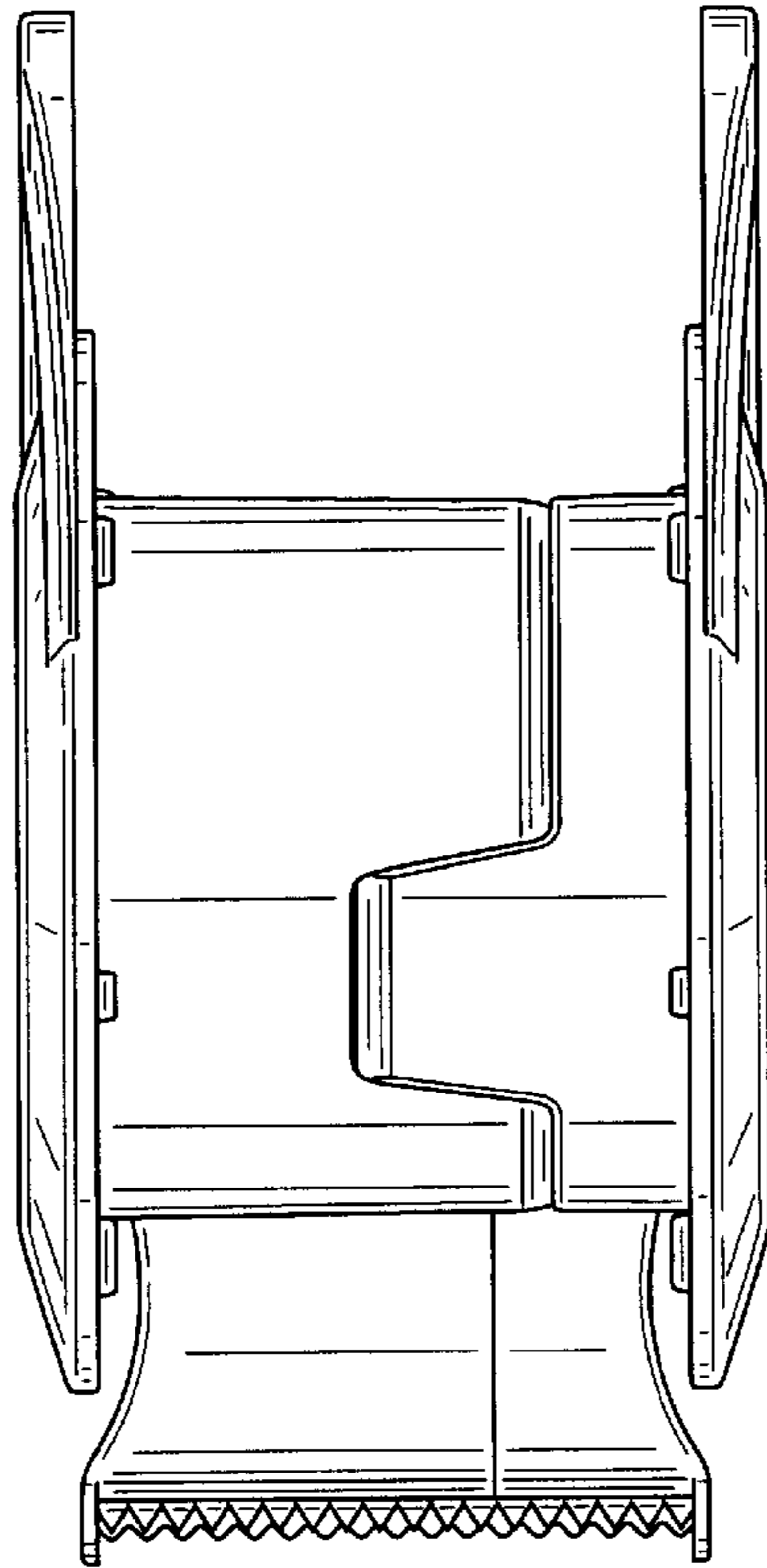

FIG. 6

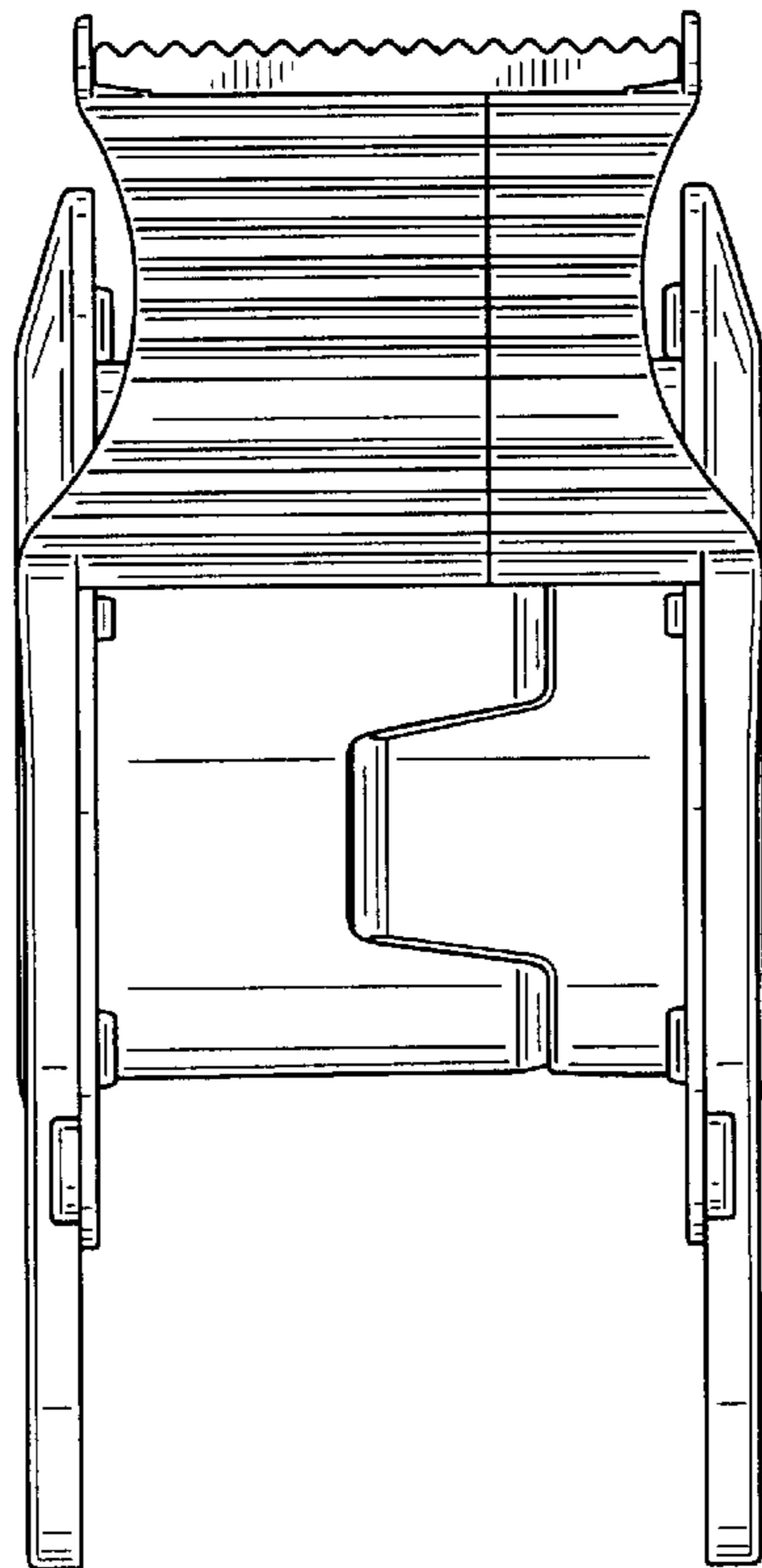

FIG. 7

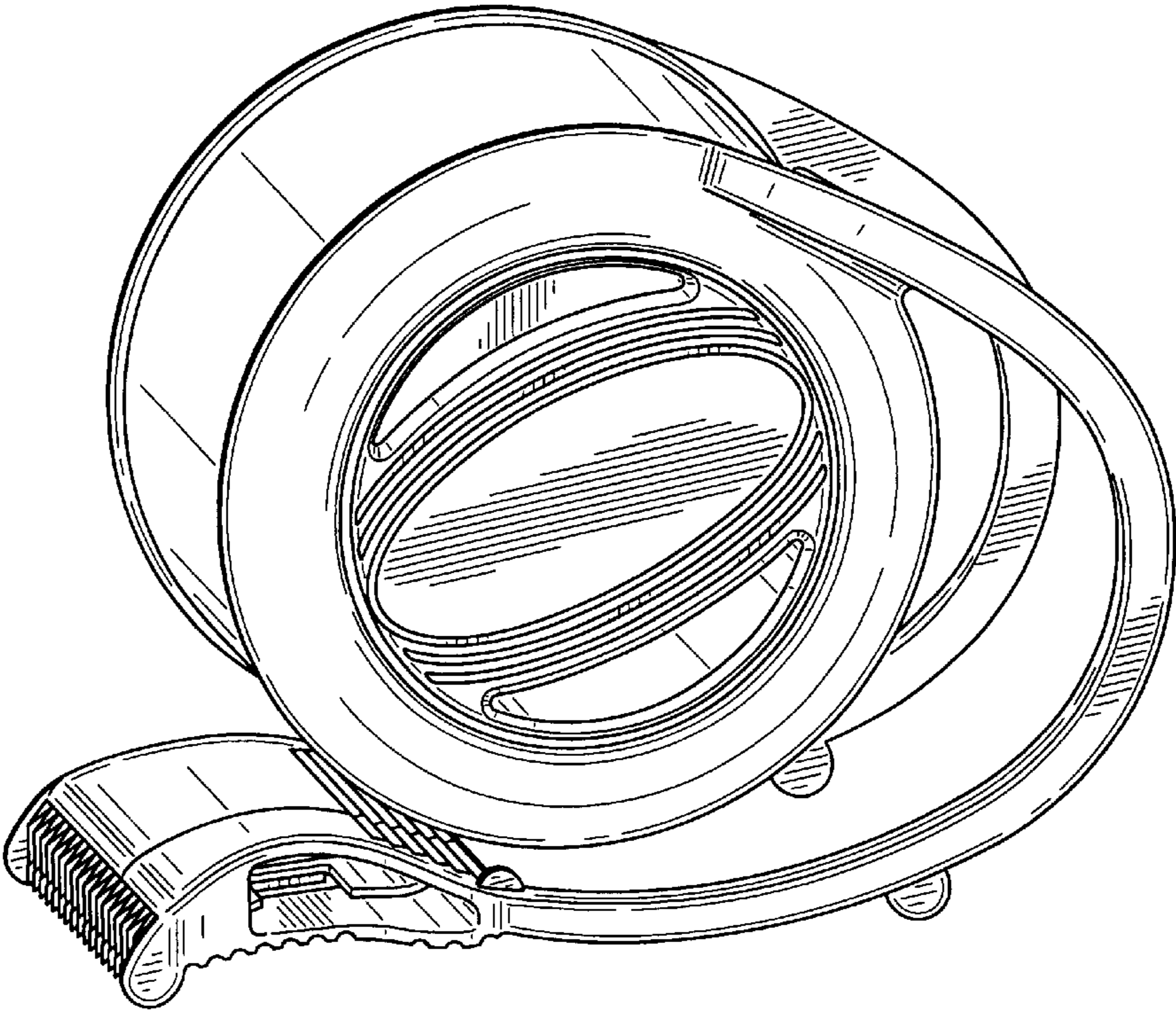

FIG. 8

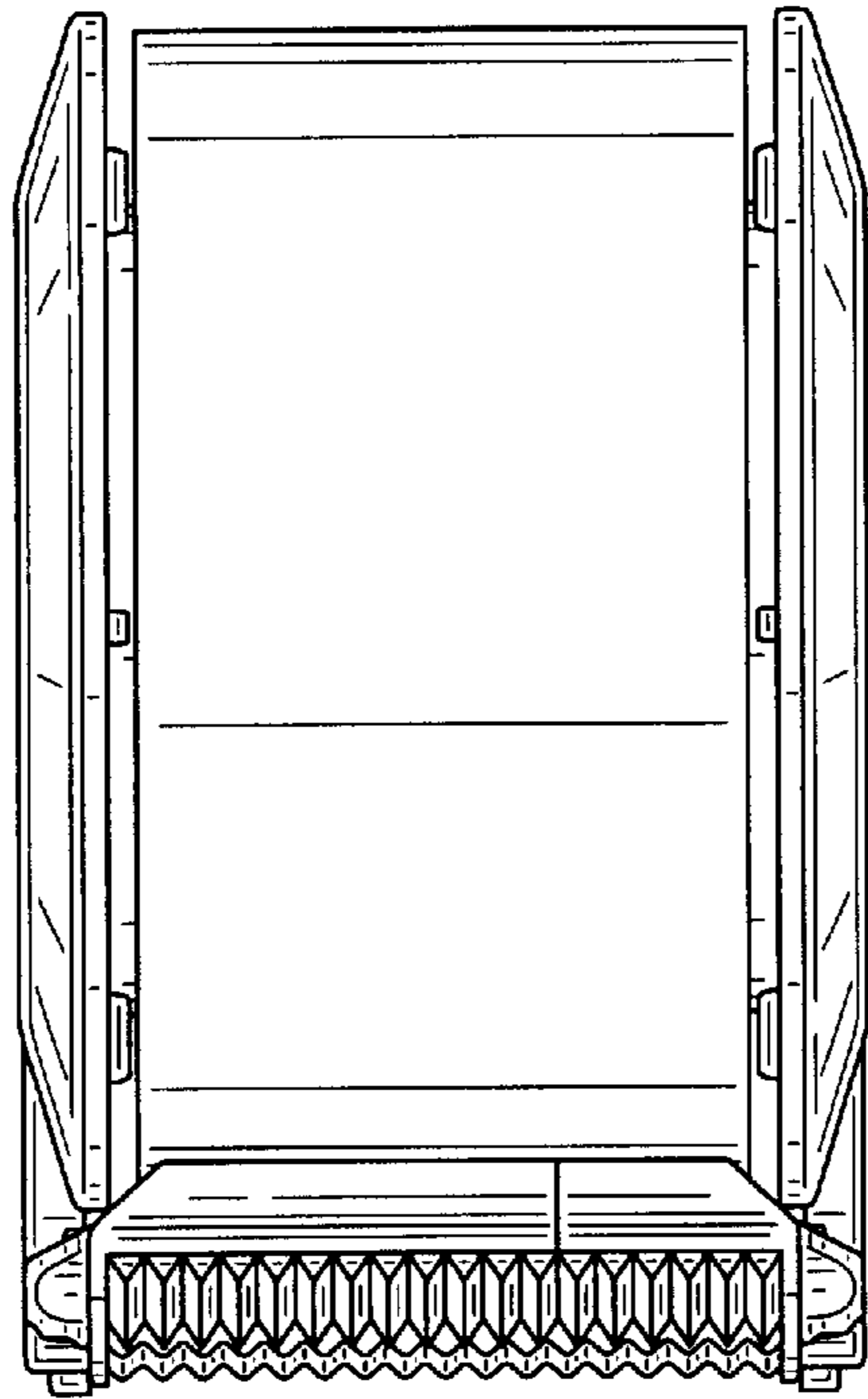

FIG. 9

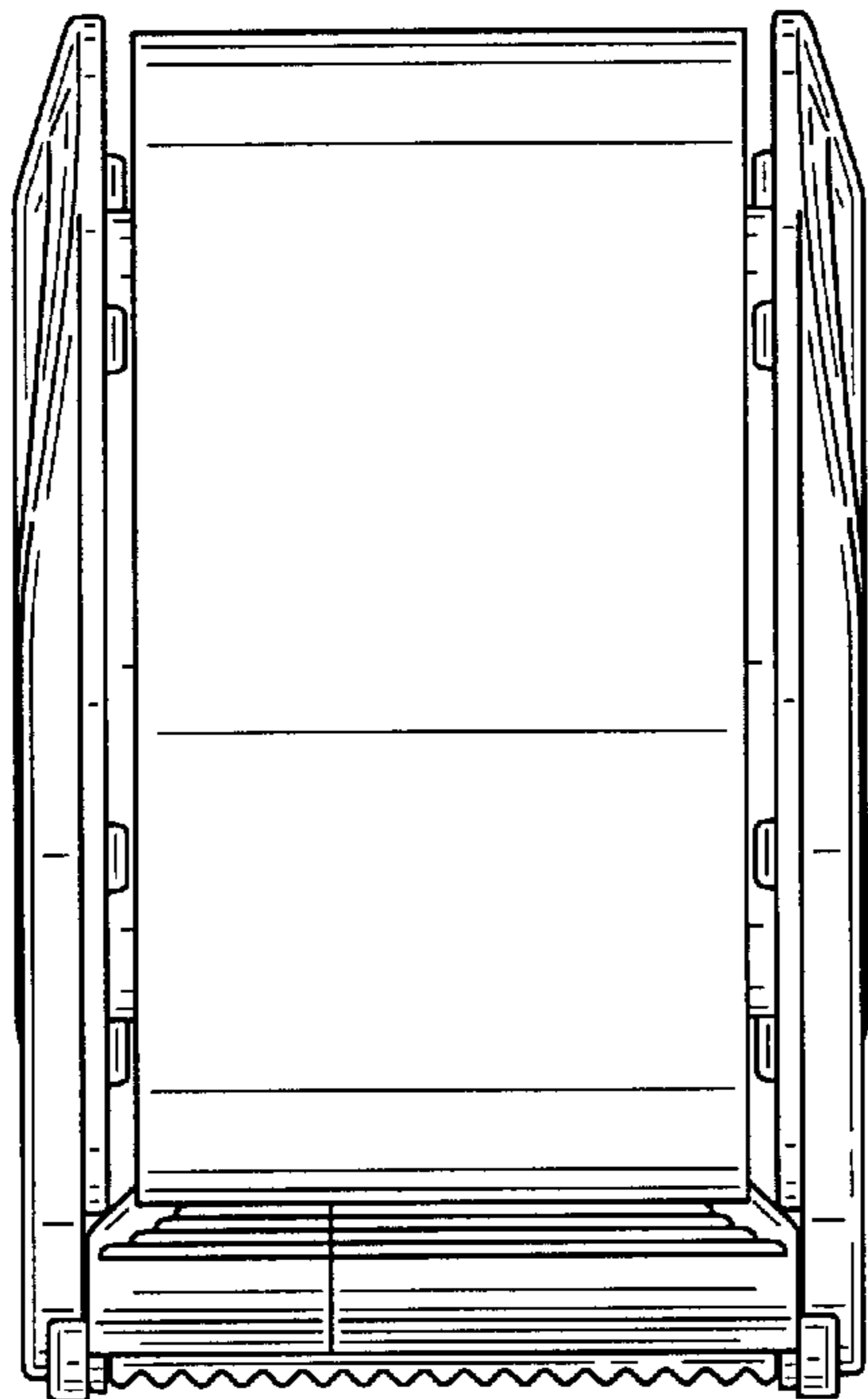

FIG. 10

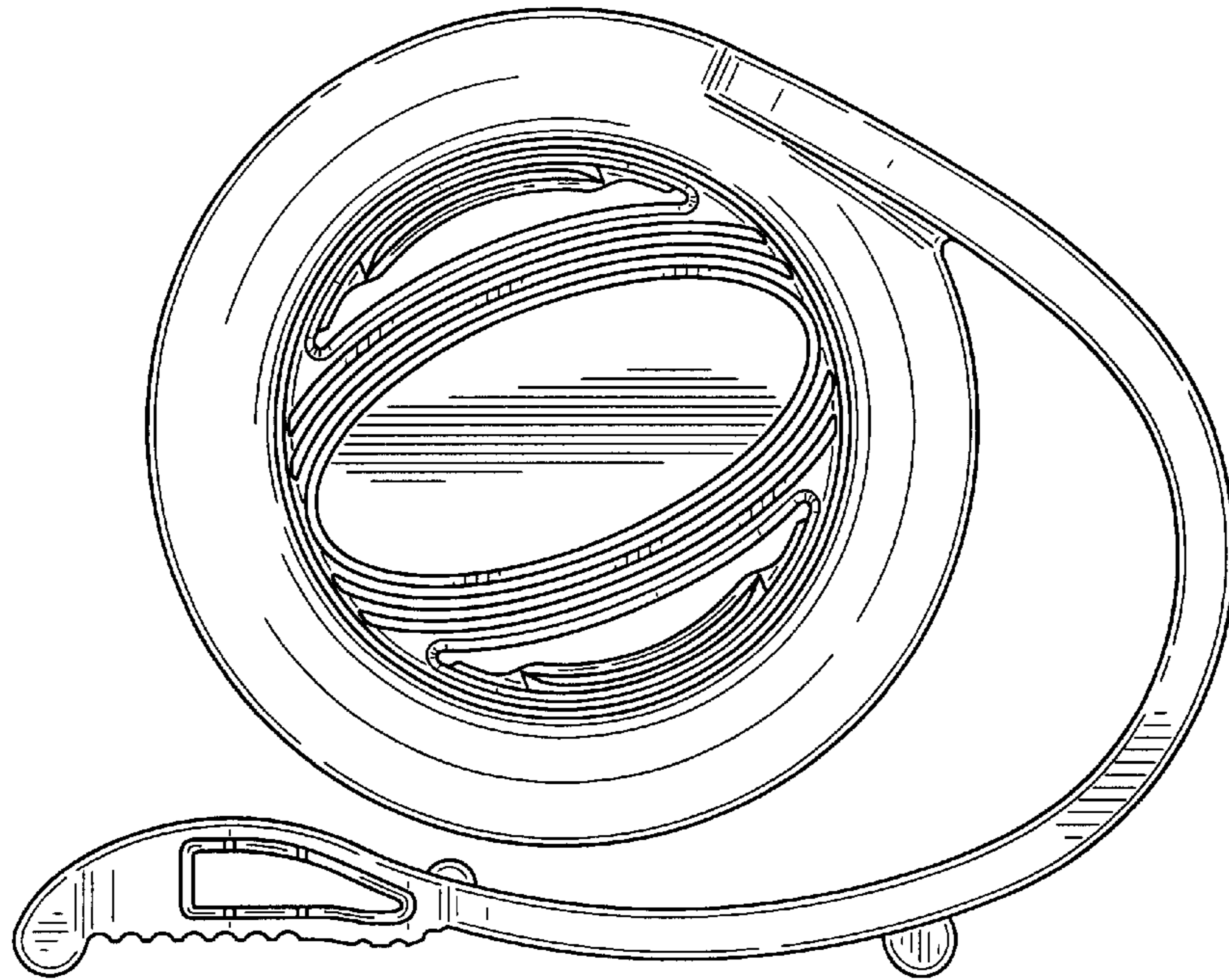

FIG. 11

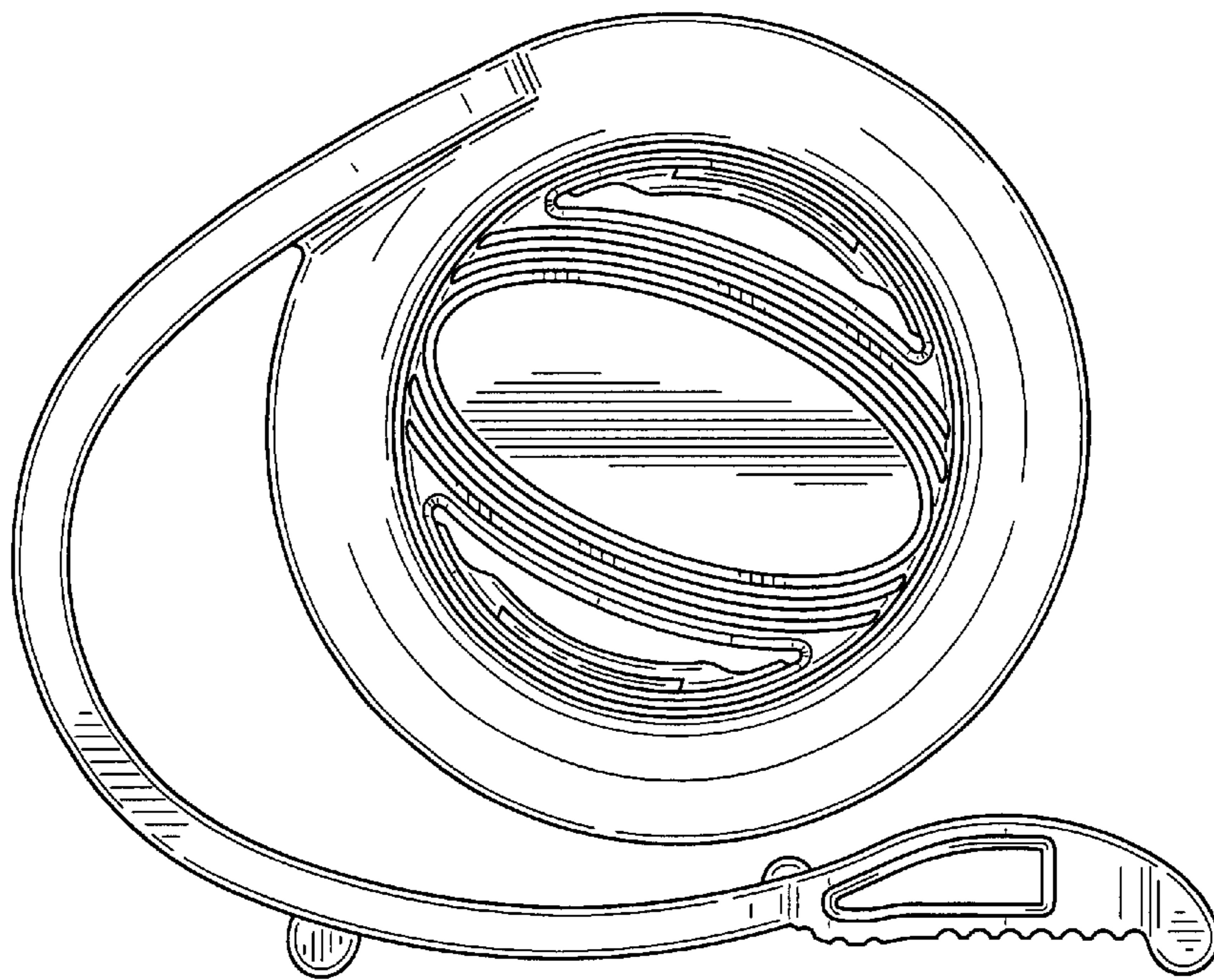

FIG. 12



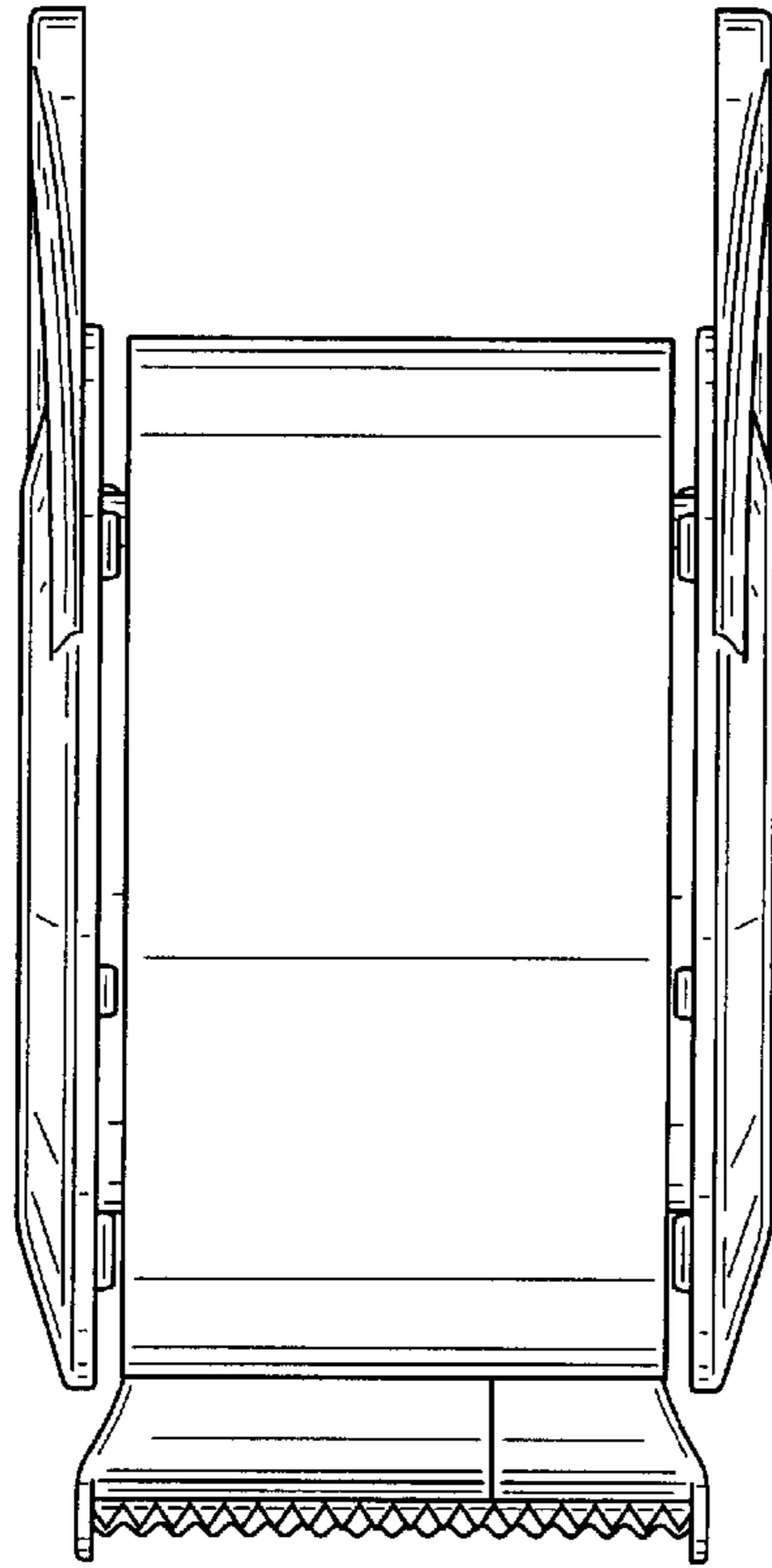

FIG. 13

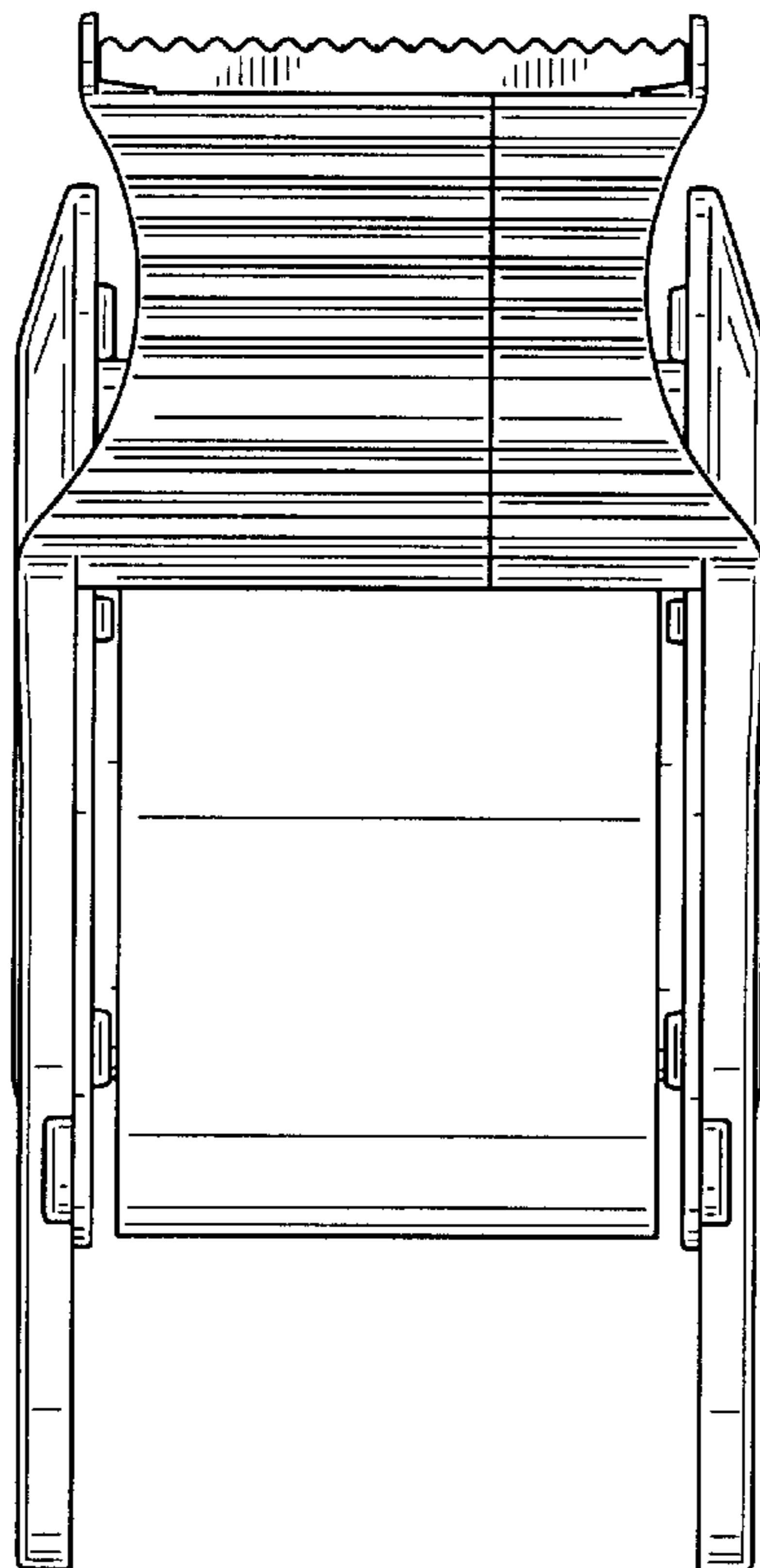

FIG. 14