

US00D517591S

(12) **United States Design Patent**  
**Kokido**

(10) **Patent No.:** **US D517,591 S**  
(45) **Date of Patent:** **\*\* Mar. 21, 2006**

(54) **WHITE KEY OF AN ELECTRONIC  
KEYBOARD MUSICAL INSTRUMENT**

(75) Inventor: **Shinichiro Kokido**, Kunitachi (JP)

(73) Assignee: **Casio Keisanki Kabushiki Kaisha**,  
Tokyo (JP)

(\*\*) Term: **14 Years**

(21) Appl. No.: **29/210,244**

(22) Filed: **Jul. 28, 2004**

(51) **LOC (8) Cl.** ..... **17-01**

(52) **U.S. Cl.** ..... **D17/9**

(58) **Field of Classification Search** ..... D14/395;  
D17/1, 5, 6, 9; 84/423 R, 428, 433-436,  
84/439

See application file for complete search history.

(56) **References Cited**

**U.S. PATENT DOCUMENTS**

3,570,359	A	*	3/1971	Ohno	.....	84/423	R
D232,865	S	*	9/1974	Jarvis	.....	D17/9	
D324,231	S	*	2/1992	Mutoh	.....	D17/9	
6,051,768	A	*	4/2000	Masubuchi	.....	84/433	
6,060,653	A	*	5/2000	Willis	.....	84/433	

\* cited by examiner

*Primary Examiner*—Adir Aronovich

(74) *Attorney, Agent, or Firm*—Frishauf, Holtz, Goodman  
& Chick, P.C.

(57) **CLAIM**

The ornamental design for a white key of an electronic keyboard musical instrument, as shown and described.

**DESCRIPTION**

FIG. 1 is a reduced scale front, left side, top perspective view of a white key of an electronic keyboard musical instrument showing my new design;

FIG. 2 is a front elevational view thereof;

FIG. 3 is a rear elevational view thereof;

FIG. 4 is a left side view thereof;

FIG. 5 is a right side view thereof;

FIG. 6 is a top plan view thereof;

FIG. 7 is a bottom plan view thereof;

FIG. 8 is an enlarged partial front elevational view thereof;

FIG. 9 is a sectional view of the upper portion taken along line 9—9 in FIG. 8;

FIG. 10 is a sectional view of the upper portion taken along line 10—10 in FIG. 8;

FIG. 11 is a sectional view of the upper portion taken along line 11—11 in FIG. 8;

FIG. 12 is a sectional view of the upper portion taken along line 12—12 in FIG. 8;

FIG. 13 is a sectional view of the upper portion taken along line 13—13 in FIG. 8;

FIG. 14 is a sectional view of the upper portion taken along line 14—14 in FIG. 8;

FIG. 15 is a sectional view of the rear part of the portion shown in FIG. 8, taken along line 15—15 in FIG. 8;

FIG. 16 is a sectional view of the rear part of the portion shown in FIG. 8, taken along line 16—16 in FIG. 8; and,

FIG. 17 is a sectional view of the rear part of the portion shown in FIG. 8, taken along line 17—17 in FIG. 8.

**1 Claim, 12 Drawing Sheets**

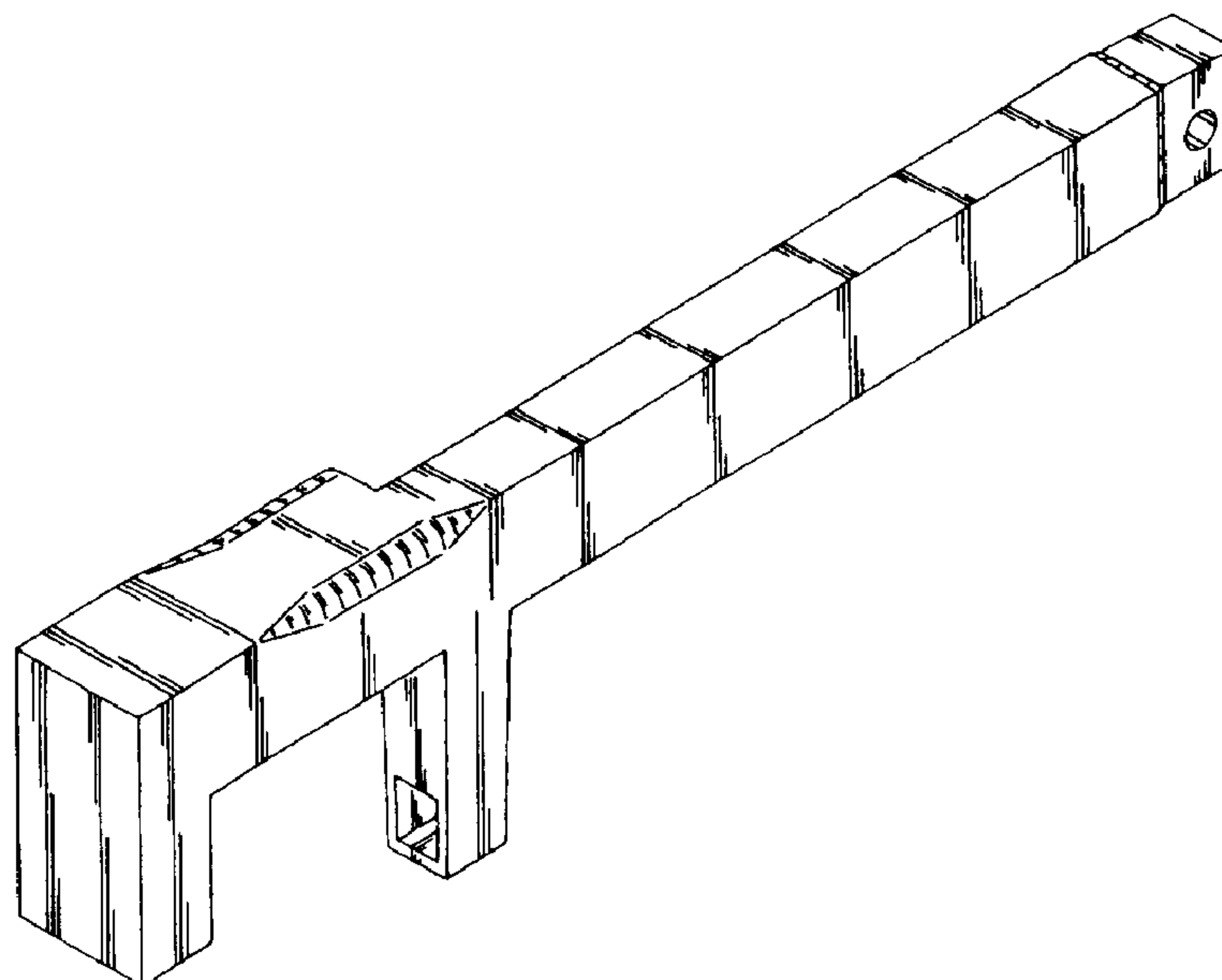

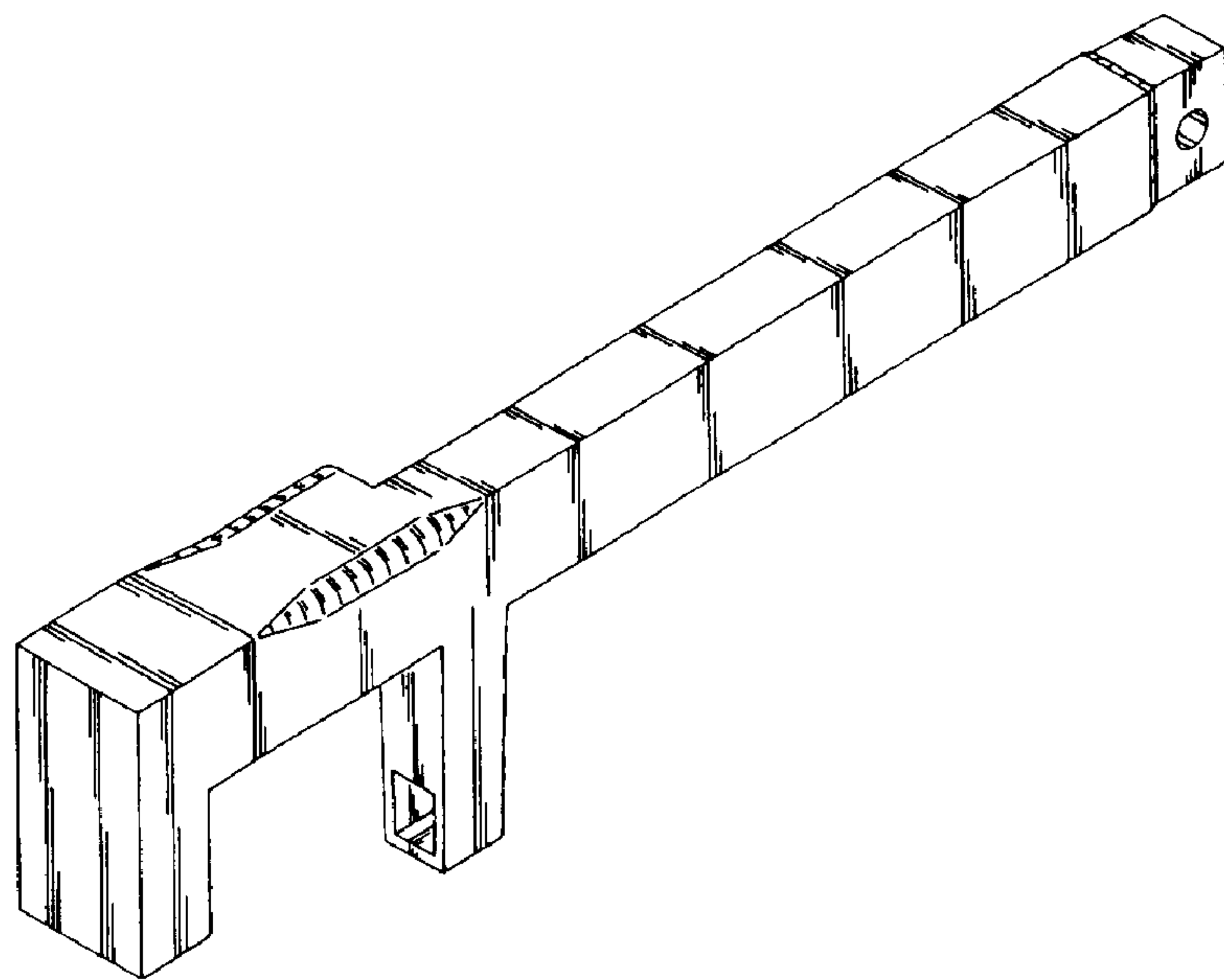

FIG. 1

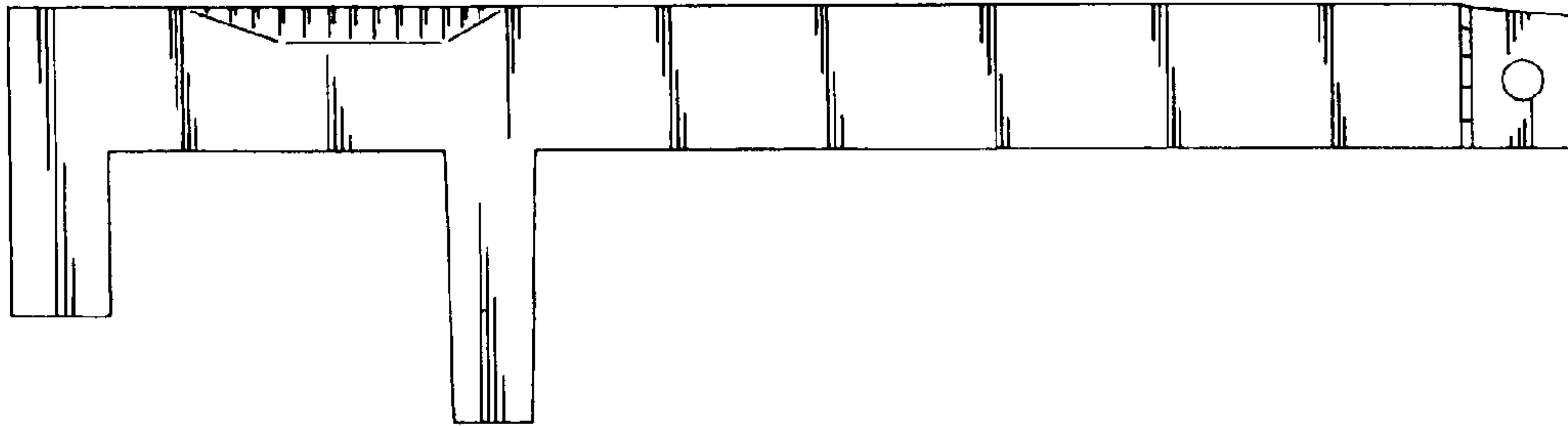

FIG. 2

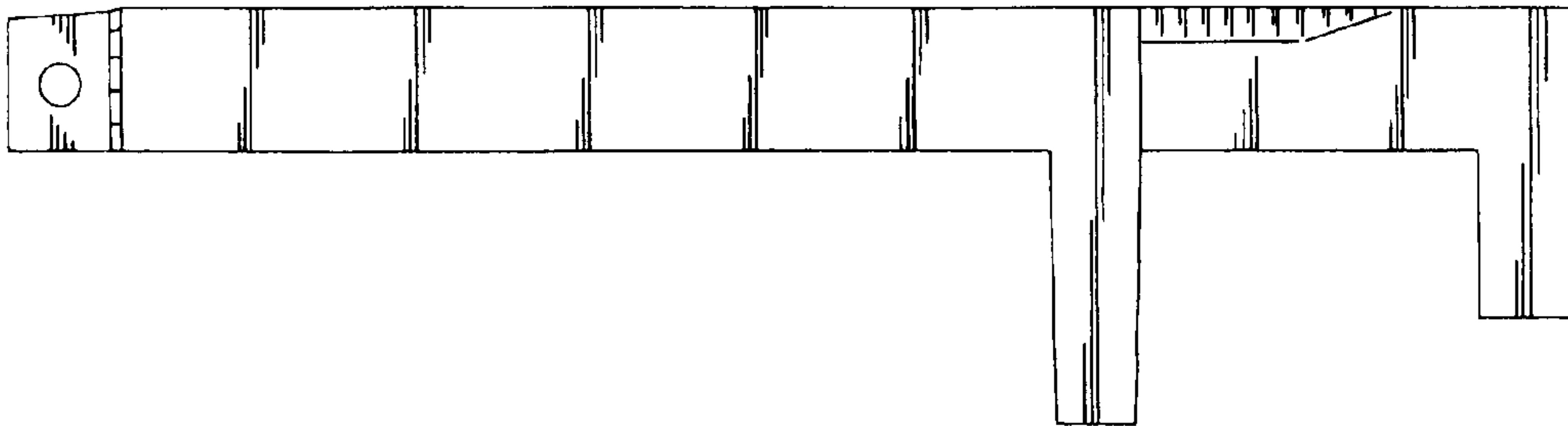

FIG. 3

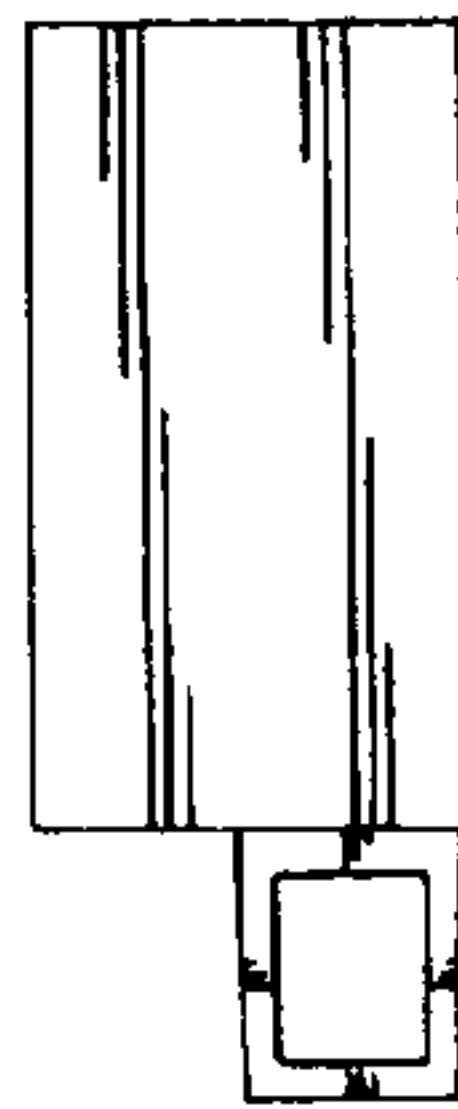

FIG. 4

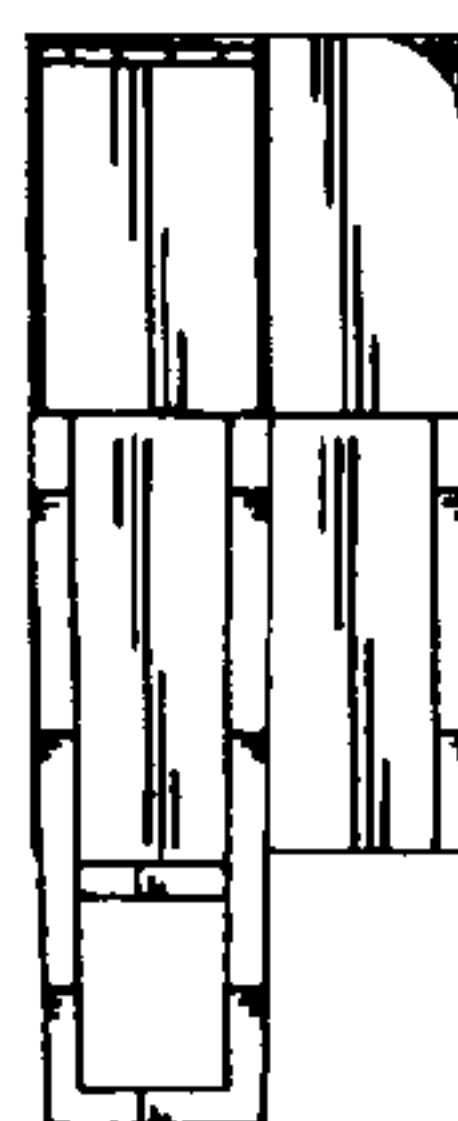

FIG. 5

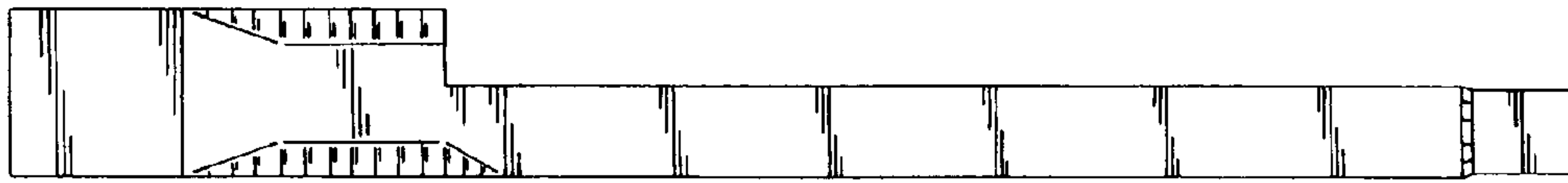

FIG. 6

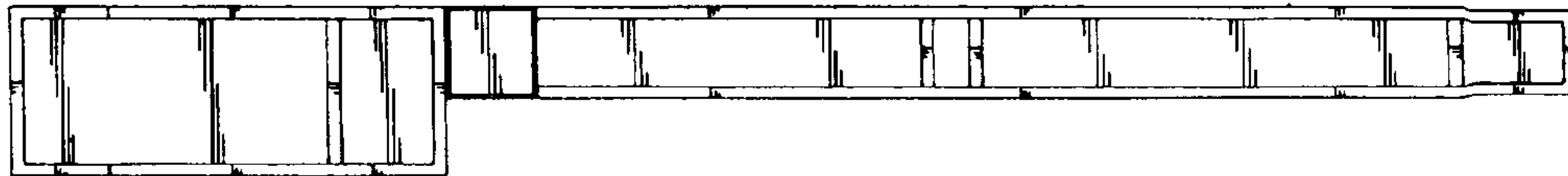

FIG. 7

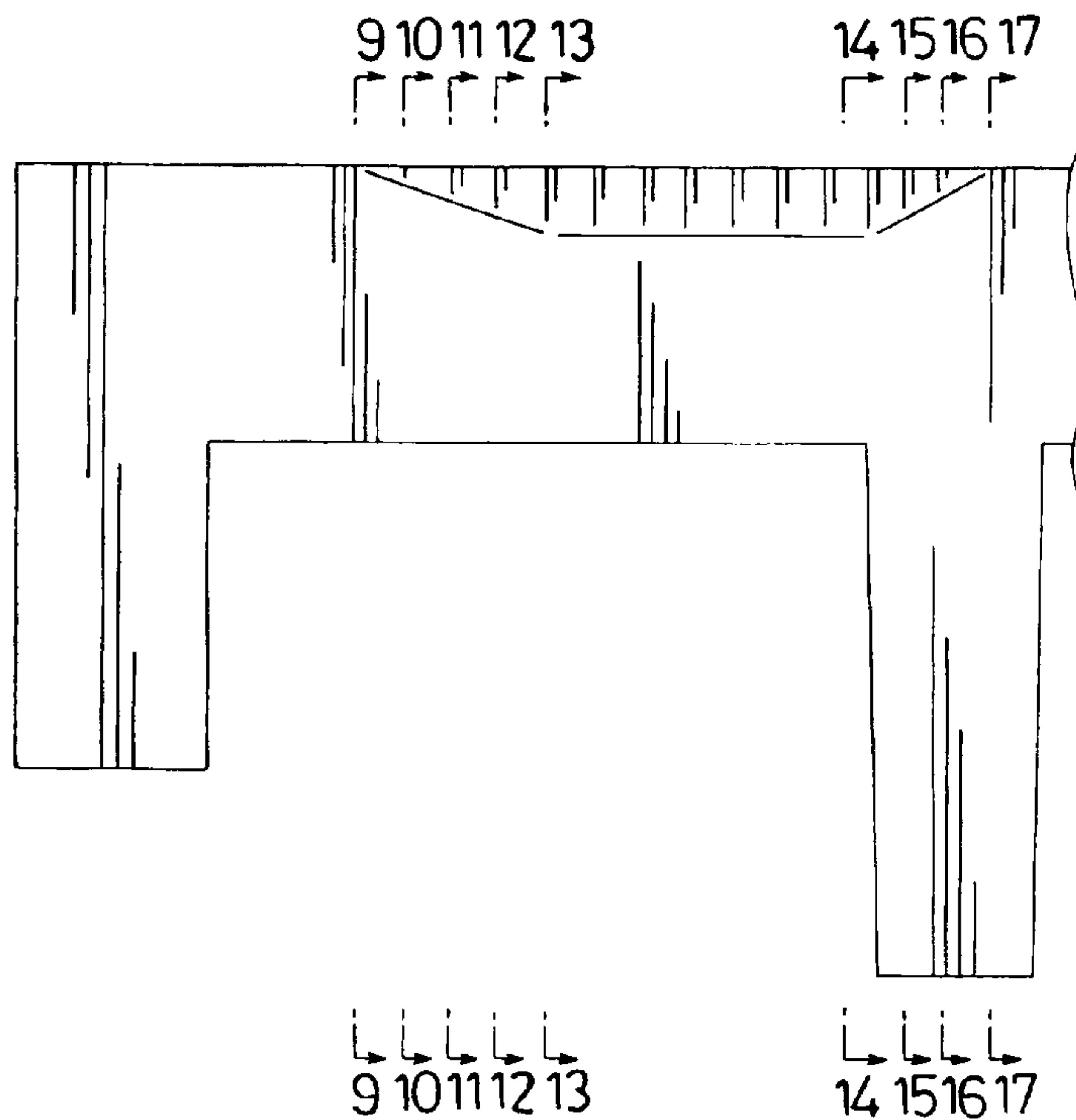
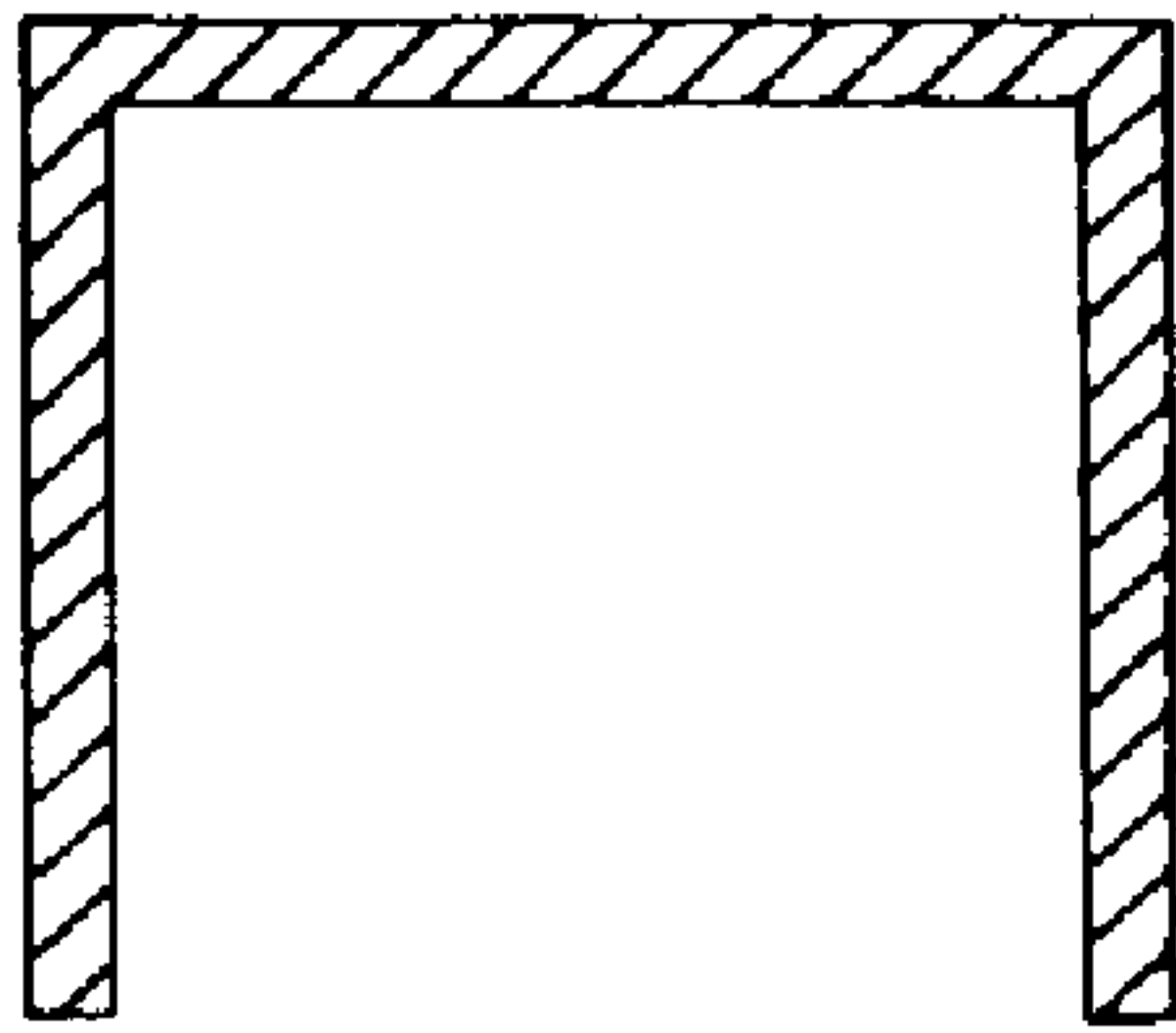
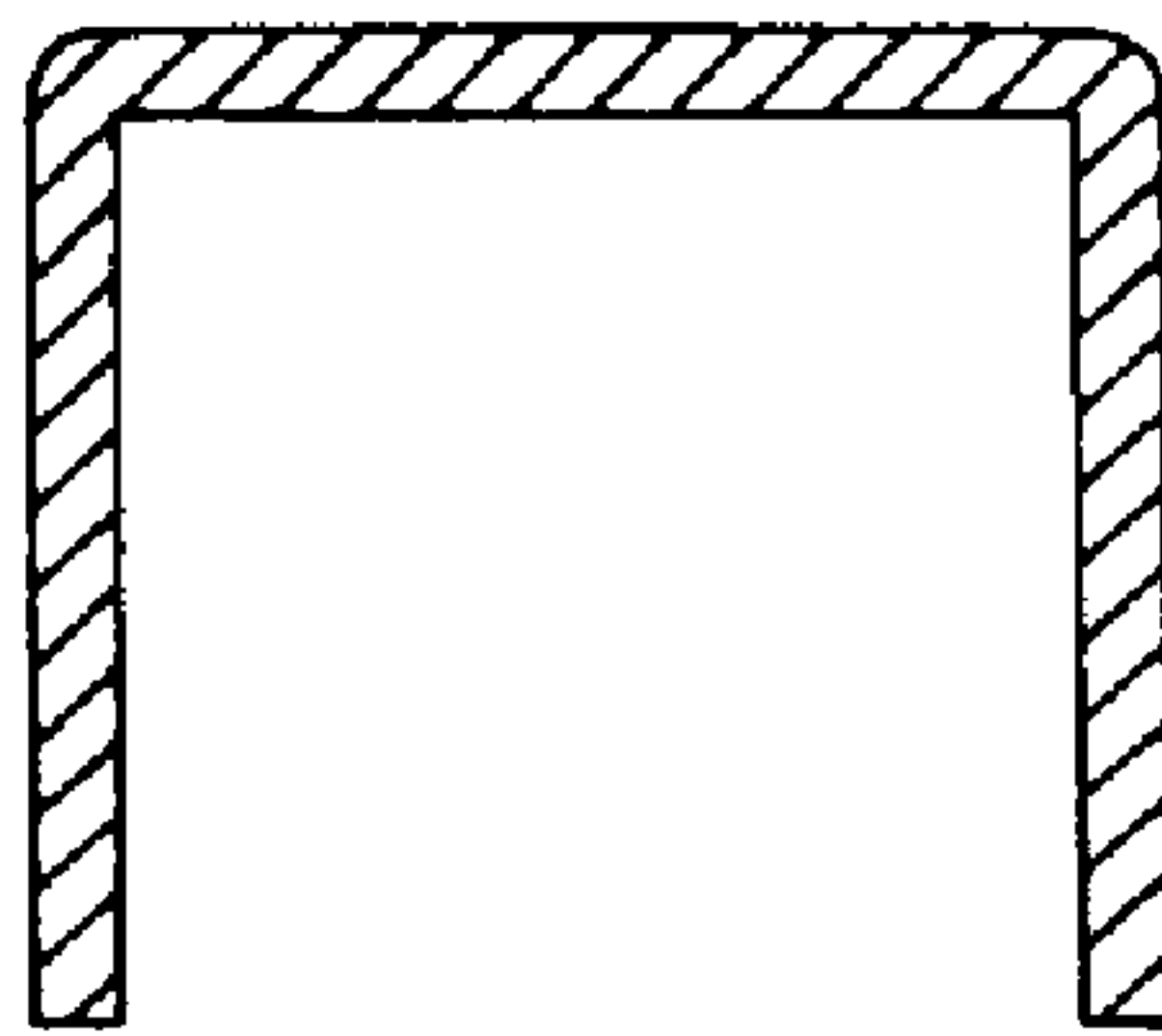

FIG. 8



**FIG. 9**



**FIG. 10**

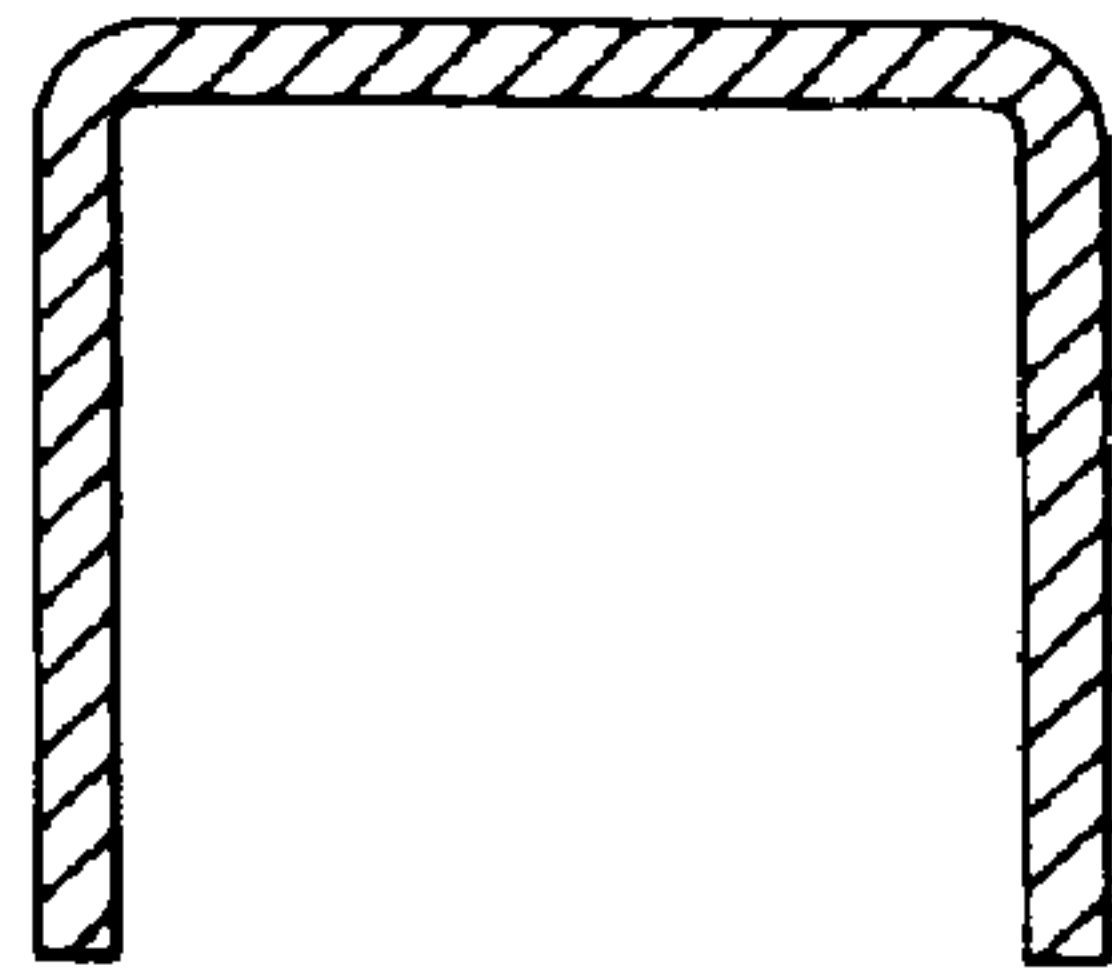

FIG. 11

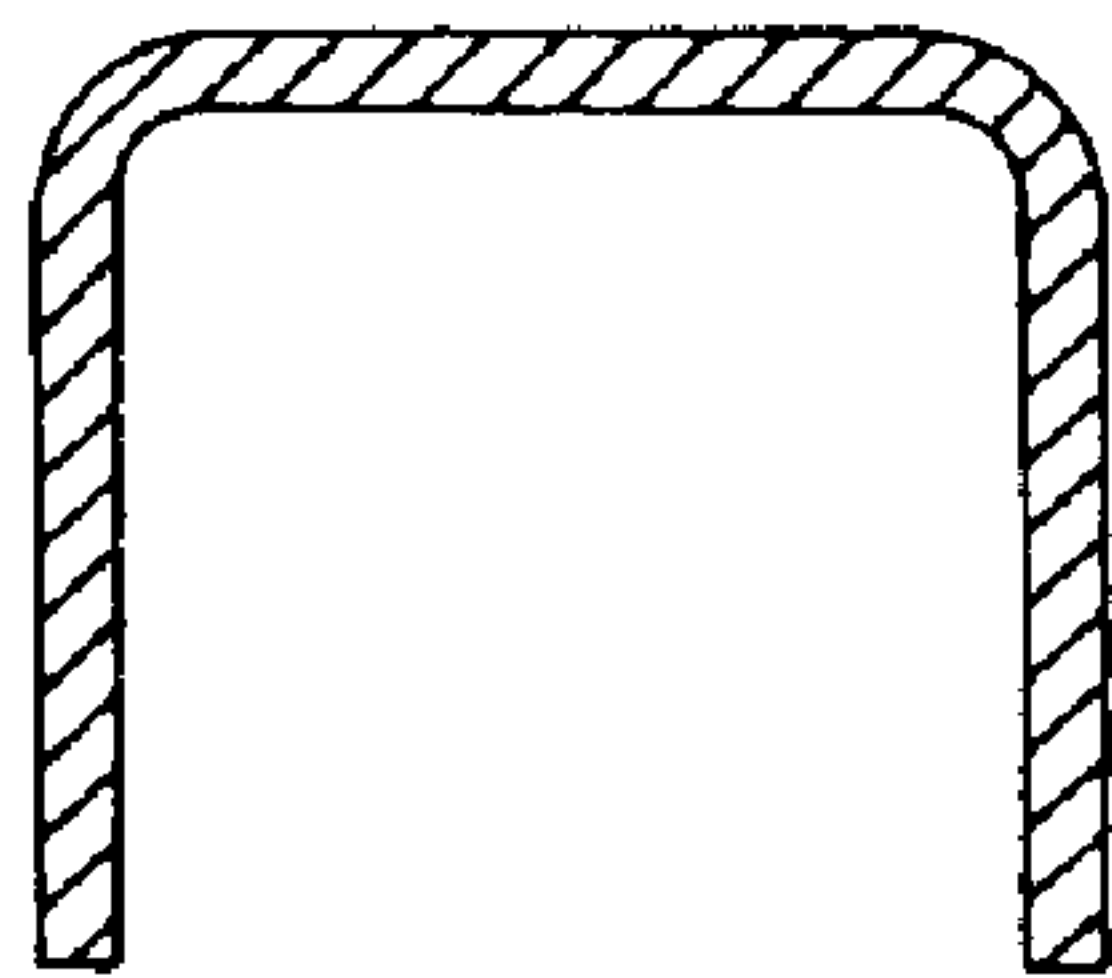

FIG. 12



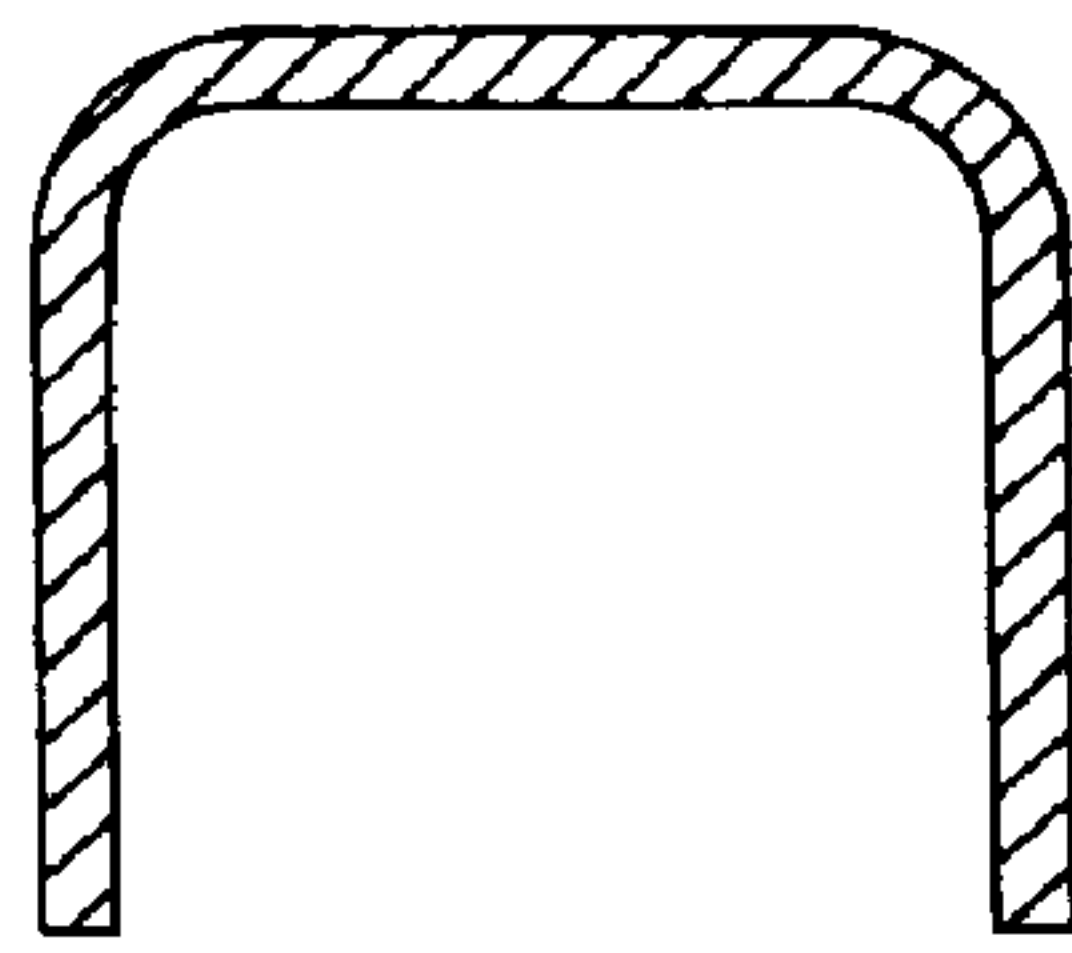

FIG. 13

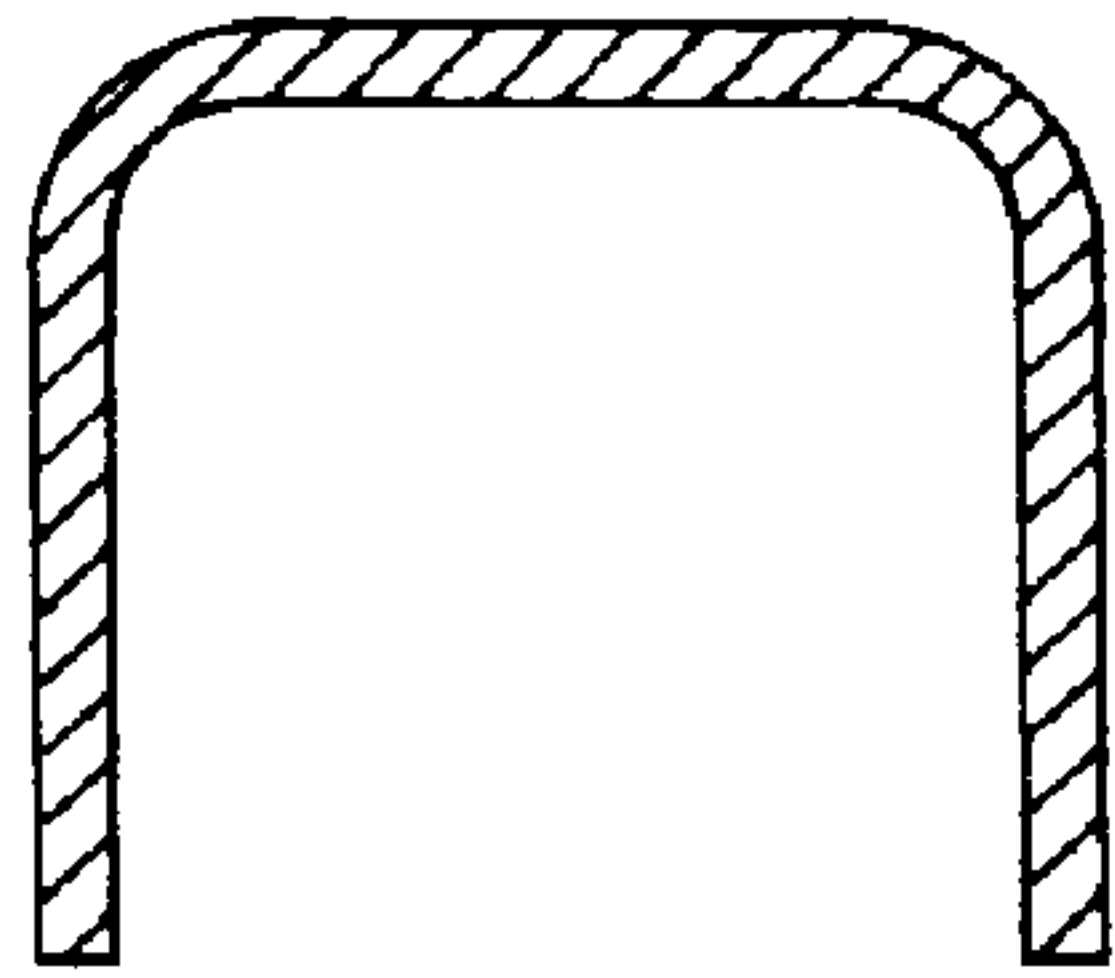

FIG. 14

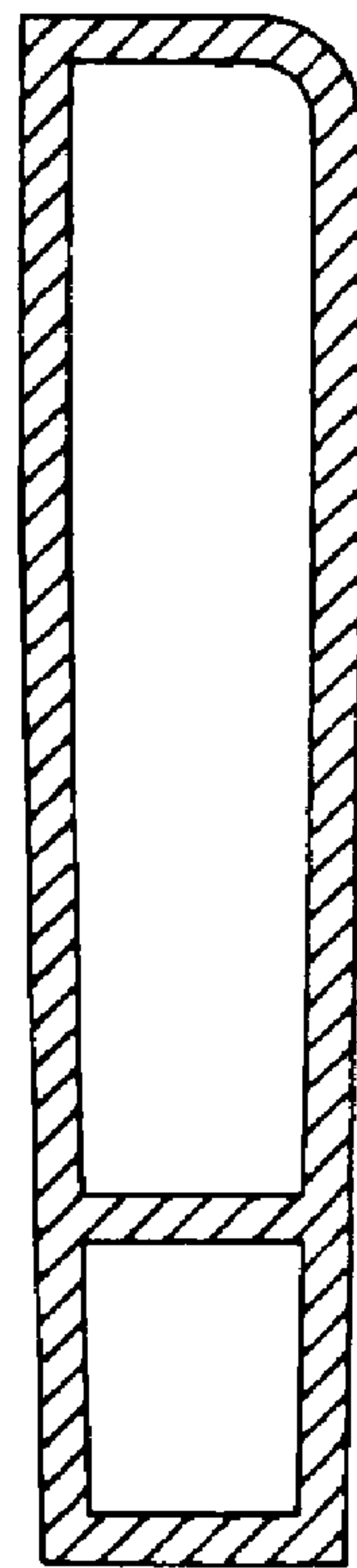

FIG. 15

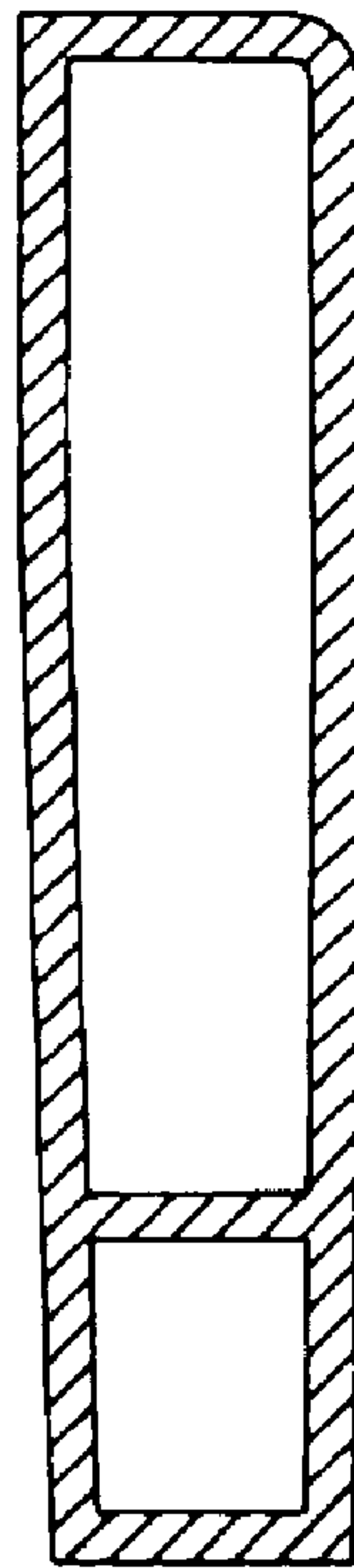

FIG. 16

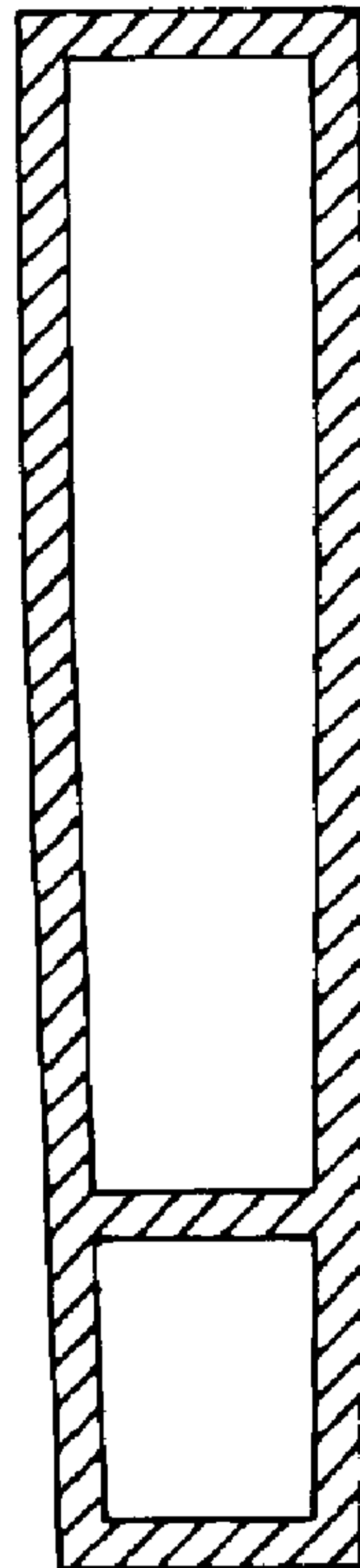

FIG. 17