



US00D517516S

(12) **United States Design Patent**
Peng

(10) **Patent No.:** **US D517,516 S**
(45) **Date of Patent:** **** Mar. 21, 2006**

- (54) **DVD MULTIMEDIA PLAYER**
- (75) Inventor: **Juen Tien Peng, Chung Li (TW)**
- (73) Assignee: **Action Electronics Co., Ltd., Chung Li (TW)**
- (**) Term: **14 Years**
- (21) Appl. No.: **29/215,694**
- (22) Filed: **Oct. 25, 2004**
- (51) **LOC (8) Cl.** **14-01**
- (52) **U.S. Cl.** **D14/136**
- (58) **Field of Classification Search** D14/135-136, D14/156-157, 160-165, 167-168, 192-198, D14/188, 217, 257, 258, 445; 360/99.02, 360/99.07; 369/75.11, 75.21, 77.21, 77.11; 720/612, 619, 647, 655; 455/344, 347-351
See application file for complete search history.

- D403,320 S * 12/1998 Niitsu D14/168
- 5,870,367 A * 2/1999 Yamamori 720/669
- D412,332 S * 7/1999 Yuyama D14/156
- D424,050 S * 5/2000 Sakamoto et al. D14/136
- D435,032 S * 12/2000 Zeitman D14/156

* cited by examiner

Primary Examiner—Nanda Bondade

(57) **CLAIM**

The ornamental design of a DVD multimedia player, as shown and described.

DESCRIPTION

- FIG. 1 is a perspective view of DVD multimedia player showing my design.
- FIG. 2 is a front elevational view thereof;
- FIG. 3 is rear elevational view thereof.
- FIG. 4 is left side elevational view thereof;
- FIG. 5 is a right side elevational view thereof;
- FIG. 6 is a top view thereof; and,
- FIG. 7 is a bottom view thereof.

(56) **References Cited**

U.S. PATENT DOCUMENTS

- D389,480 S * 1/1998 Niitsu D14/168

1 Claim, 4 Drawing Sheets

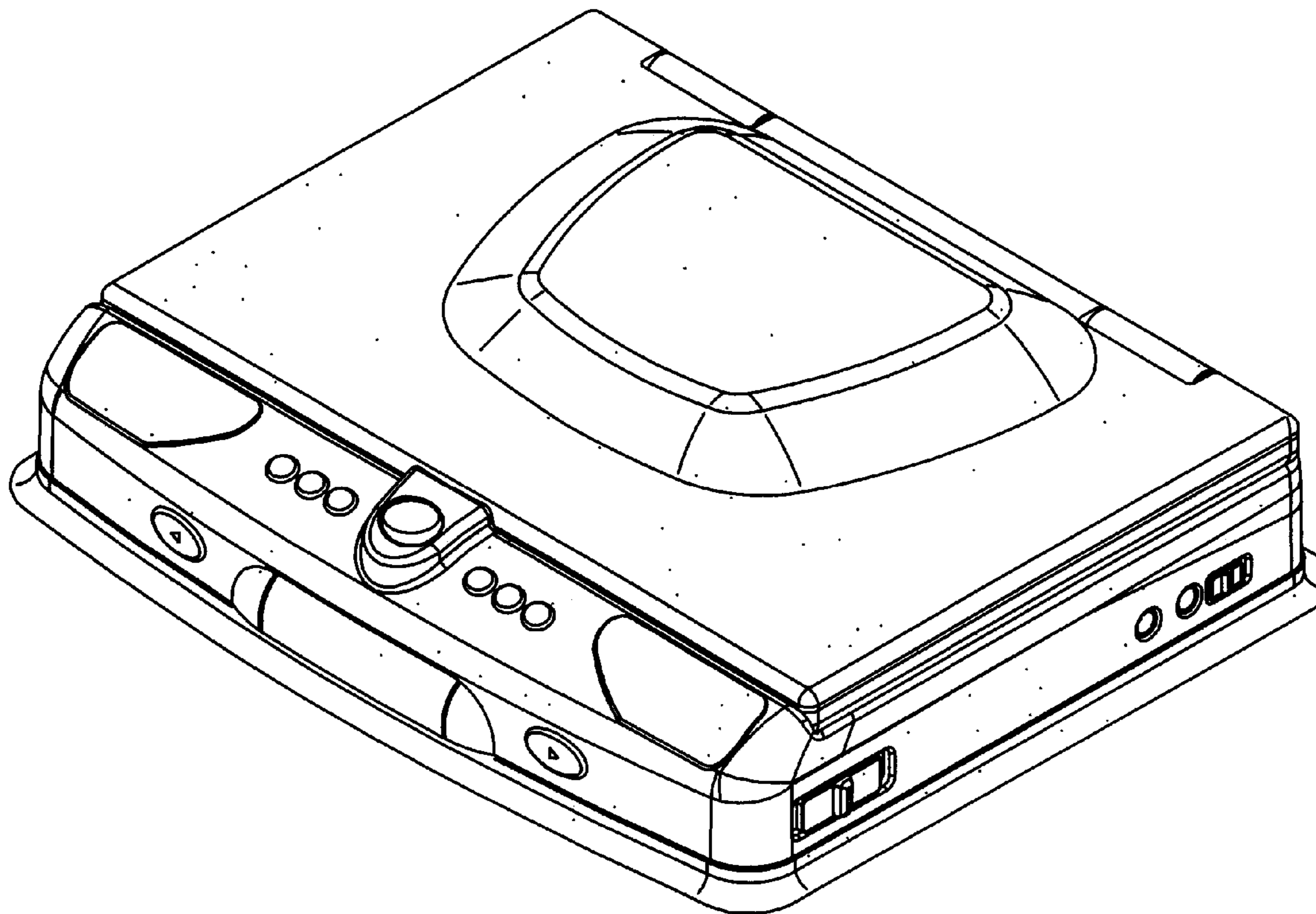

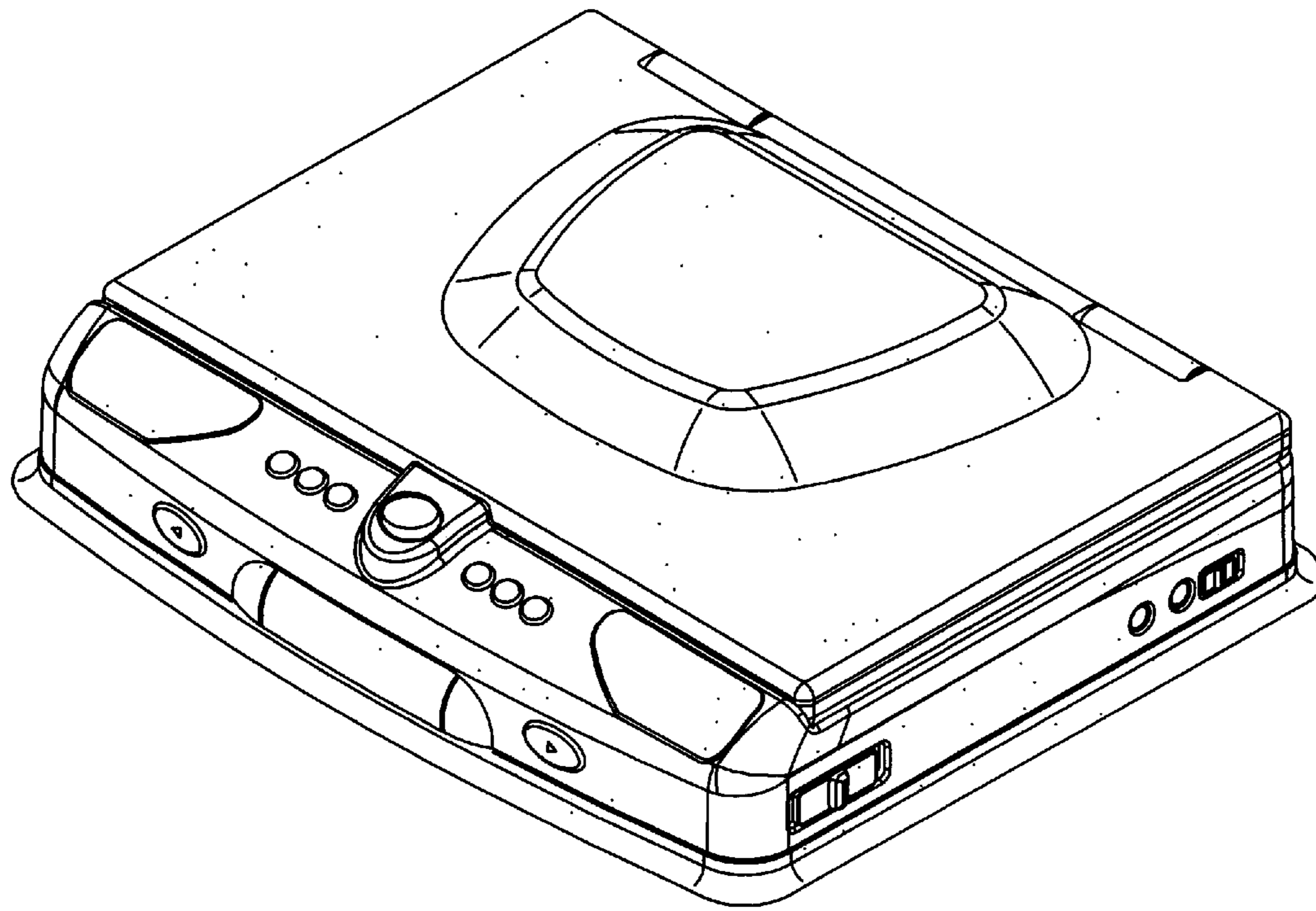

FIG. 1

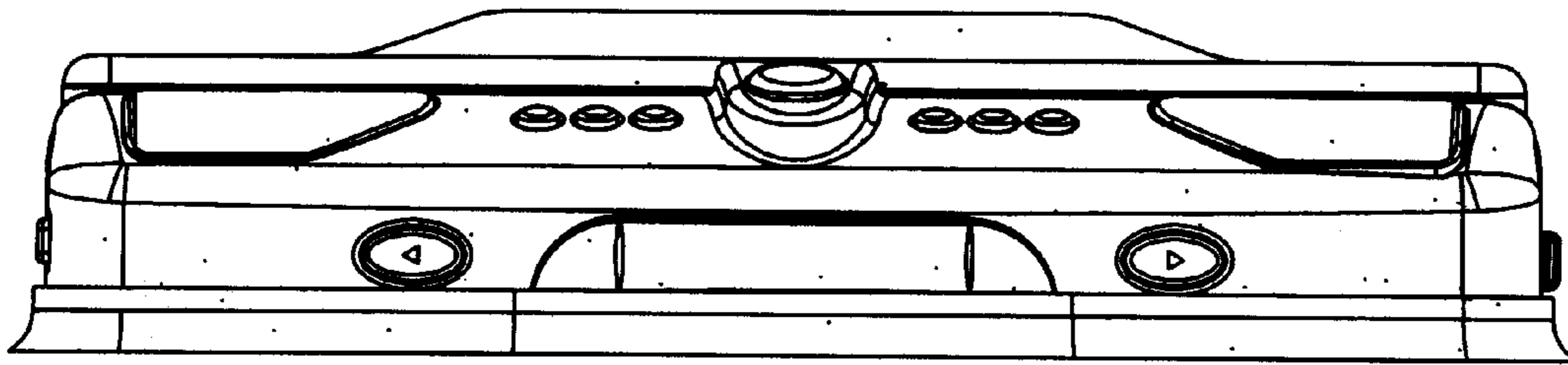

FIG. 2

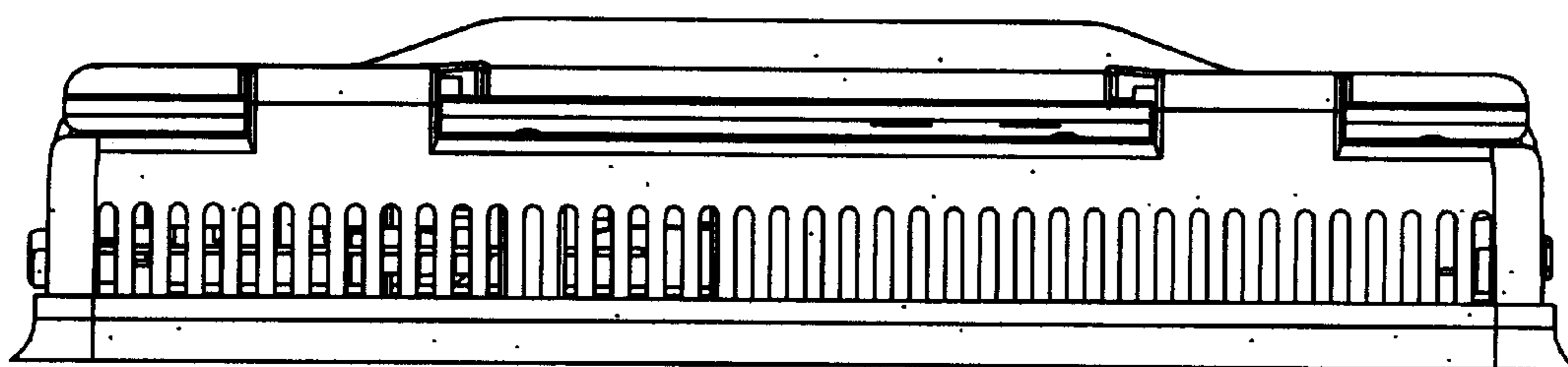

FIG. 3

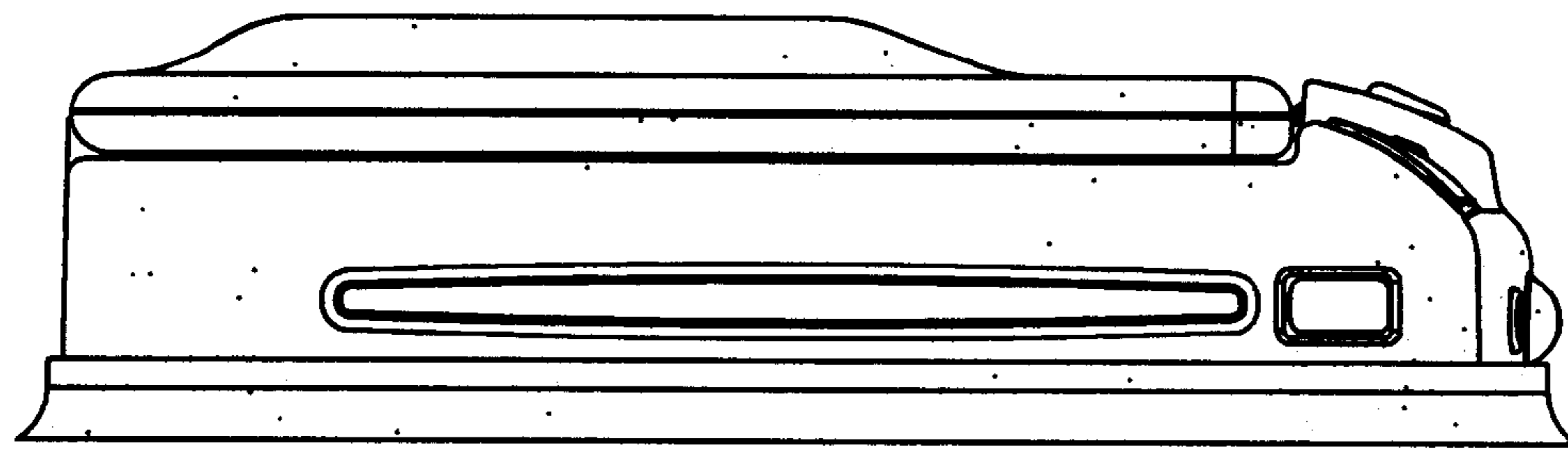

FIG. 4

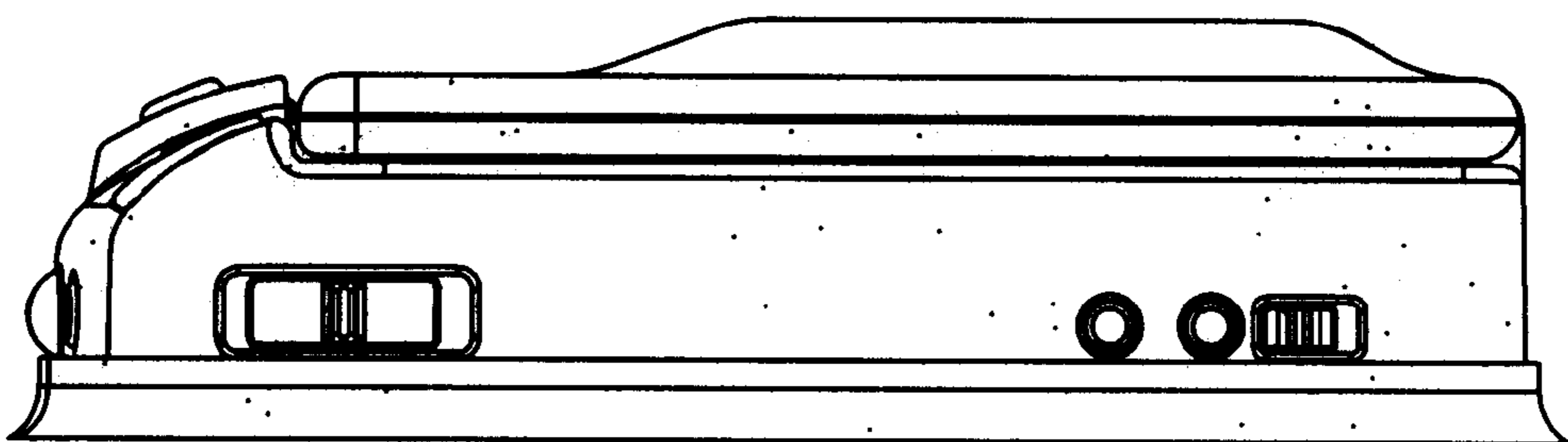

FIG. 5

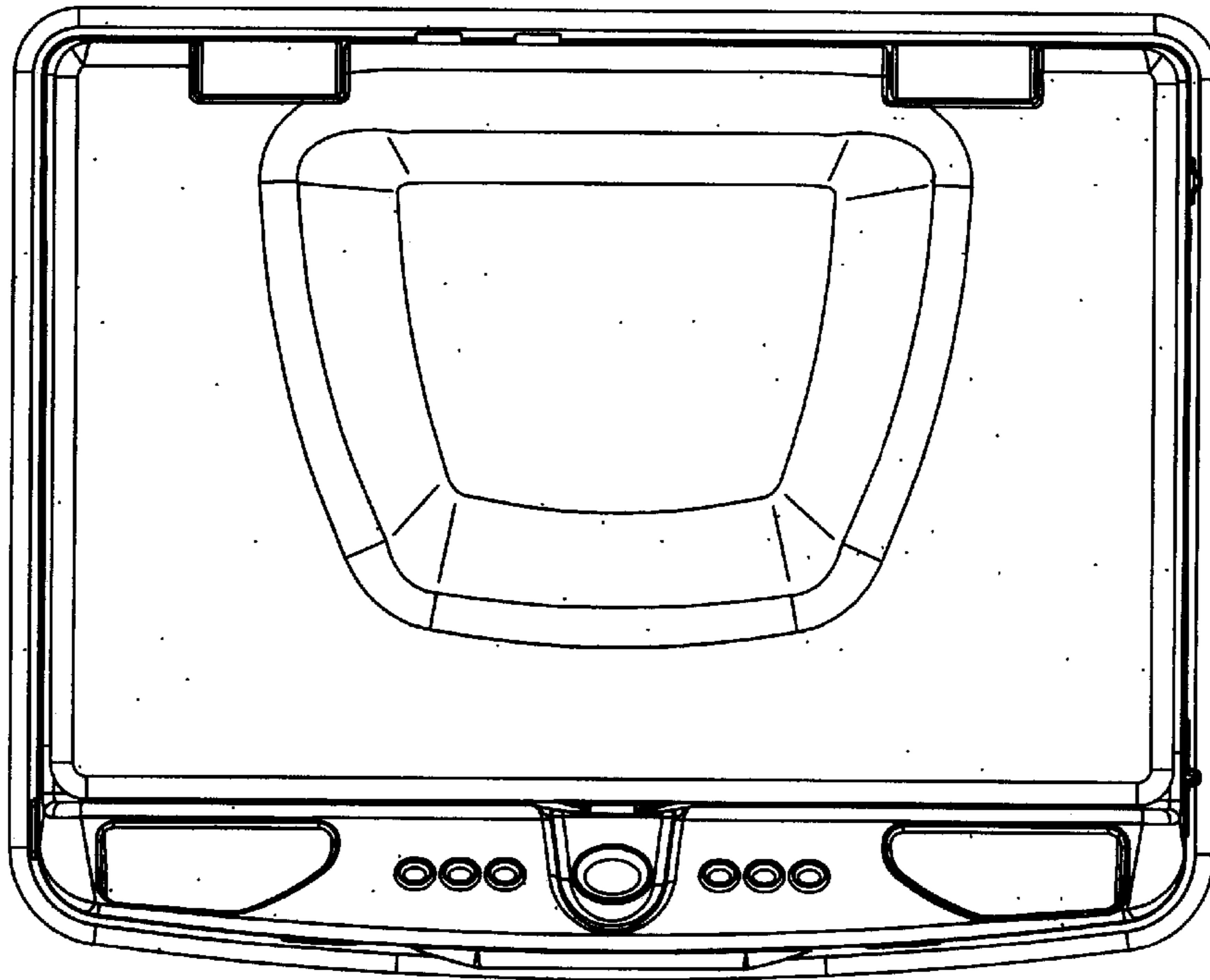

FIG. 6

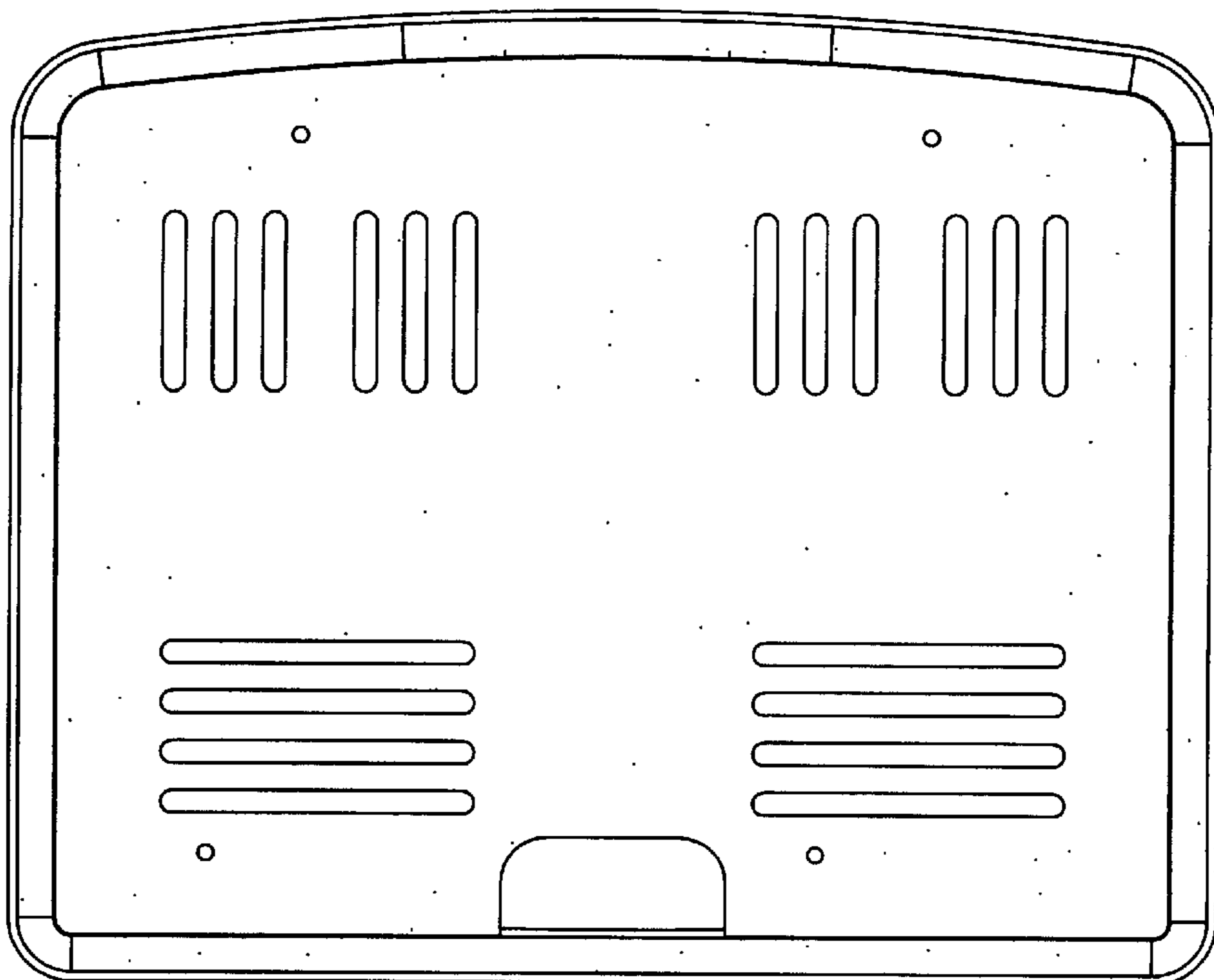

FIG. 7