



US00D517431S

(12) **United States Design Patent**  
**Chang**

(10) **Patent No.:** **US D517,431 S**  
(45) **Date of Patent:** **\*\* Mar. 21, 2006**

(54) **TRAVEL ALARM CLOCK WITH LEATHER CASE**

(76) **Inventor:** **Eddie Chang**, Unit C, 2/F, Leroy Plaza, 15 Cheung Shun St., Cheung Sha Wan, Kowloon (HK)

(\*\*) **Term:** **14 Years**

(21) **Appl. No.:** **29/213,468**

(22) **Filed:** **Sep. 18, 2004**

(30) **Foreign Application Priority Data**

Mar. 24, 2004 (HK) ..... 0410661

(51) **LOC (8) Cl.** ..... **10-01**

(52) **U.S. Cl.** ..... **D10/15; D10/18**

(58) **Field of Classification Search** ..... D10/1-29, D10/122-132; 368/276-278, 280, 284, 285, 368/286, 316, 317, 294, 10, 82-84, 28-30, 368/239-242, 63, 72, 73

See application file for complete search history.

(56) **References Cited**

**U.S. PATENT DOCUMENTS**

- 1,765,971 A \* 6/1930 Earl ..... 368/316
- D96,553 S \* 8/1935 Irelan ..... D10/128
- 2,013,575 A \* 9/1935 Moffatt ..... 368/277
- 2,567,564 A \* 9/1951 Ingraham ..... 368/316
- 3,552,117 A \* 1/1971 Parris ..... 368/277
- D269,414 S \* 6/1983 Sugano ..... D10/18
- D319,394 S \* 8/1991 Mayuzumi ..... D10/18
- D334,347 S \* 3/1993 White ..... D10/37

\* cited by examiner

*Primary Examiner*—Lucy Lieberman

(74) *Attorney, Agent, or Firm*—Robert M. Downey, PA

(57) **CLAIM**

The ornamental design for a travel alarm clock with leather case, as shown and described.

**DESCRIPTION**

FIG. 1 is a top perspective view of a travel alarm clock with leather case showing my new design, and wherein the case is shown closed;

FIG. 2 is a top plan view of the travel alarm clock with leather case of FIG. 1;

FIG. 3 is a bottom plan view thereof;

FIG. 4 is a rear elevational view thereof;

FIG. 5 is a front elevational view thereof;

FIG. 6 is a right end elevational view thereof;

FIG. 7 is a left end elevational view thereof;

FIG. 8 is top front perspective view of the travel alarm clock with leather case shown with the case opened to display the clock face;

FIG. 9 is a front elevational view thereof;

FIG. 10 is a rear elevational view thereof;

FIG. 11 is a right end elevational view thereof;

FIG. 12 is a left end elevational view thereof;

FIG. 13 is a top plan view thereof;

FIG. 14 is a bottom plan view thereof;

FIG. 15 is a top plan view of the travel alarm clock with leather case, shown with the leather case fully stretched open along a single plane; and,

FIG. 16 is a bottom plan view of the travel alarm clock with leather case shown in FIG. 15.

The broken lines showing indicia on the face of the clock in FIGS. 8 and 15 are for illustrative purposes only and do not form part of the claimed design.

**1 Claim, 5 Drawing Sheets**

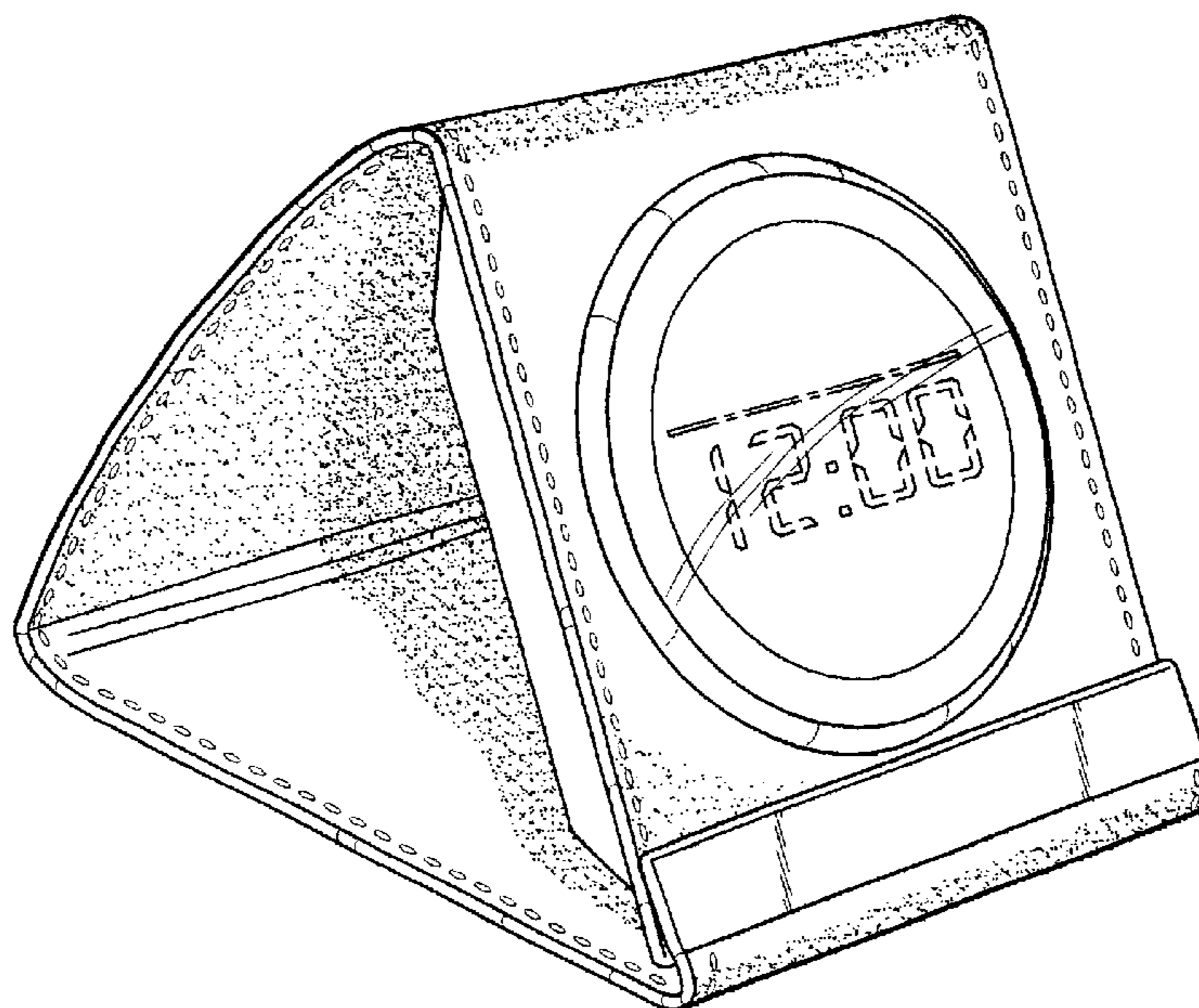

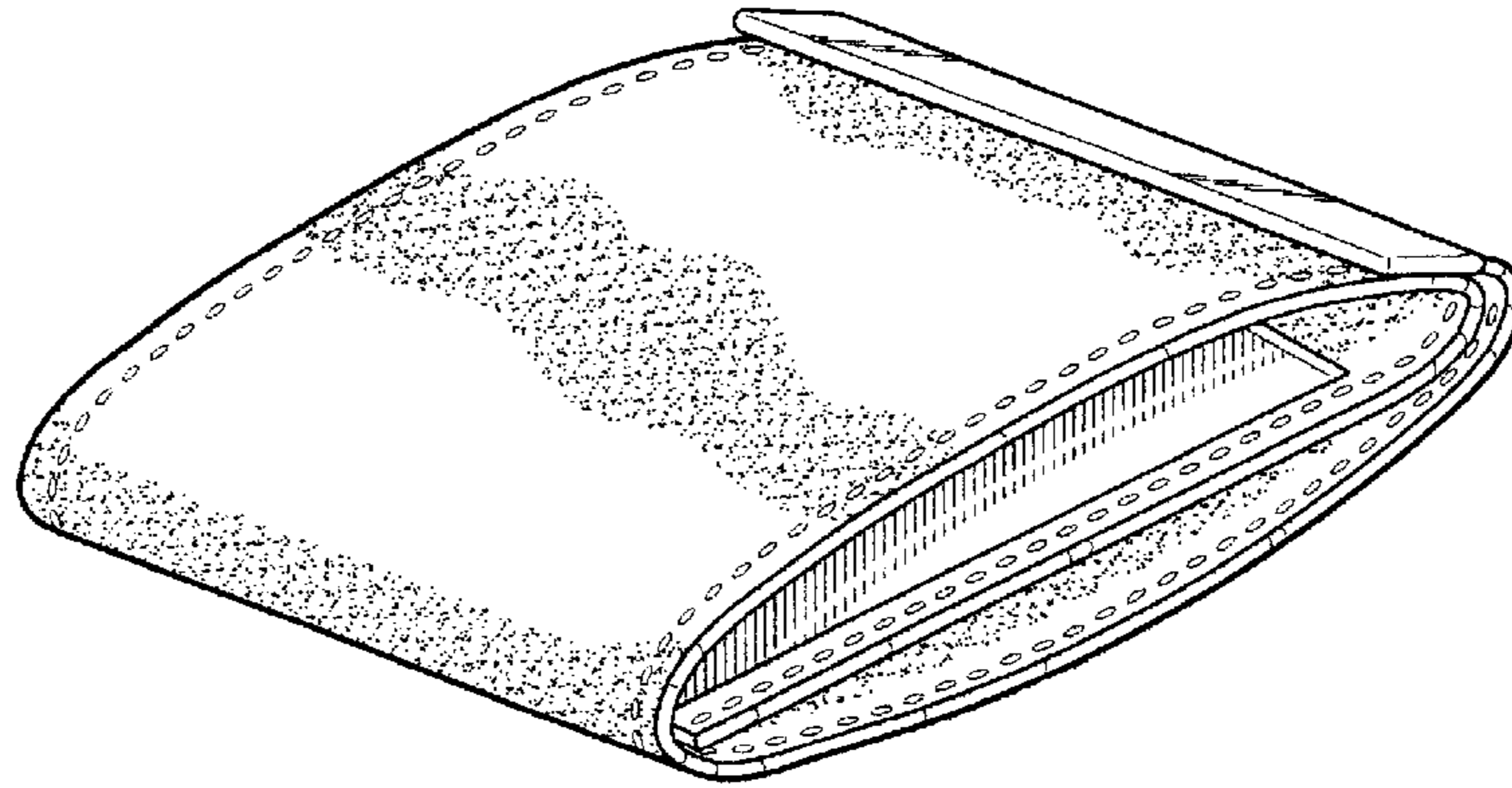

FIG. 1

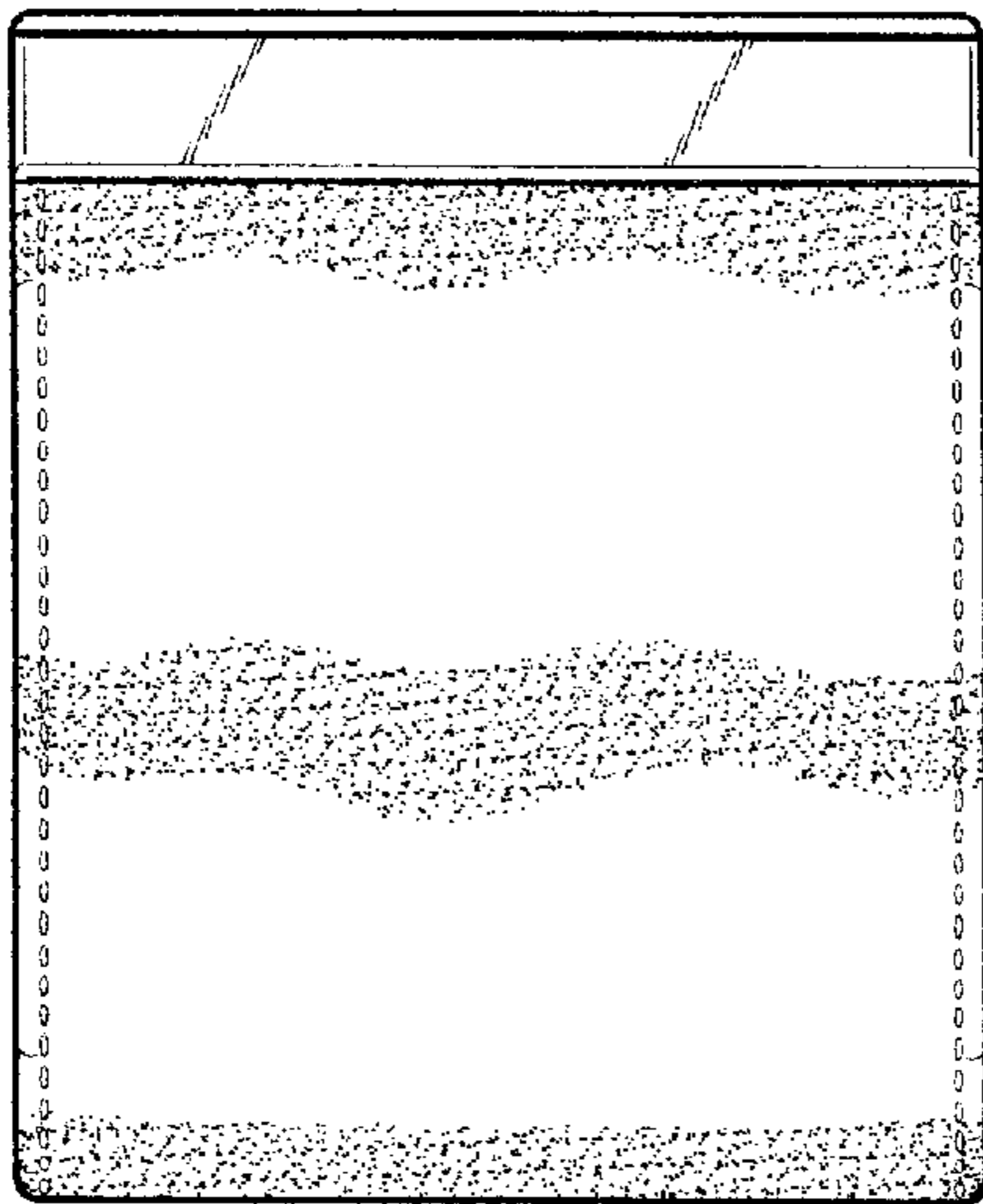

FIG. 2

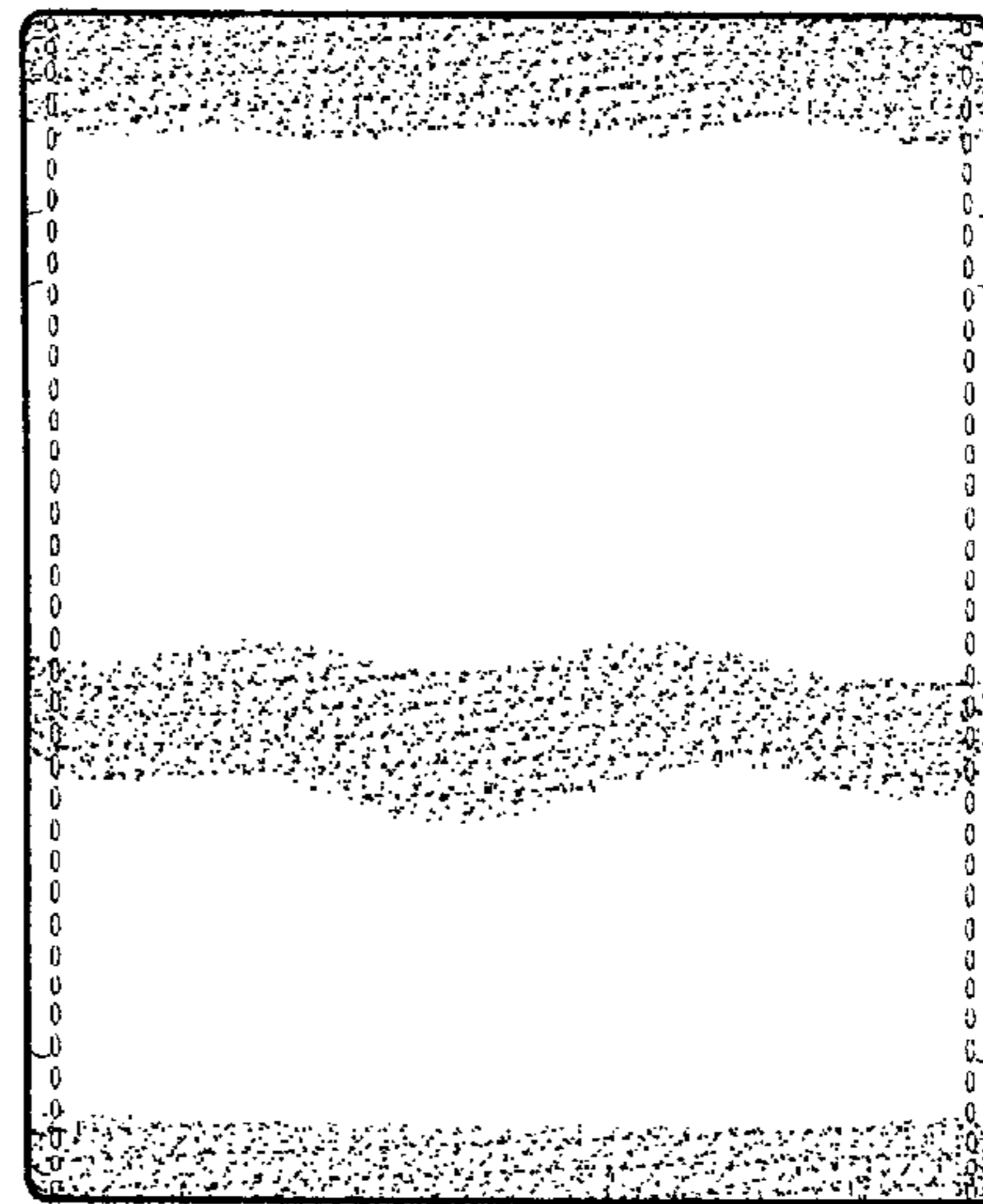

FIG. 3

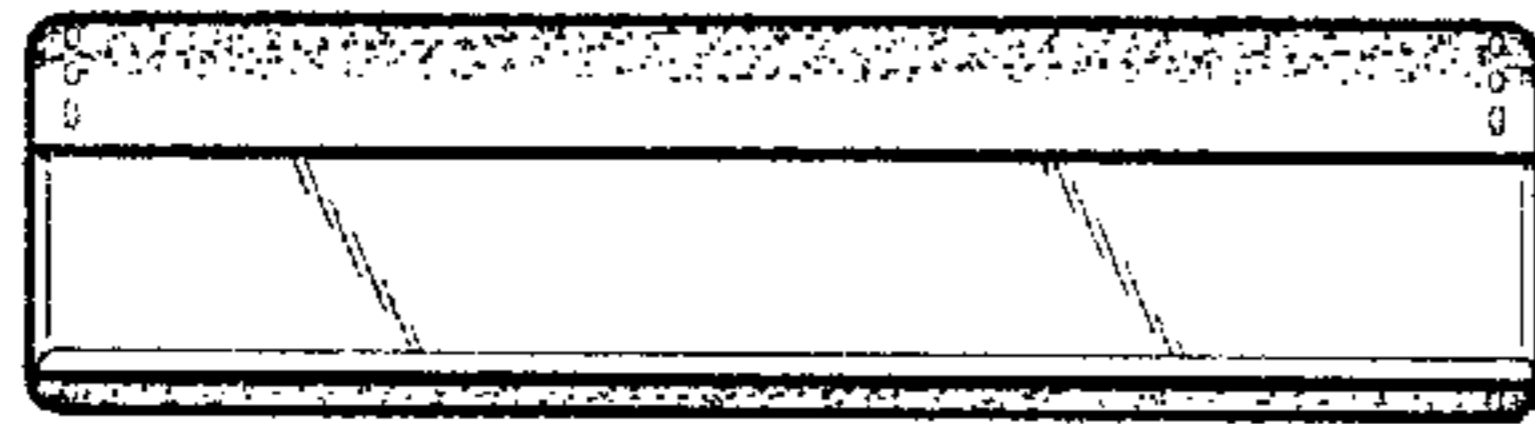

FIG. 4

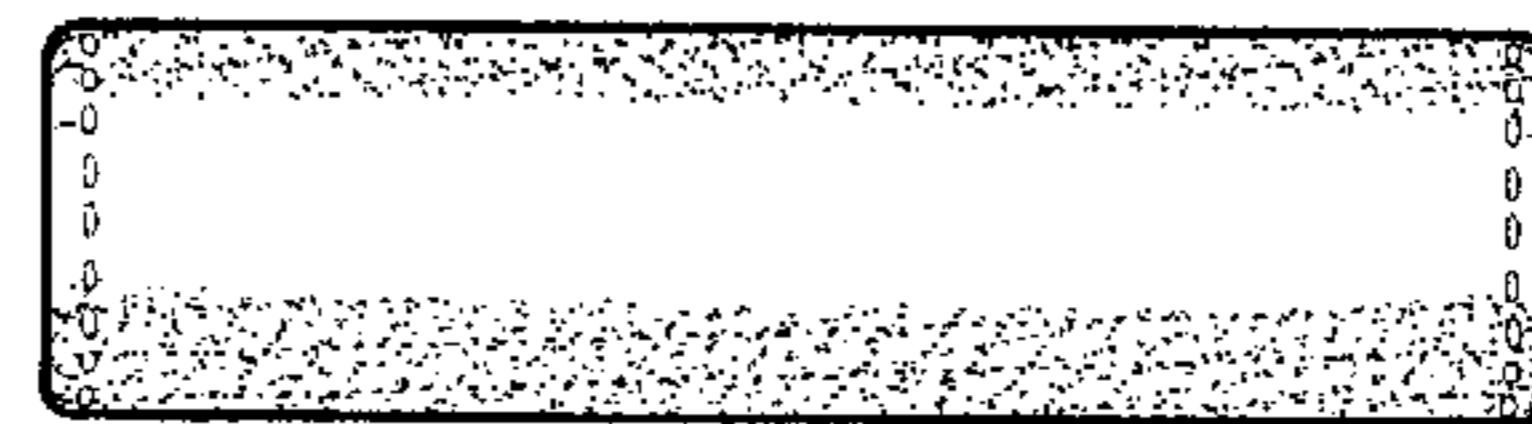

FIG. 5



FIG. 6

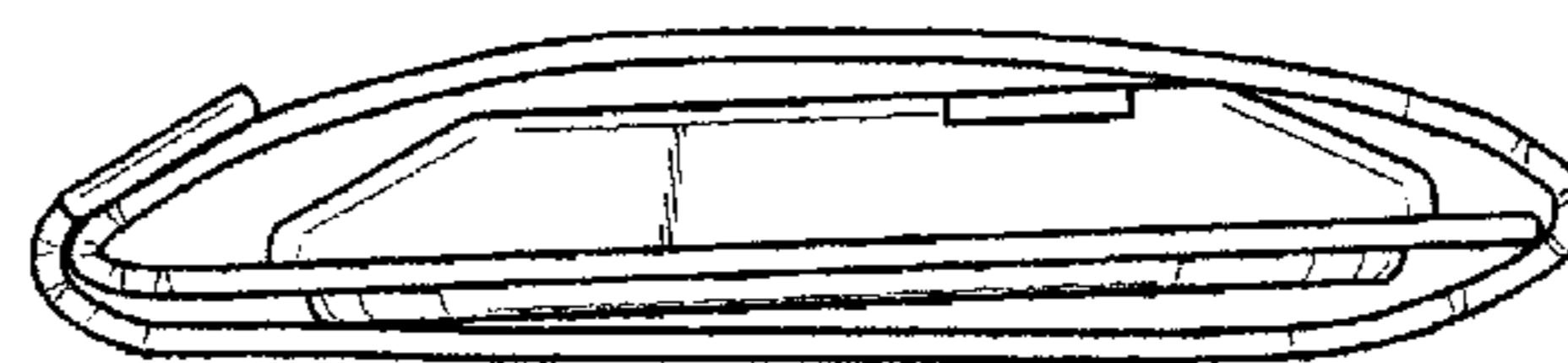

FIG. 7



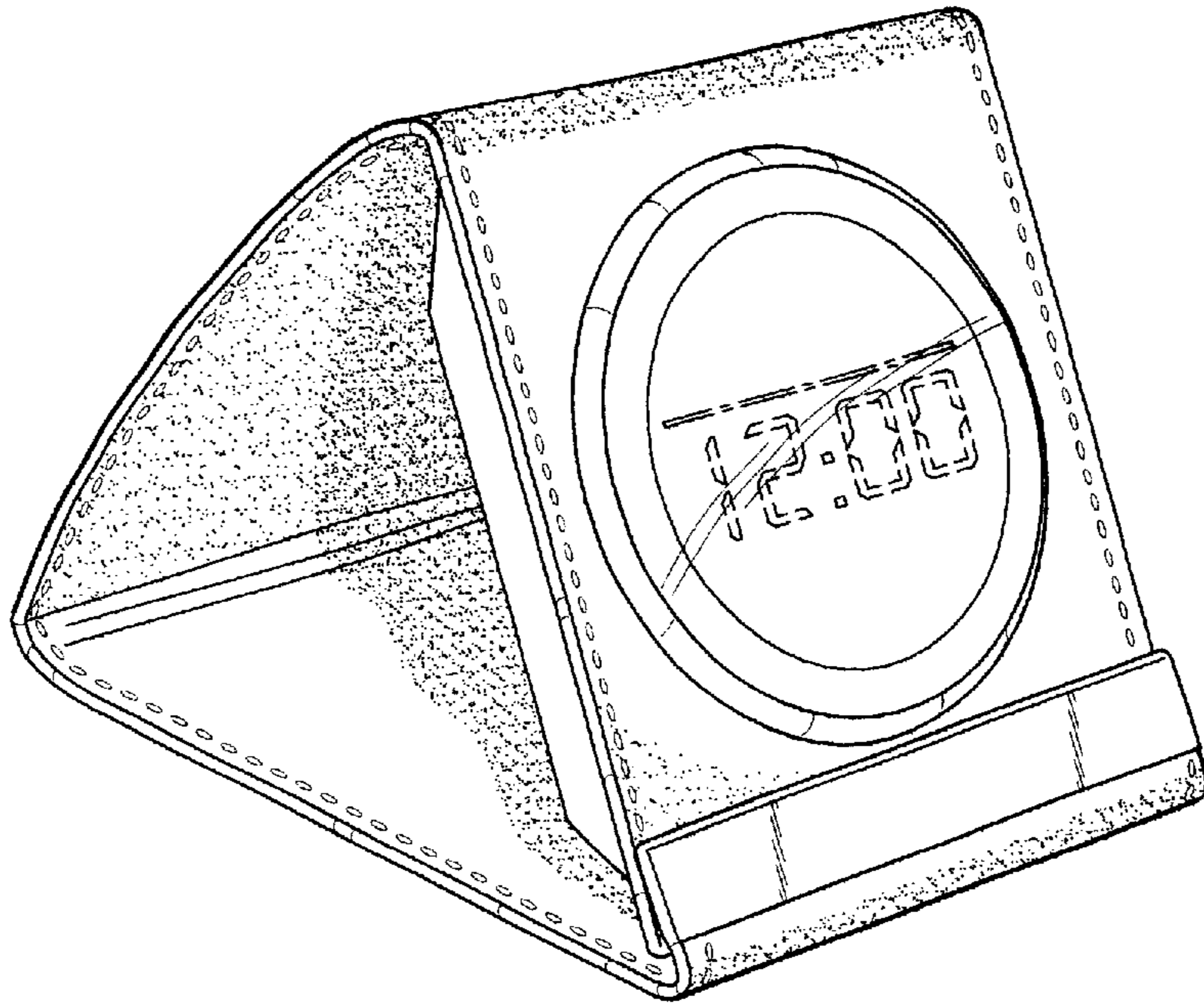

FIG. 8

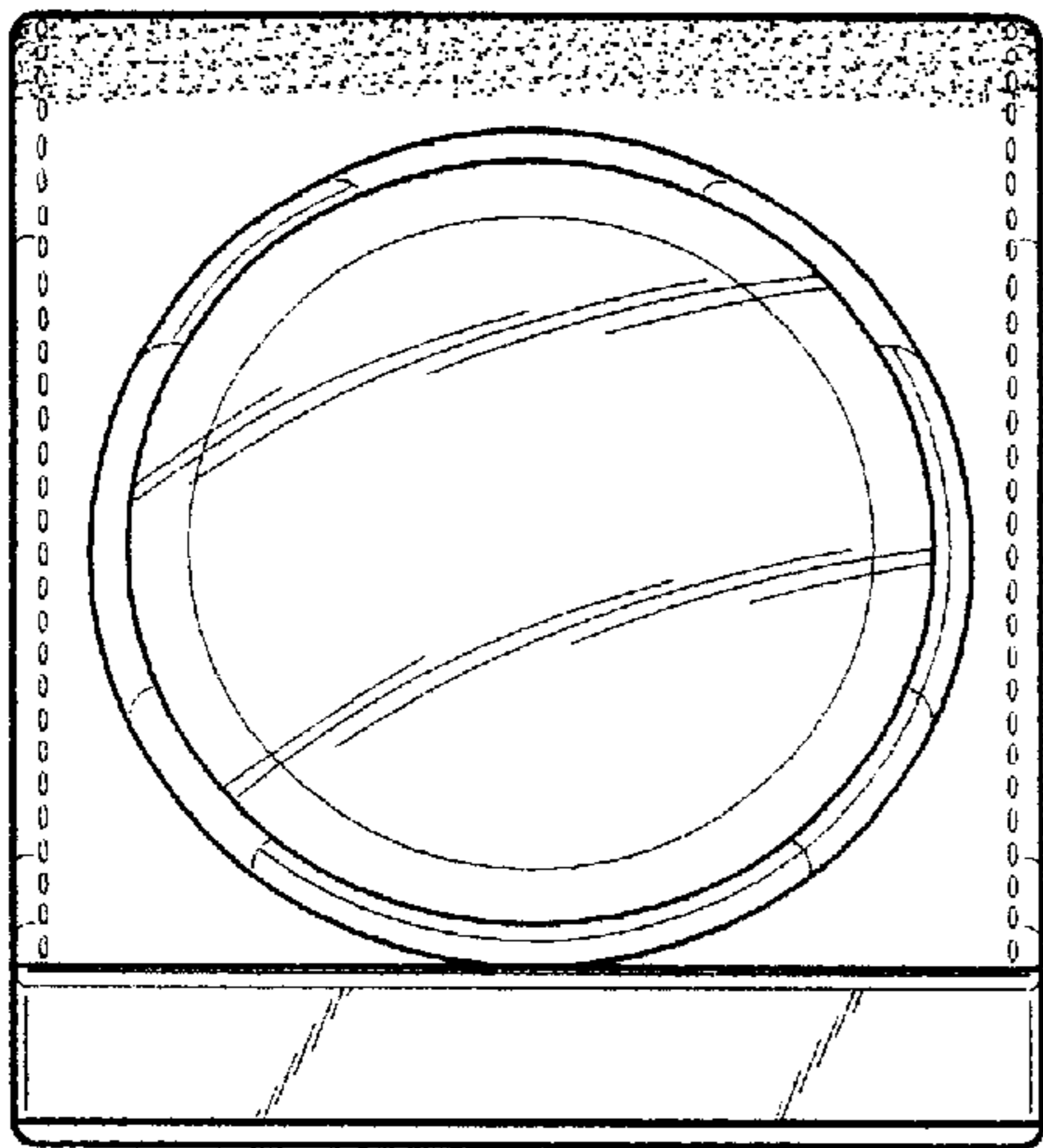

FIG. 9

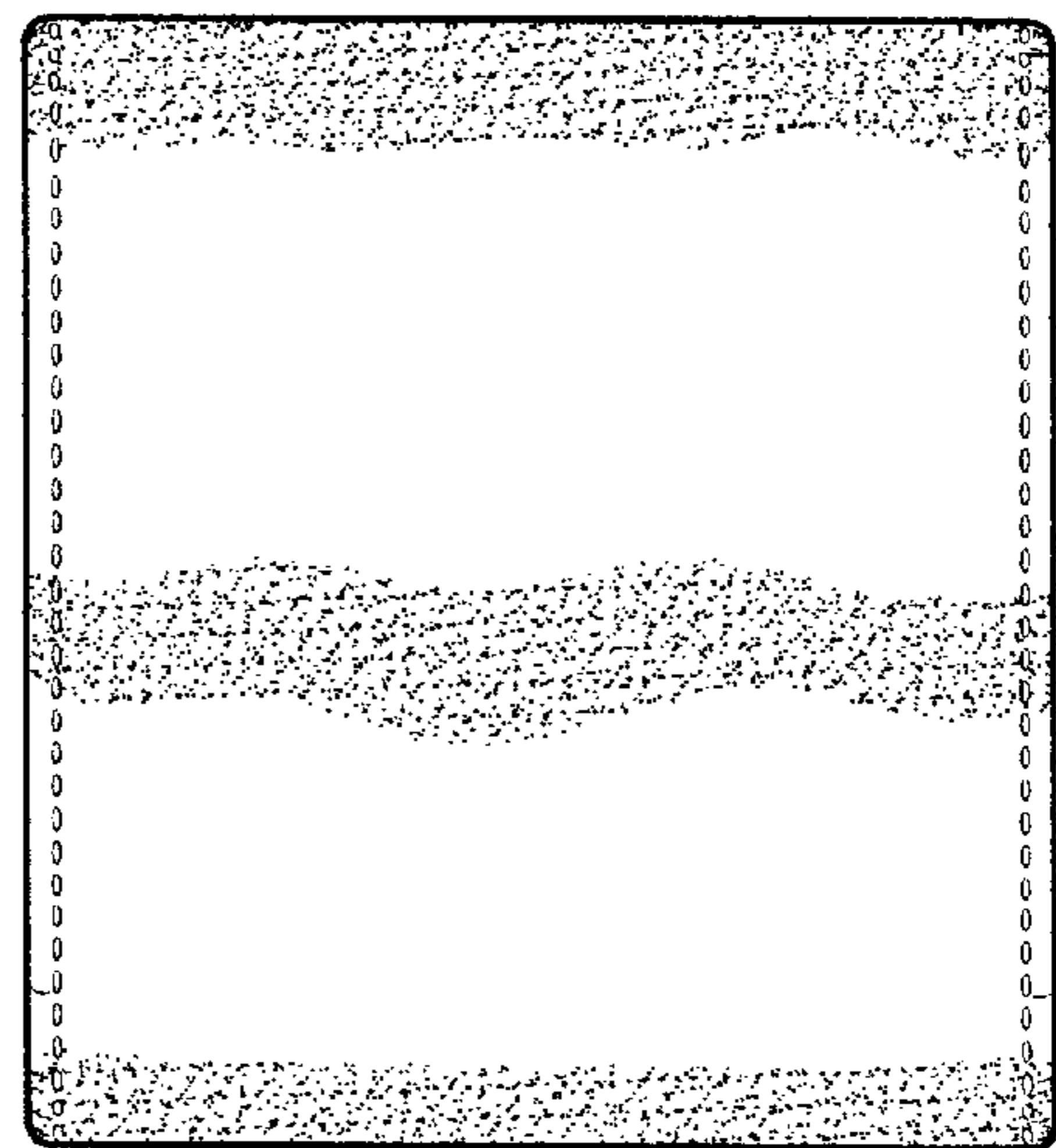

FIG. 10

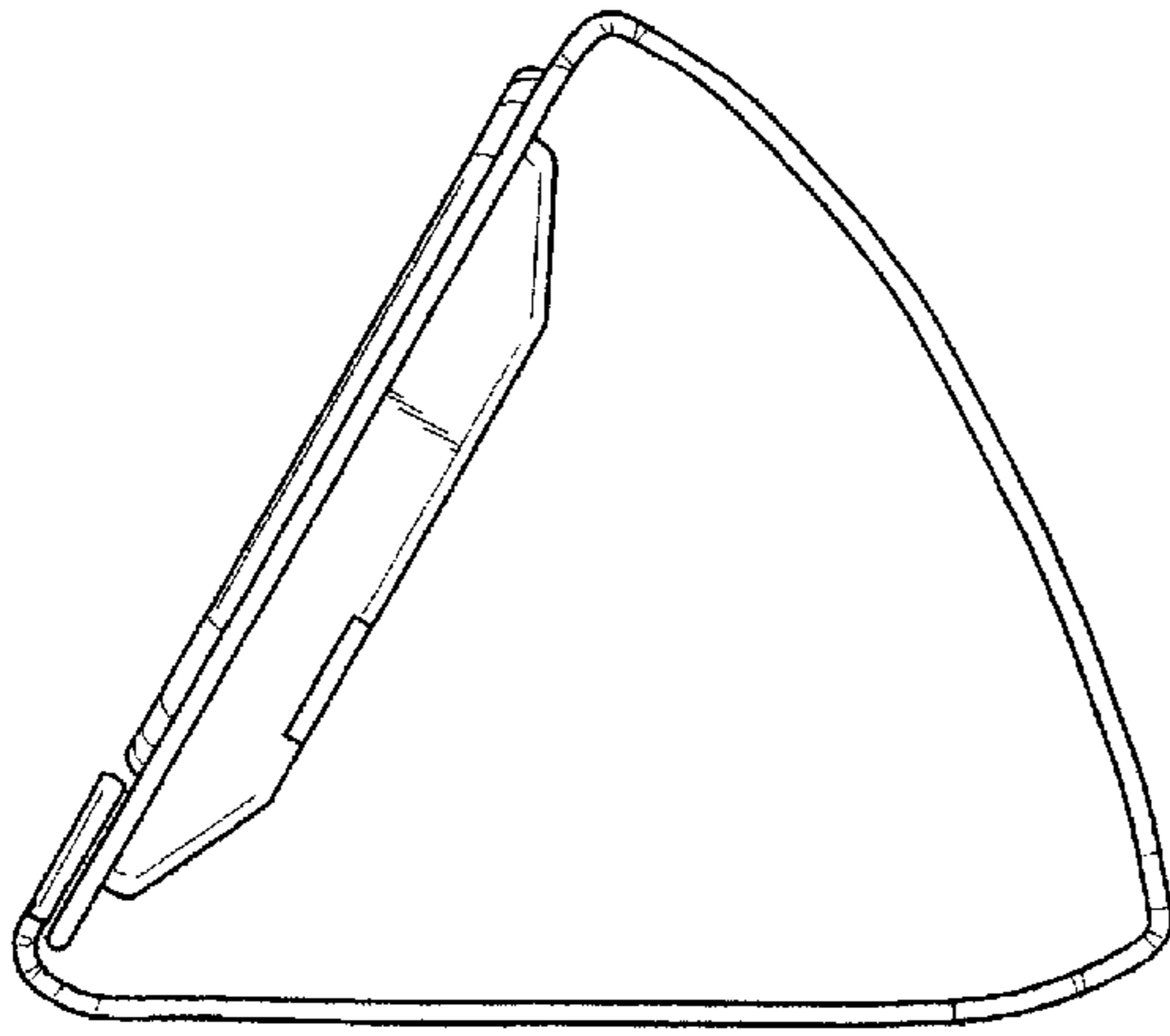

FIG. 11

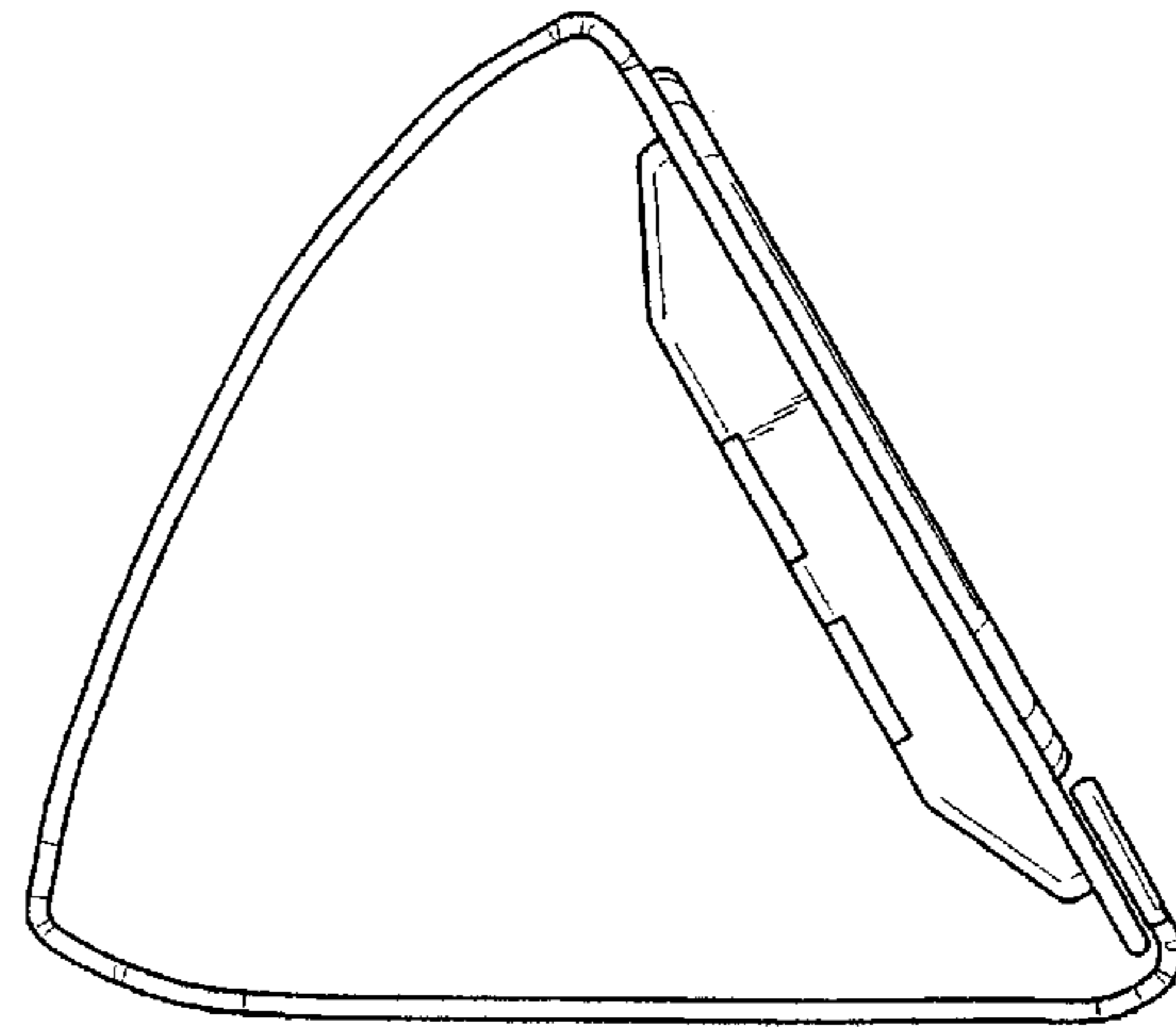

FIG. 12

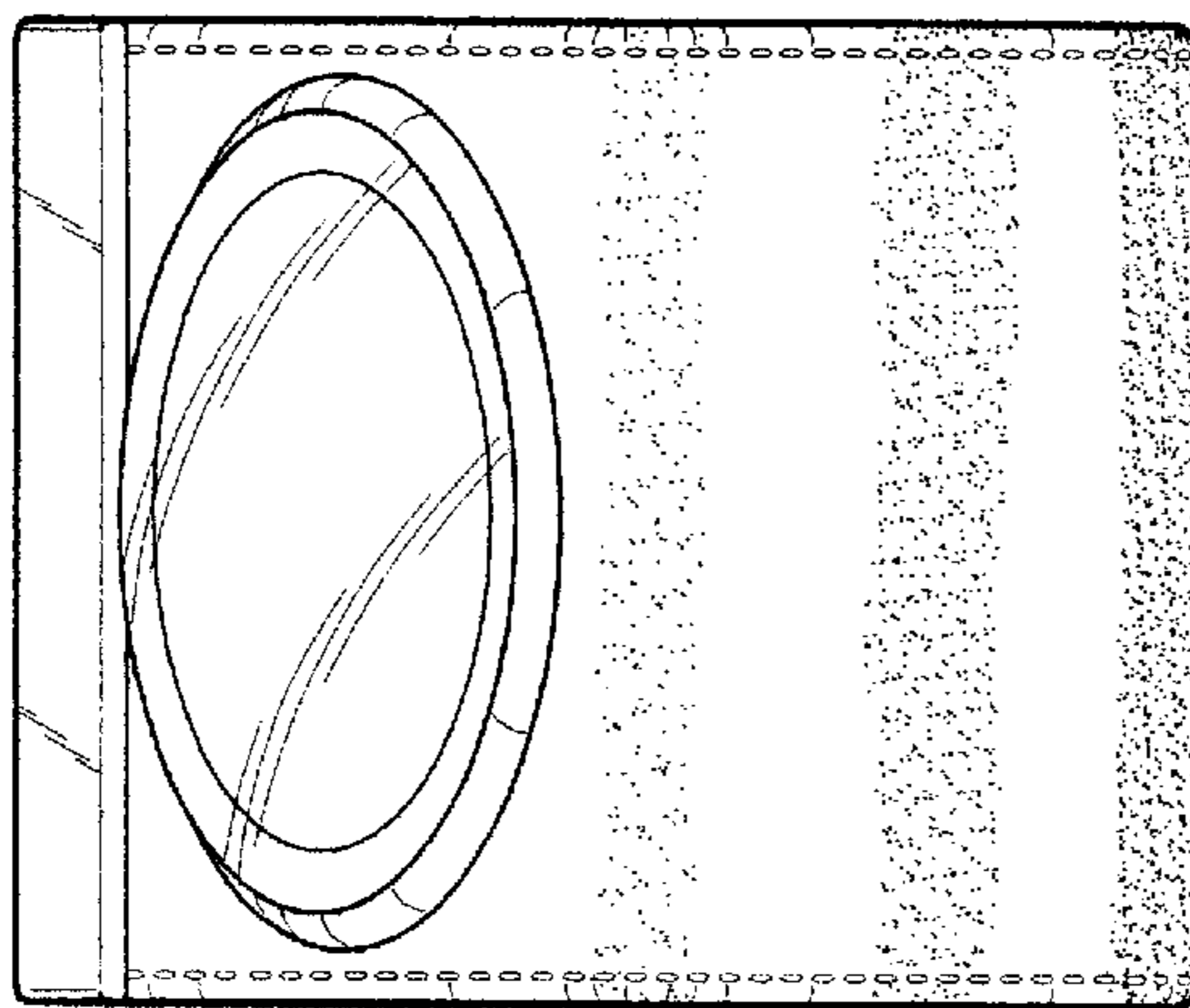

FIG. 13

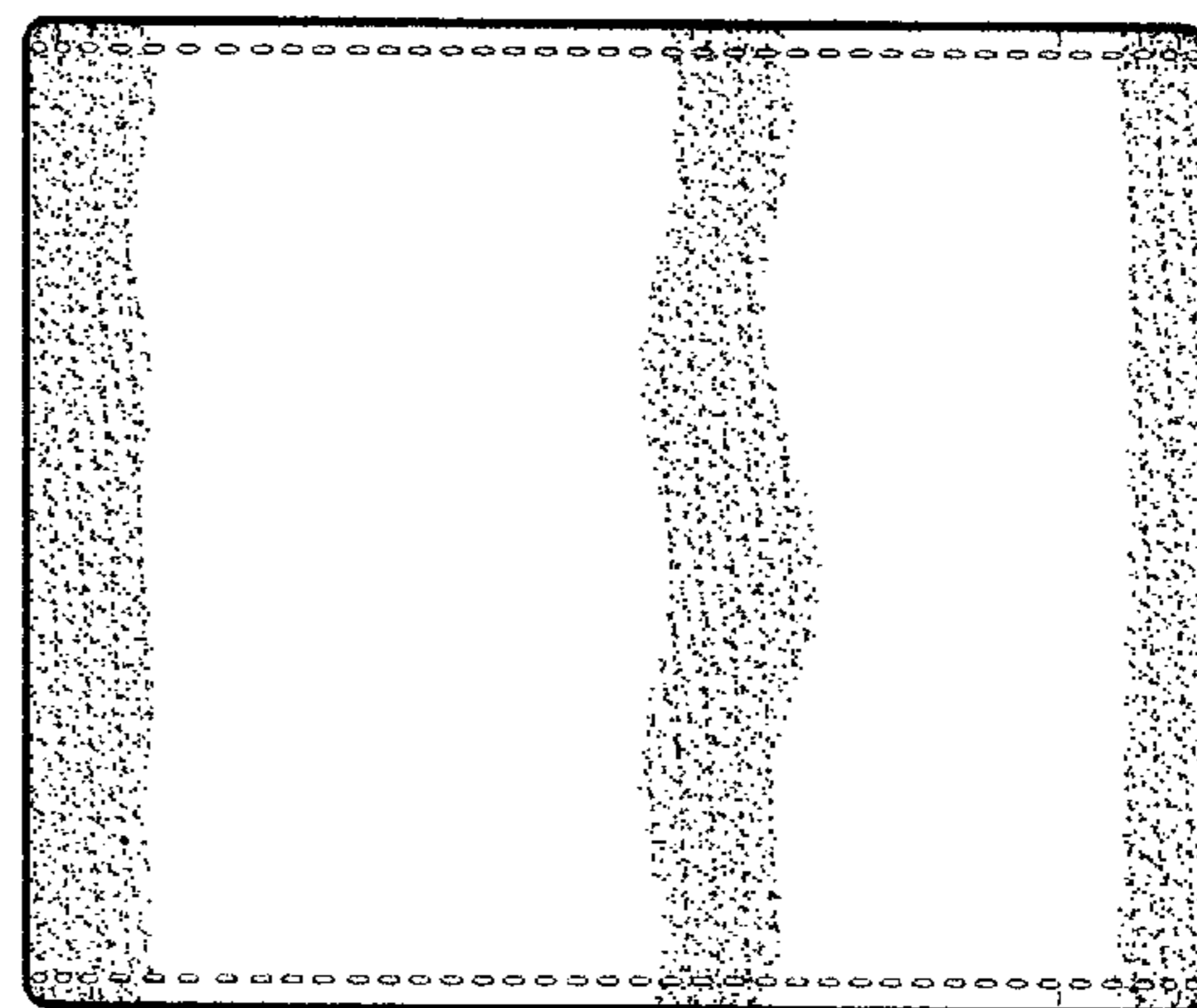

FIG. 14

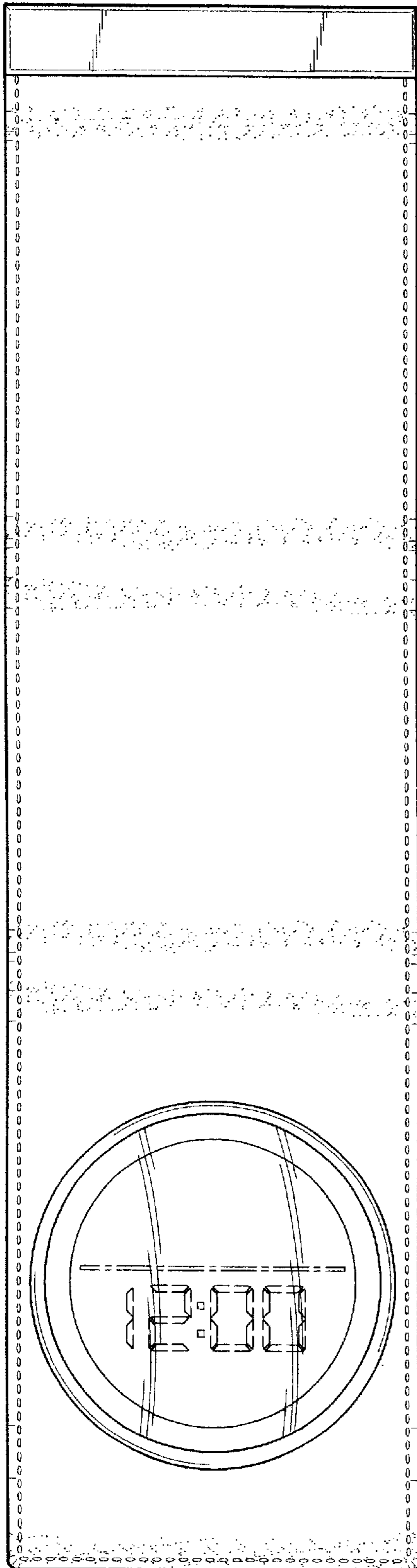

FIG. 15

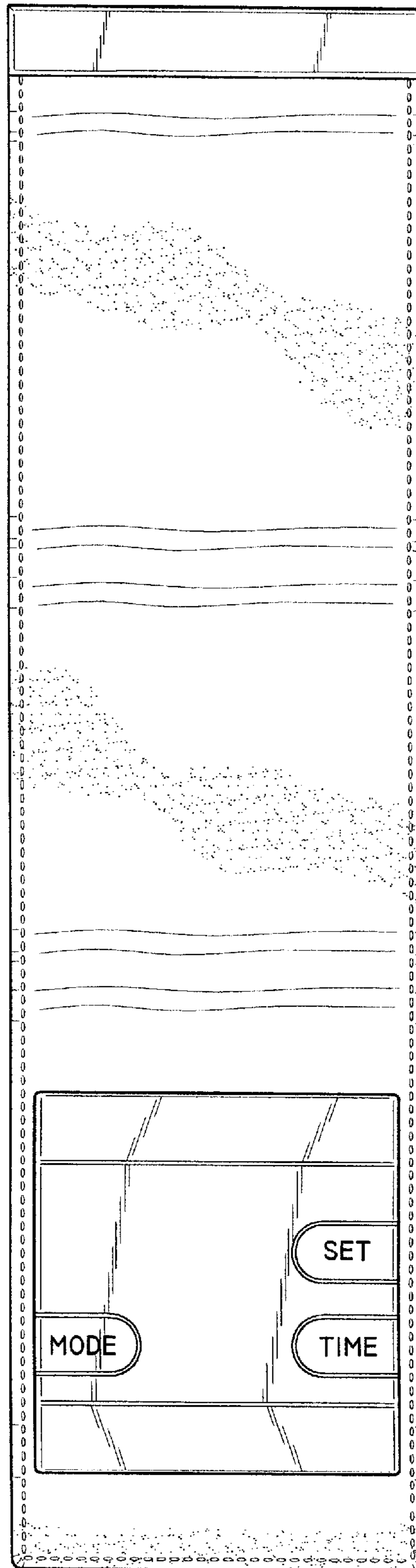

FIG. 16