

US00D517393S

(12) **United States Design Patent**
Chen

(10) **Patent No.:** **US D517,393 S**

(45) **Date of Patent:** **** Mar. 21, 2006**

(54) **TOOL HANDLE**

6,629,331 B1 * 10/2003 Panfili et al. 15/236.06
6,732,395 B1 * 5/2004 Gringer 15/105

(75) Inventor: **Chun Yong Chen**, Taipei (TW)

* cited by examiner

(73) Assignee: **Nieh Chaung Industrial Co., Ltd.**,
Taipei (TW)

Primary Examiner—Pamela Burgess

(74) *Attorney, Agent, or Firm*—Troxell Law Office, PLLC

(**) Term: **14 Years**

(57) **CLAIM**

(21) Appl. No.: **29/205,404**

The ornamental design for a tool handle, as shown and described.

(22) Filed: **May 14, 2004**

DESCRIPTION

(51) **LOC (8) Cl.** **08-05**

(52) **U.S. Cl.** **D8/107; D32/48**

(58) **Field of Classification Search** D8/107,
D8/45, 47, 98, 83; D7/395, 393, 401.2, 649;
16/110.1, 430–431; 15/143.1, 236.01, 236.06,
15/105; 30/169; D32/48–49; 220/752–753
See application file for complete search history.

FIG. 1 is a perspective view of the tool handle showing the new design;

FIG. 2 is a front view of the new design;

FIG. 3 is a rear view of the new design;

FIG. 4 is a left view of the new design;

FIG. 5 is a right view of the new design;

FIG. 6 is a top view of the new design;

FIG. 7 is a bottom view of the new design; and,

FIG. 8 is a perspective view showing the application thereof, wherein the broken line portion is for illustrative purpose only and forms no part of the claimed design.

(56) **References Cited**

U.S. PATENT DOCUMENTS

D305,818 S * 1/1990 Chen D32/48
D368,999 S * 4/1996 Chen D32/48
D453,251 S * 1/2002 Gringer et al. D32/48

1 Claim, 5 Drawing Sheets

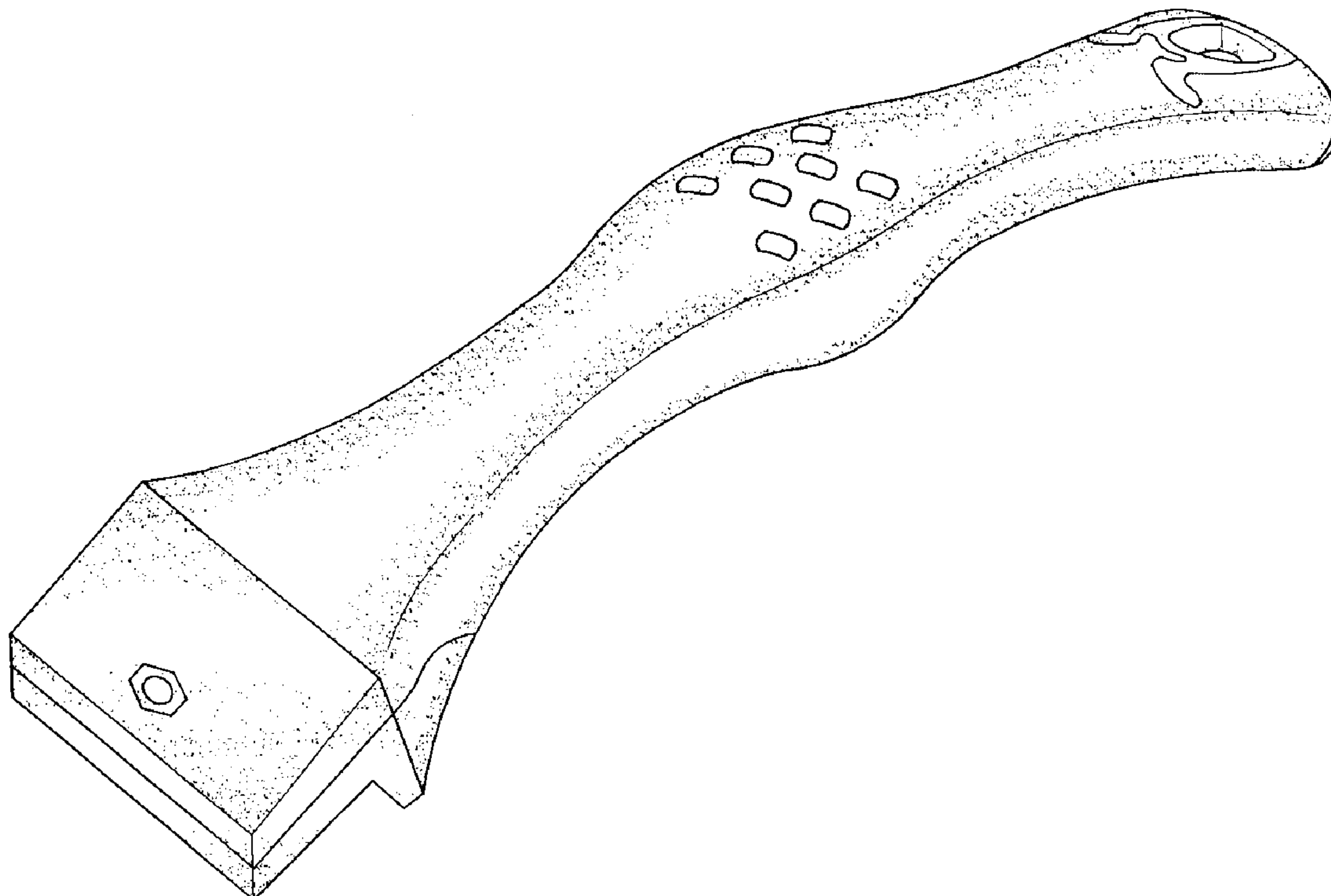

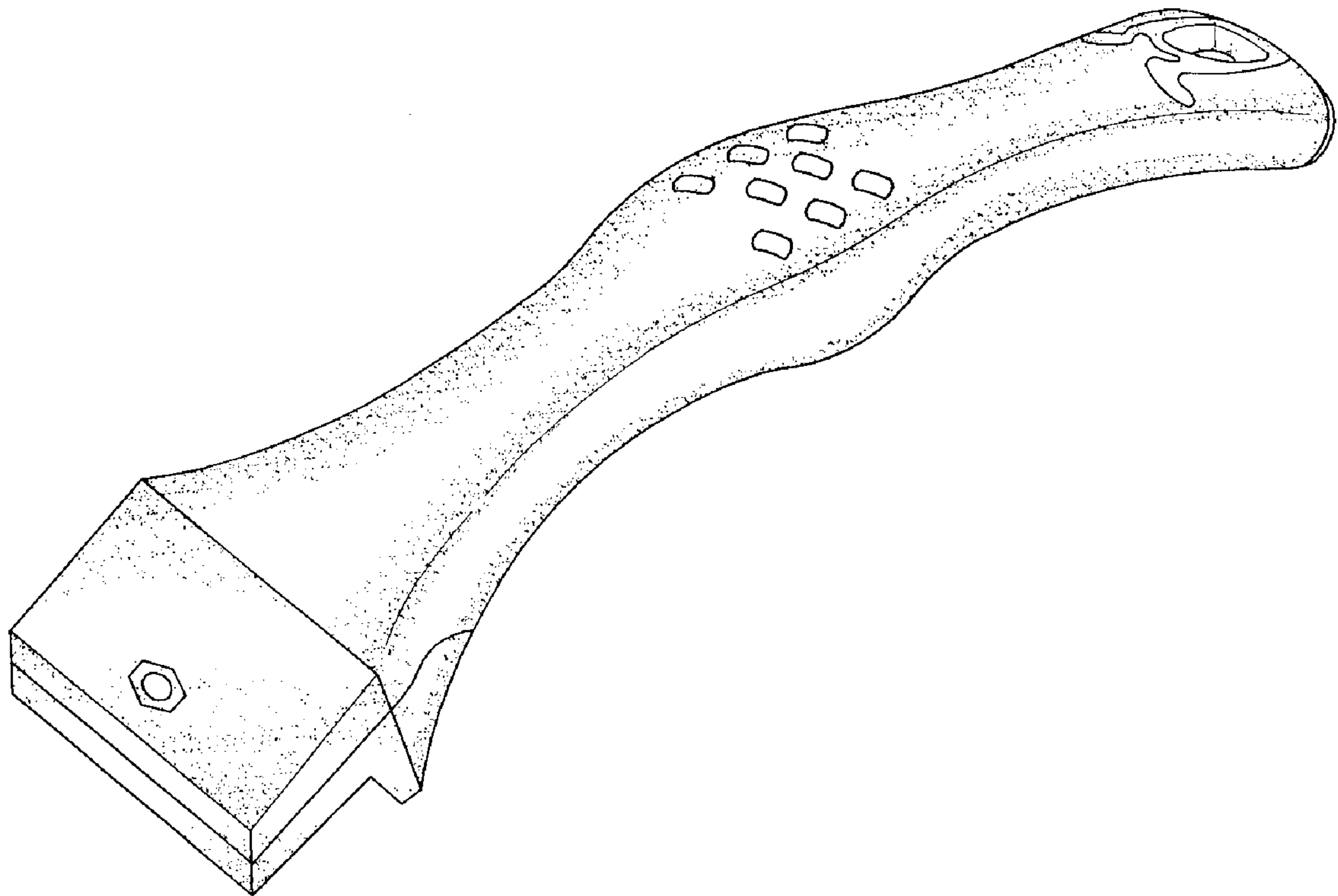

Fig. 1

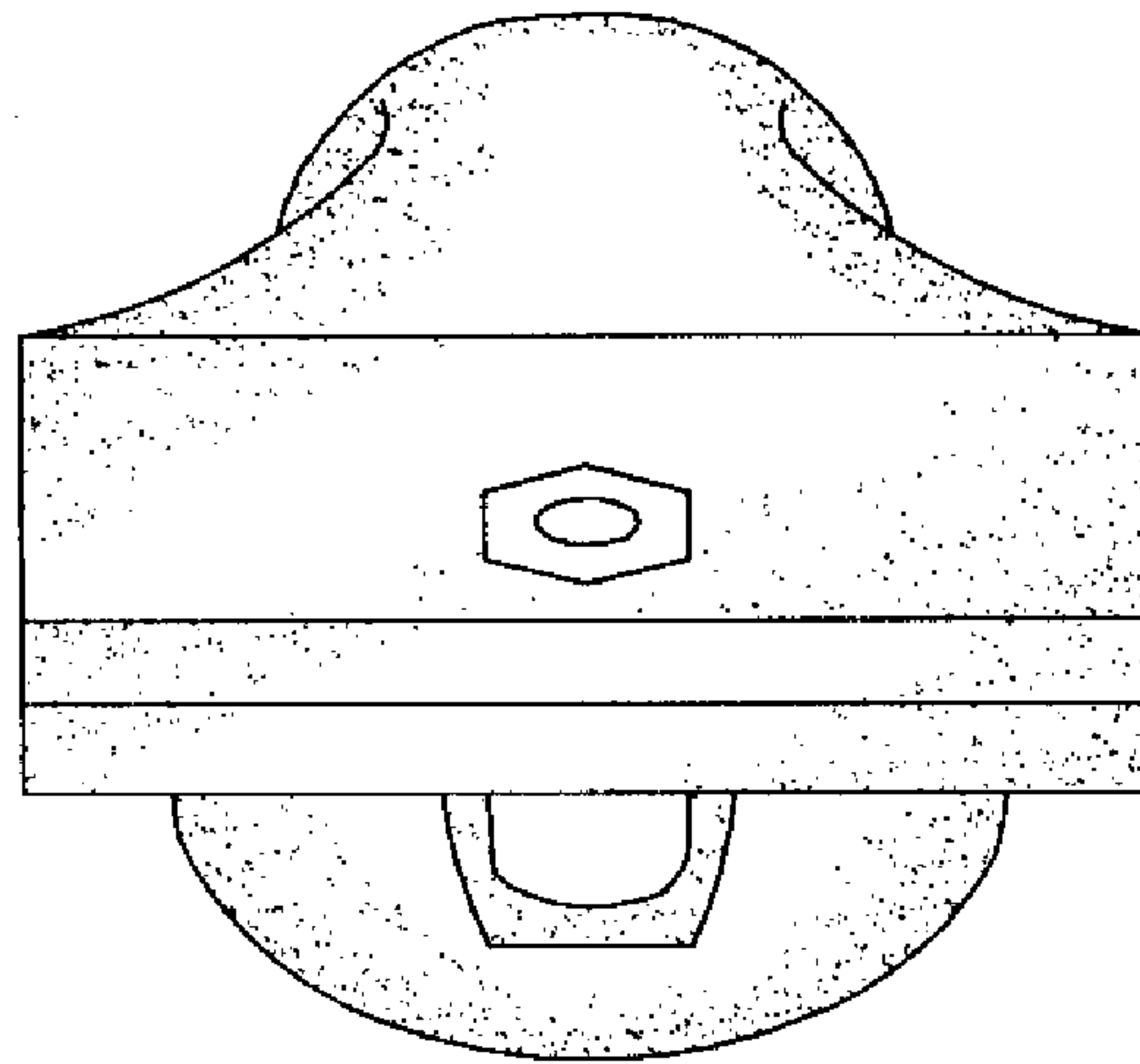

Fig. 2

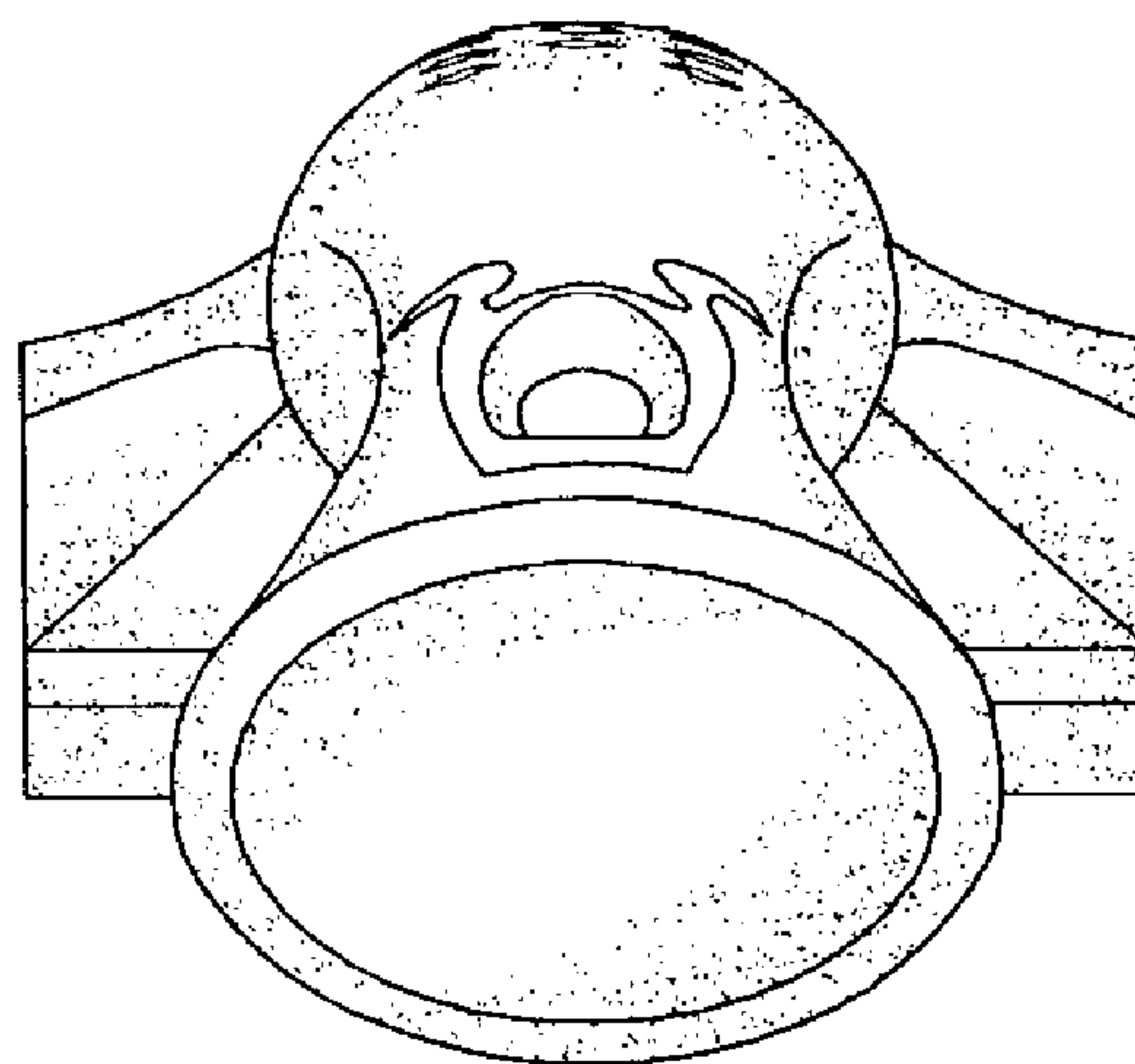

Fig. 3



Fig. 4

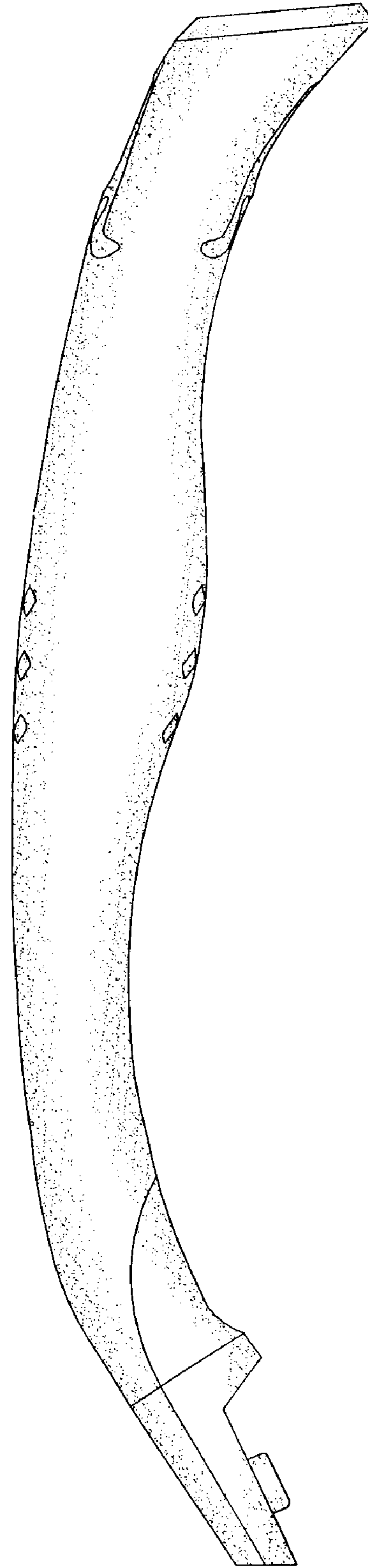

Fig. 5

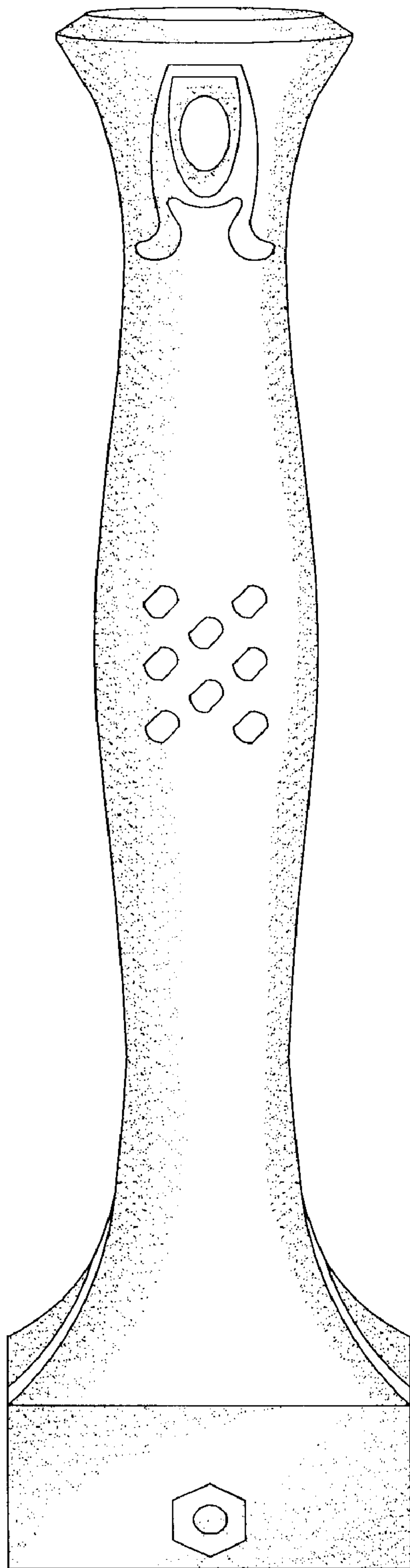

Fig. 6

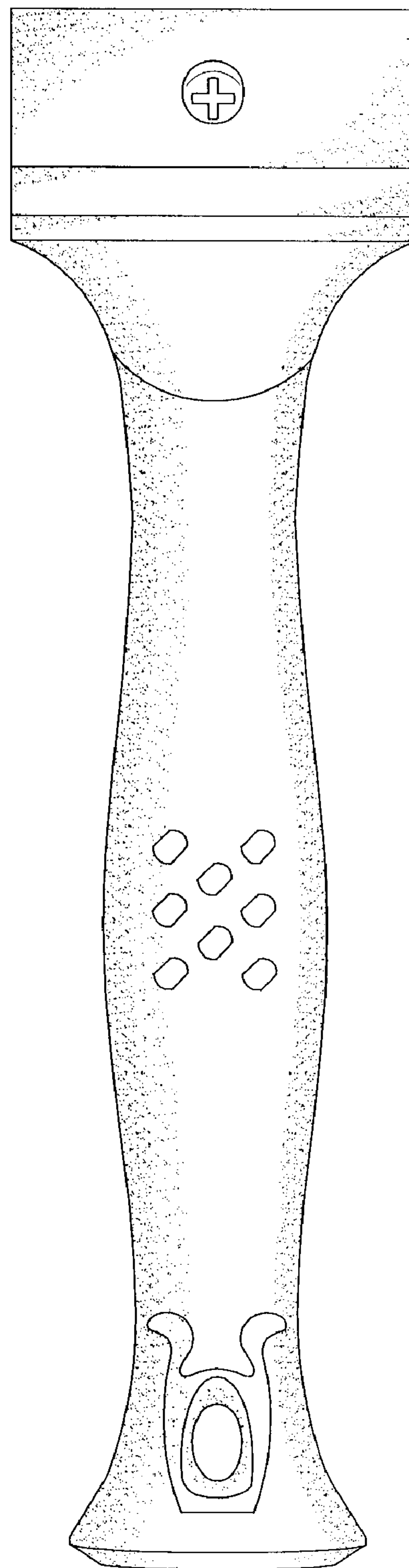

Fig. 7

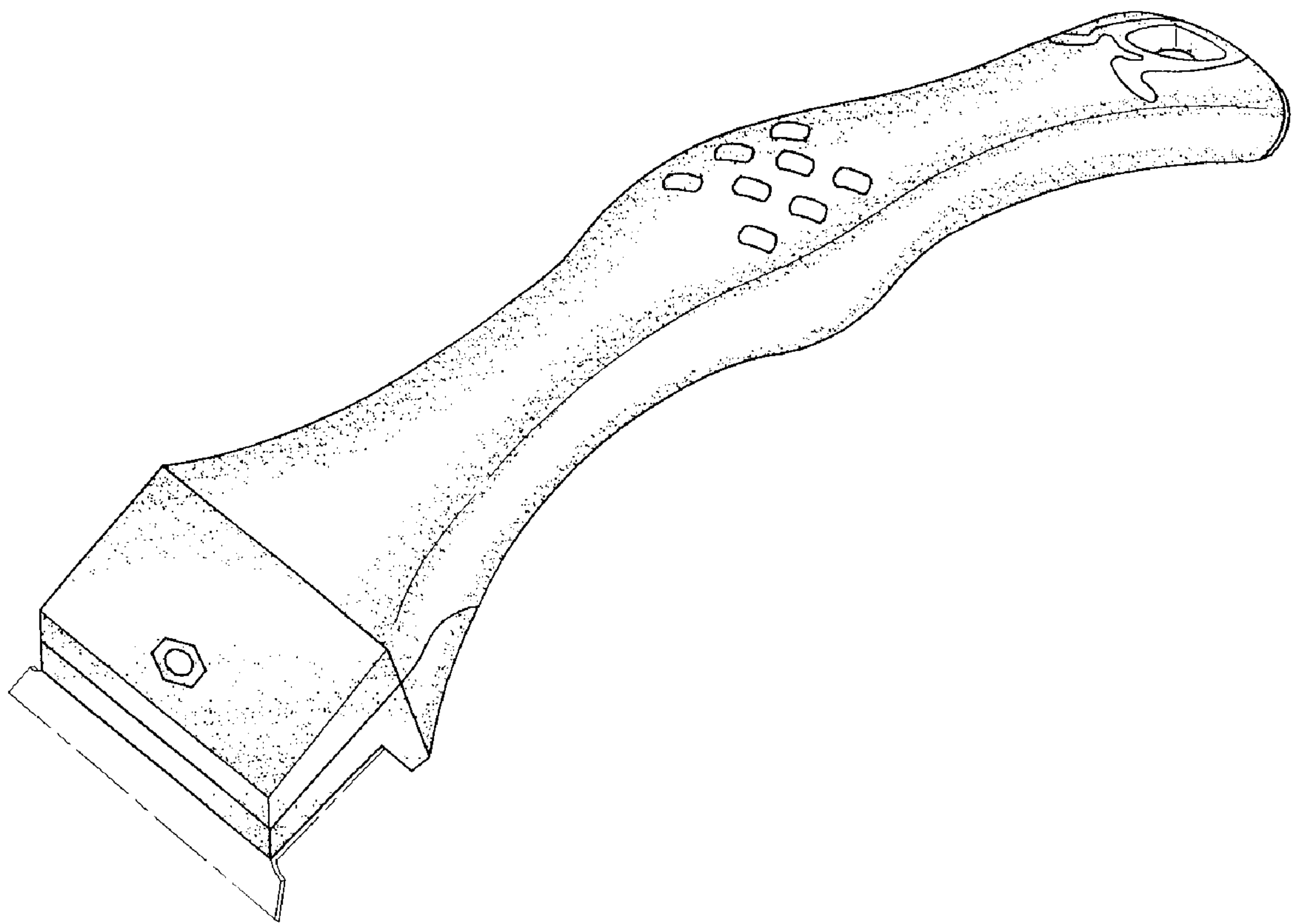

Fig. 8