



US00D517392S

(12) **United States Design Patent**  
**Lin**

(10) **Patent No.:** **US D517,392 S**  
(45) **Date of Patent:** **\*\* Mar. 21, 2006**

(54) **HANDLE**

(76) **Inventor:** **Yu-Chen Lin**, 235 Chung-Ho Box  
8-24, Taipei (TW)

(\*\*) **Term:** **14 Years**

(21) **Appl. No.:** **29/203,715**

(22) **Filed:** **Apr. 20, 2004**

(51) **LOC (8) Cl.** ..... **08-01**

(52) **U.S. Cl.** ..... **D8/107; D8/300**

(58) **Field of Classification Search** ..... D8/107,  
D8/300, 307, 313, 315-316, 321-322, 338,  
D8/343, 350, DIG. 7; D3/312, 313; 16/110.1,  
16/442, 444, DIG. 12, 404, 430; 81/489;  
292/247; 15/120.2, 143.1; D24/133  
See application file for complete search history.

(56) **References Cited**

**U.S. PATENT DOCUMENTS**

D426,569 S \* 6/2000 Franks et al. .... D18/15  
D450,995 S \* 11/2001 Henry ..... D8/107

D469,327 S \* 1/2003 Chen ..... D8/107  
D483,243 S \* 12/2003 Chen ..... D8/107  
D500,925 S \* 1/2005 Hay et al. .... D4/138  
D505,791 S \* 6/2005 Chang ..... D4/138

\* cited by examiner

*Primary Examiner*—Stella Reid  
*Assistant Examiner*—Jean E. McCormick

(57) **CLAIM**

The ornamental design for a handle, as shown and described.

**DESCRIPTION**

FIG. 1 is a perspective view of a handle showing my new design.

FIG. 2 is a front elevational view thereof;

FIG. 3 is a rear elevational view thereof;

FIG. 4 is a left side view thereof;

FIG. 5 is a right side view thereof;

FIG. 6 is a top plan view thereof; and,

FIG. 7 is a bottom plan view thereof.

**1 Claim, 7 Drawing Sheets**

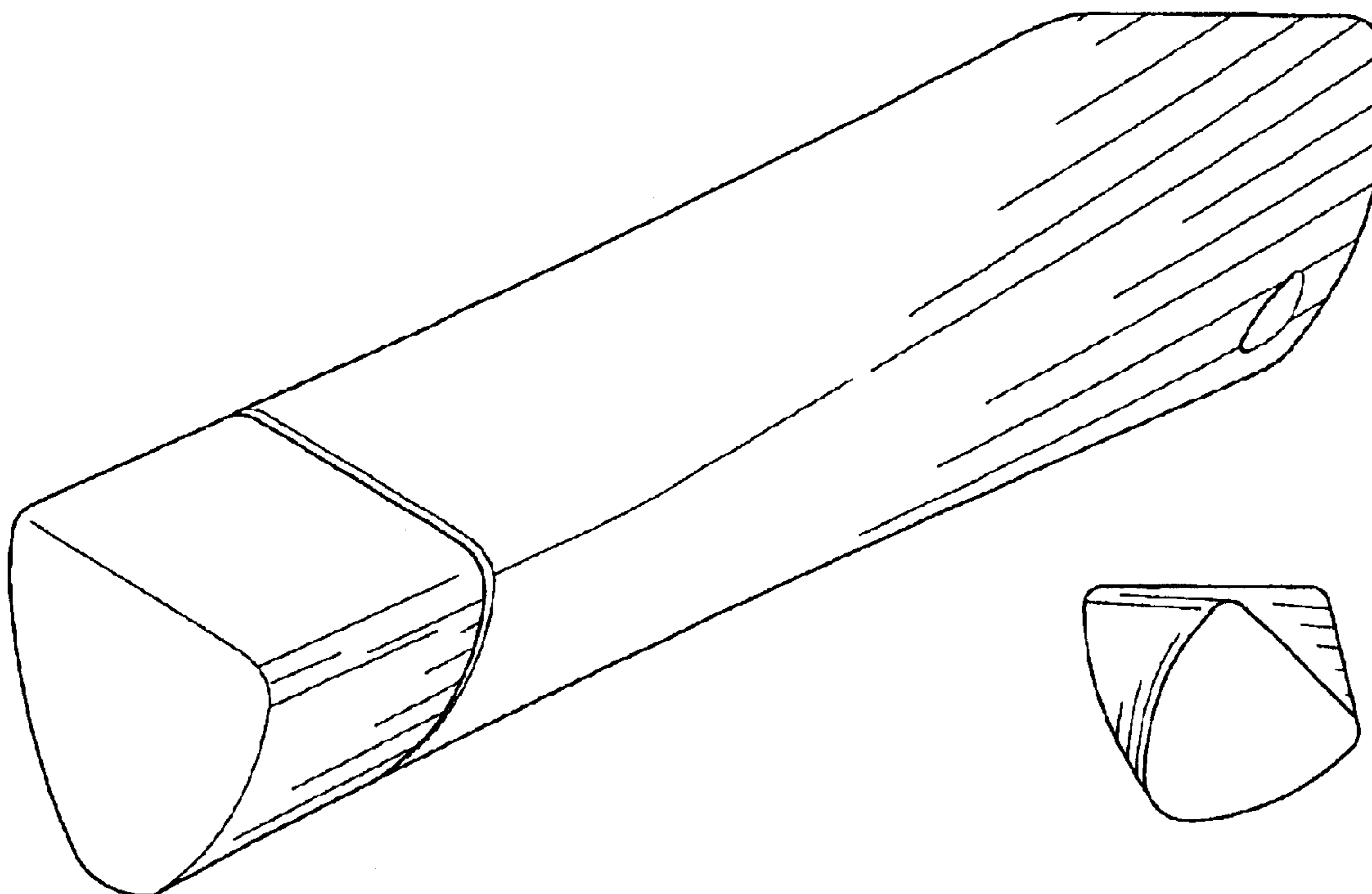

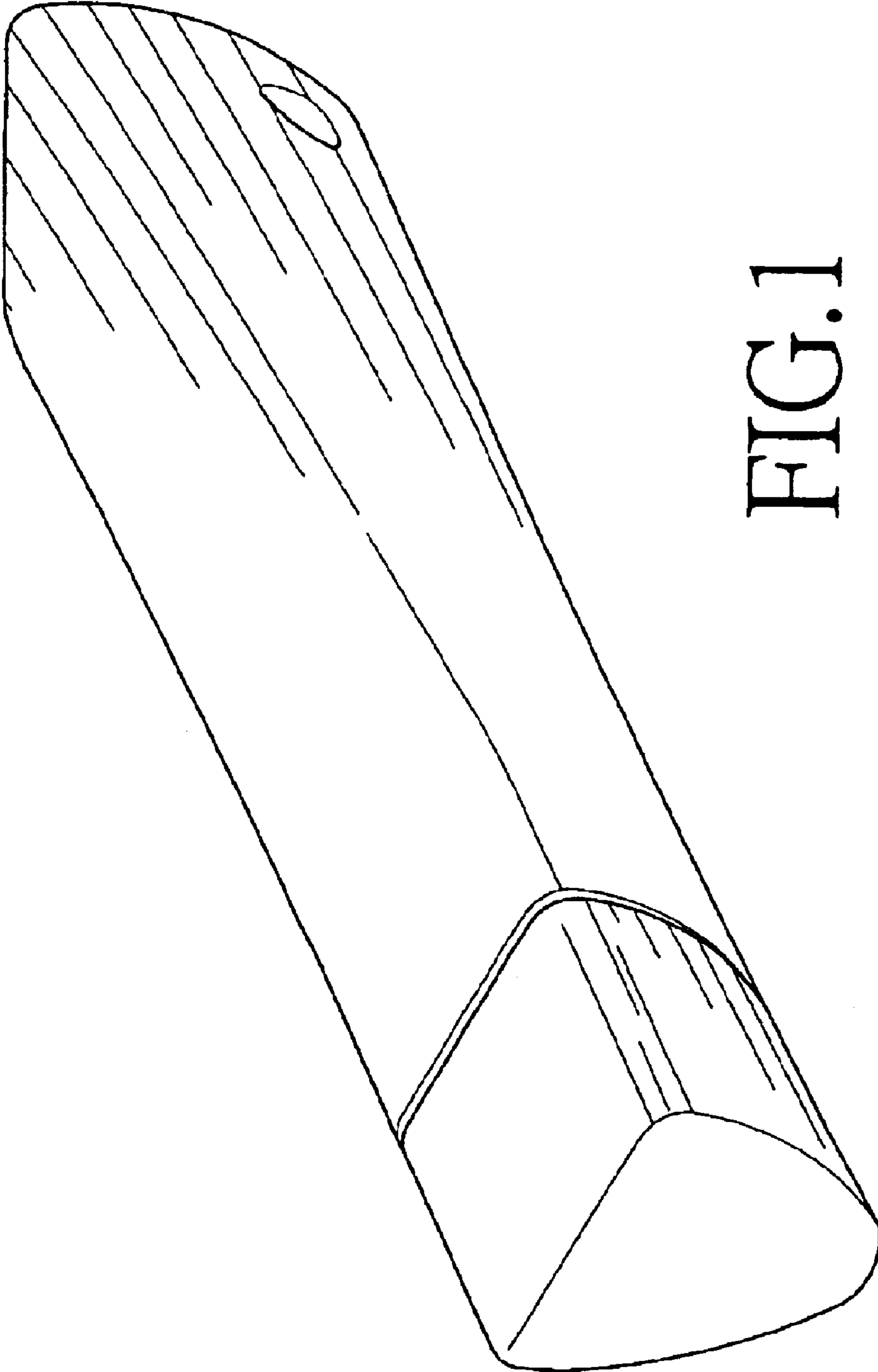

FIG. 1

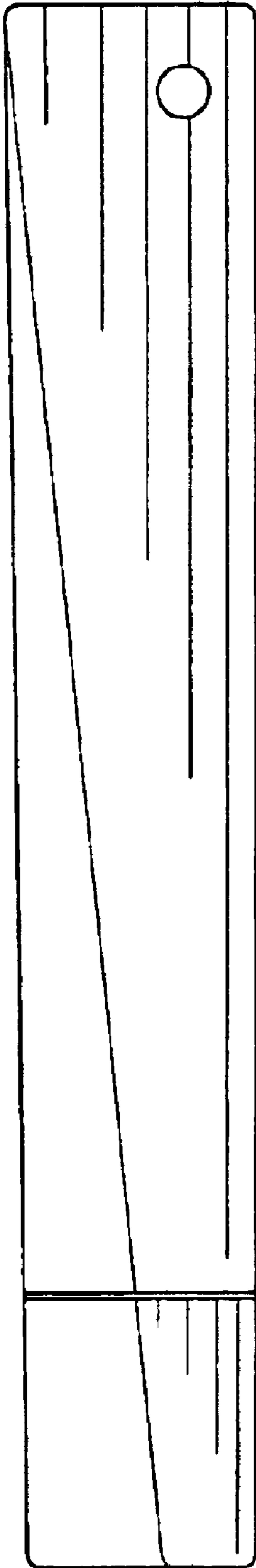

FIG. 2

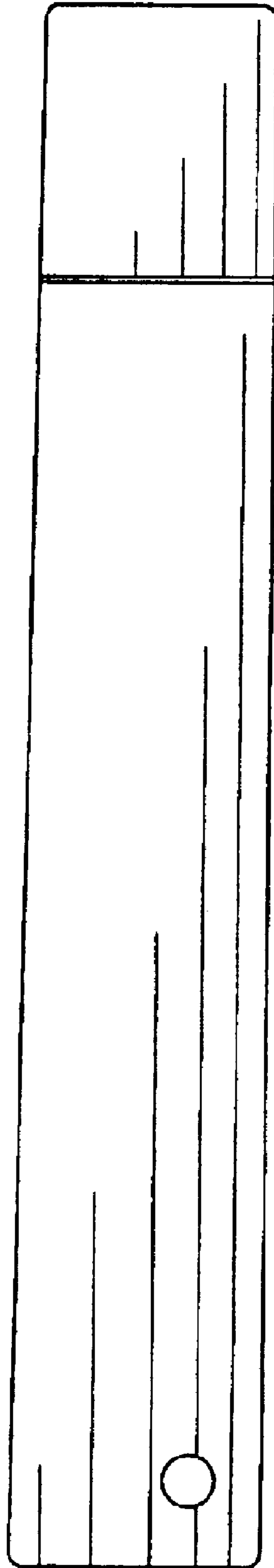

FIG. 3

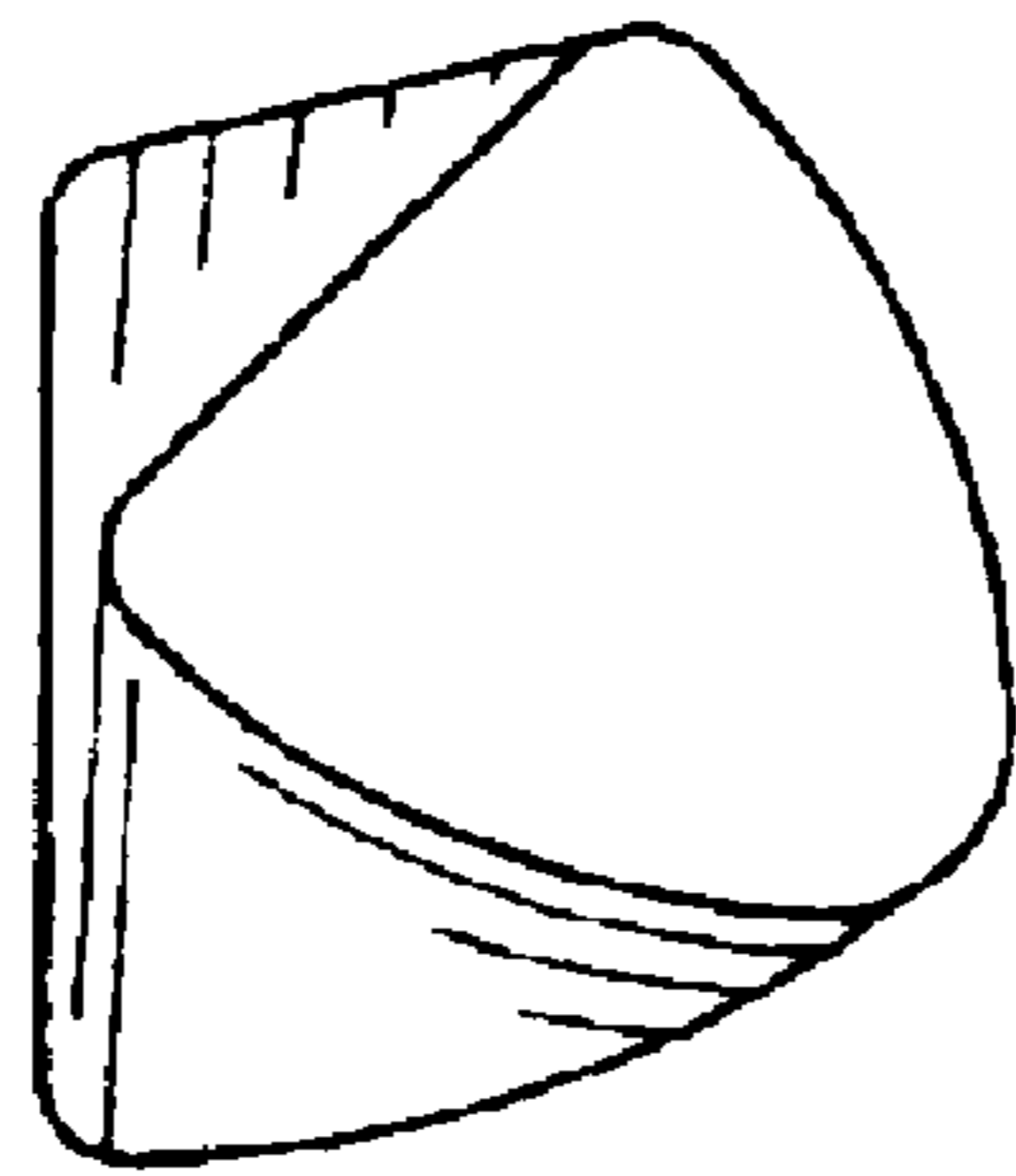

FIG.4

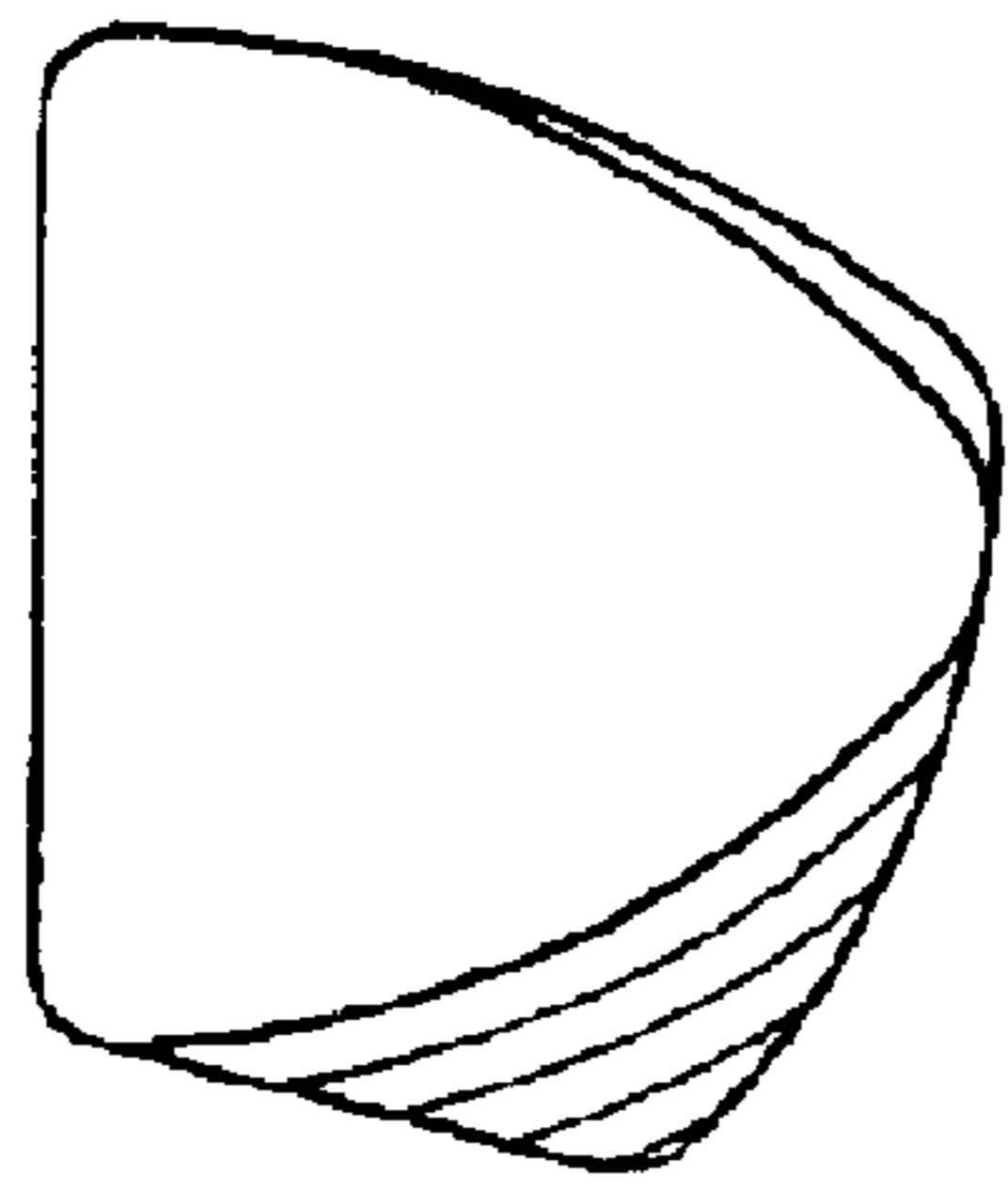

FIG. 5

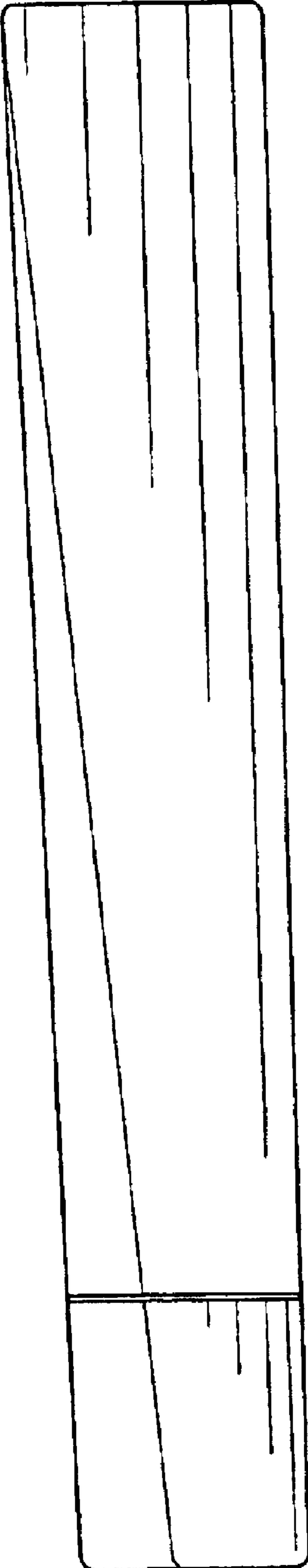

FIG. 6

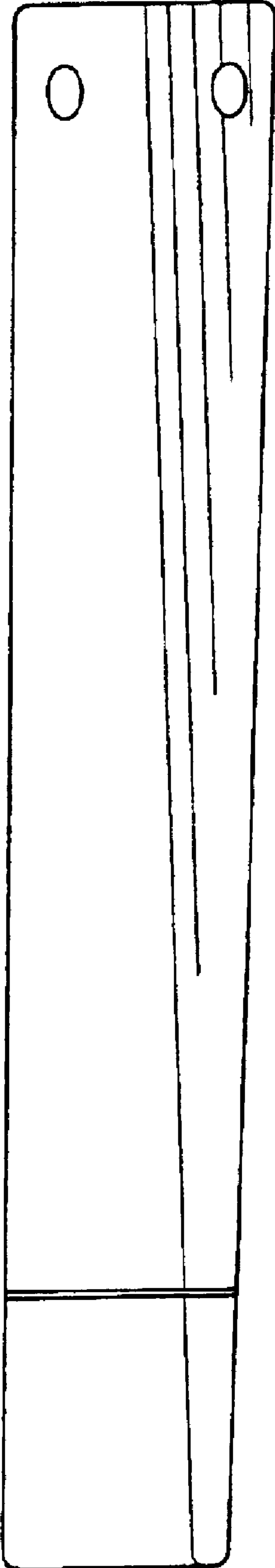

FIG. 7