



US00D517363S

(12) **United States Design Patent** (10) **Patent No.:** **US D517,363 S**
Goto (45) **Date of Patent:** **** Mar. 21, 2006**

(54) **CASE FOR DISC CARTRIDGES**

(75) Inventor: **Teiyu Goto**, Tokyo (JP)

(73) Assignee: **Sony Computer Entertainment Inc.**,
Tokyo (JP)

(**) Term: **14 Years**

(21) Appl. No.: **29/213,847**

(22) Filed: **Sep. 24, 2004**

(30) **Foreign Application Priority Data**

Aug. 6, 2004 (JP) D2004-023774

(51) **LOC (8) Cl.** **06-04**

(52) **U.S. Cl.** **D6/629; D6/407; D6/632;**
D6/635

(58) **Field of Classification Search** D3/218,
D3/270; D6/407, 626-635; 206/18, 307.1,
206/308.1, 308.2, 308.3, 309, 310, 311, 312,
206/313, 445, 749; 312/9.1, 902, 9.9, 9.48,
312/9.55, 9.64, 9.47, 9.53, 328

See application file for complete search history.

(56) **References Cited**

U.S. PATENT DOCUMENTS

D271,726 S	*	12/1983	Drake	D6/631
D324,337 S	*	3/1992	Brady	D6/634
5,290,118 A	*	3/1994	Ozeki	402/79
D378,333 S		3/1997	Anderson		
D411,071 S	*	6/1999	Cerda-Vicedo	D6/632
D433,461 S	*	11/2000	Goto	D21/330
D452,105 S	*	12/2001	Chan	D6/635
D455,312 S	*	4/2002	Myszka et al.	D6/629
D455,595 S	*	4/2002	Ikeda et al.	D6/632
D470,707 S	*	2/2003	Lopez Mas	D6/634
D474,935 S		5/2003	Goto		
D495,551 S	*	9/2004	Goto	D6/631
D501,209 S	*	1/2005	Goto	D14/478
D501,482 S	*	2/2005	Goto	D14/478
2005/0092628 A1	*	5/2005	Chang	206/308.1

* cited by examiner

Primary Examiner—Celia A. Murphy

(74) *Attorney, Agent, or Firm*—Rader Fishman & Grauer PLLC

(57) **CLAIM**

The ornamental design for a case for disc cartridges, as shown.

DESCRIPTION

FIG. 1 is a front elevational view of a case for disc cartridges showing my new design;

FIG. 2 is a rear elevational view thereof;

FIG. 3 is a left side elevational view thereof;

FIG. 4 is a right side elevational view thereof;

FIG. 5 is a top plan view thereof;

FIG. 6 is a bottom plan view thereof;

FIG. 7 is a front elevational view thereof;

FIG. 8 is a cross sectional view taken on line VIII—VIII of FIG. 7;

FIG. 9 is a cross-sectional view taken along line IX—IX of FIG. 7;

FIG. 10 is a cross-sectional view taken along line X—X of FIG. 7;

FIG. 11 is a cross-sectional view taken along line XI—XI of FIG. 7;

FIG. 12 is a cross-sectional view taken along line XII—XII'—XII"—XII'" of FIG. 7;

FIG. 13 is a cross-sectional view taken along line XIII—XIII'—XIII"—XIII'" of FIG. 7;

FIG. 14 is a cross-sectional view taken along line XIV—XIV'—XIV"—XIV'"—XIV'"'"—XIV'"'"'" of FIG. 7;

FIG. 15 is an enlarged view taken on lines XV—XV and XV'—XV' of FIG. 7;

FIG. 16 is a front elevational view of the case for disc cartridges as seen in the closed position;

FIG. 17 is a right side elevational view of FIG. 16;

FIG. 18 is a top plan view of FIG. 18; and,

FIG. 19 is a cross-sectional view taken along line XIX—XIX of FIG. 16.

1 Claim, 10 Drawing Sheets

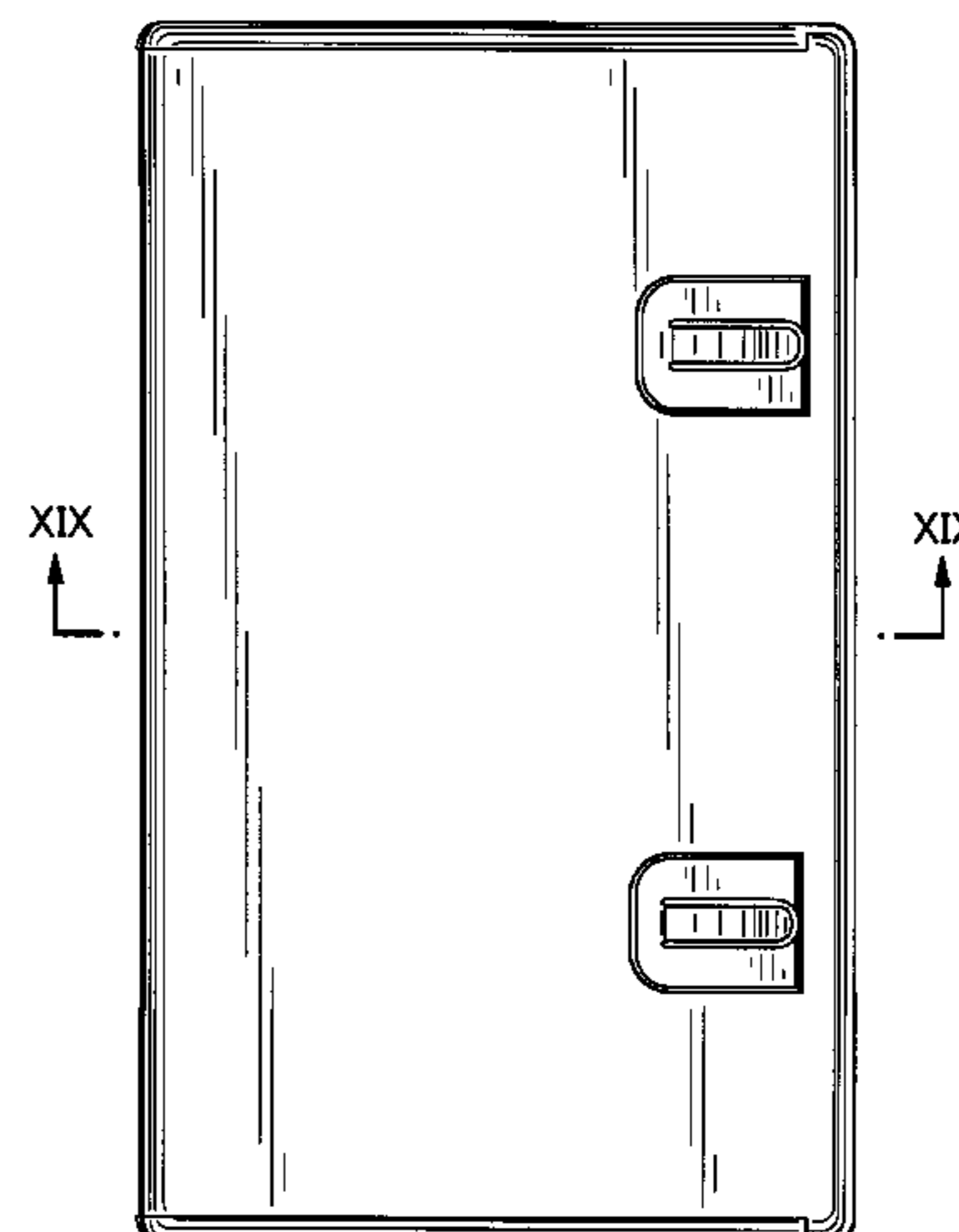
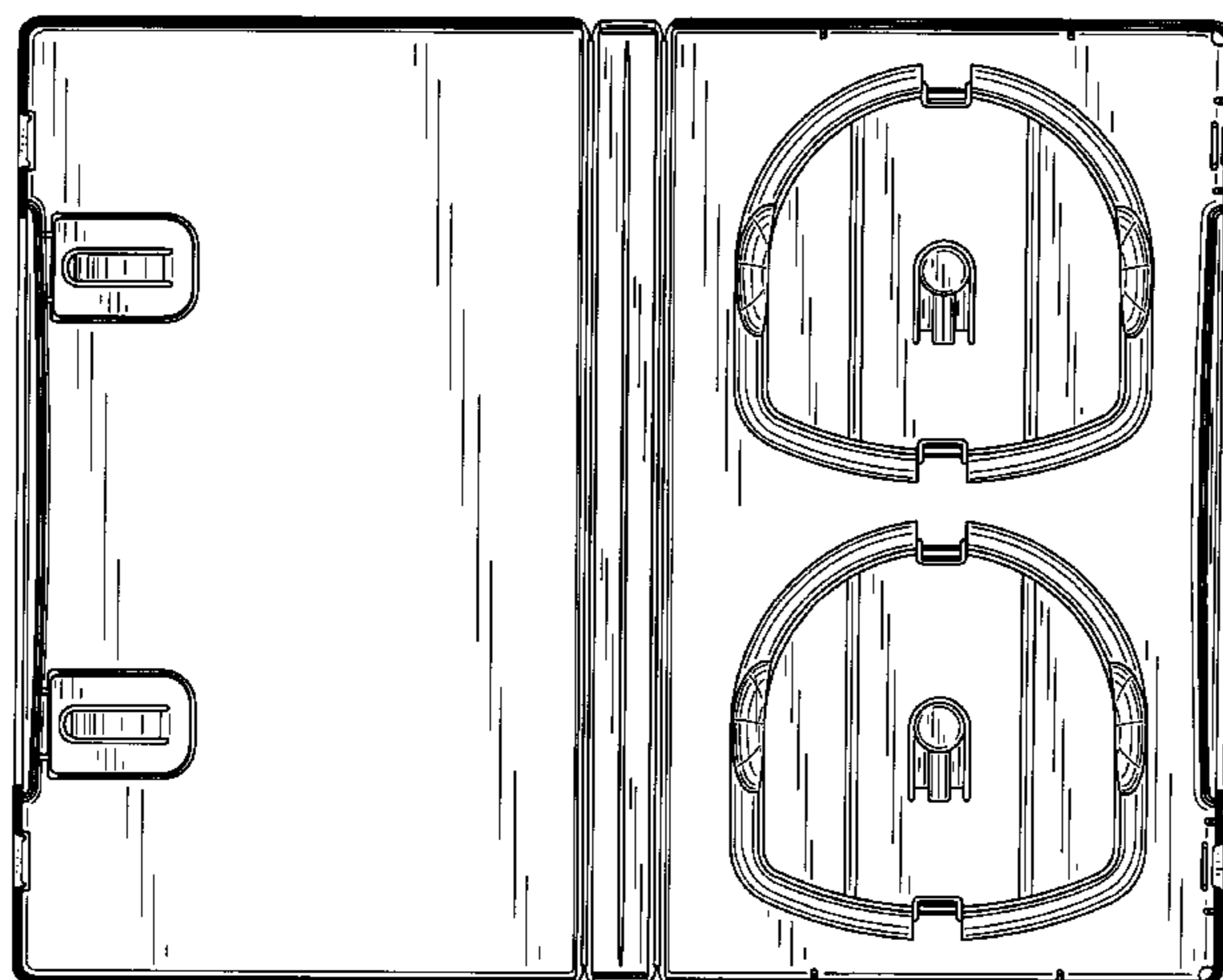

FIG.1

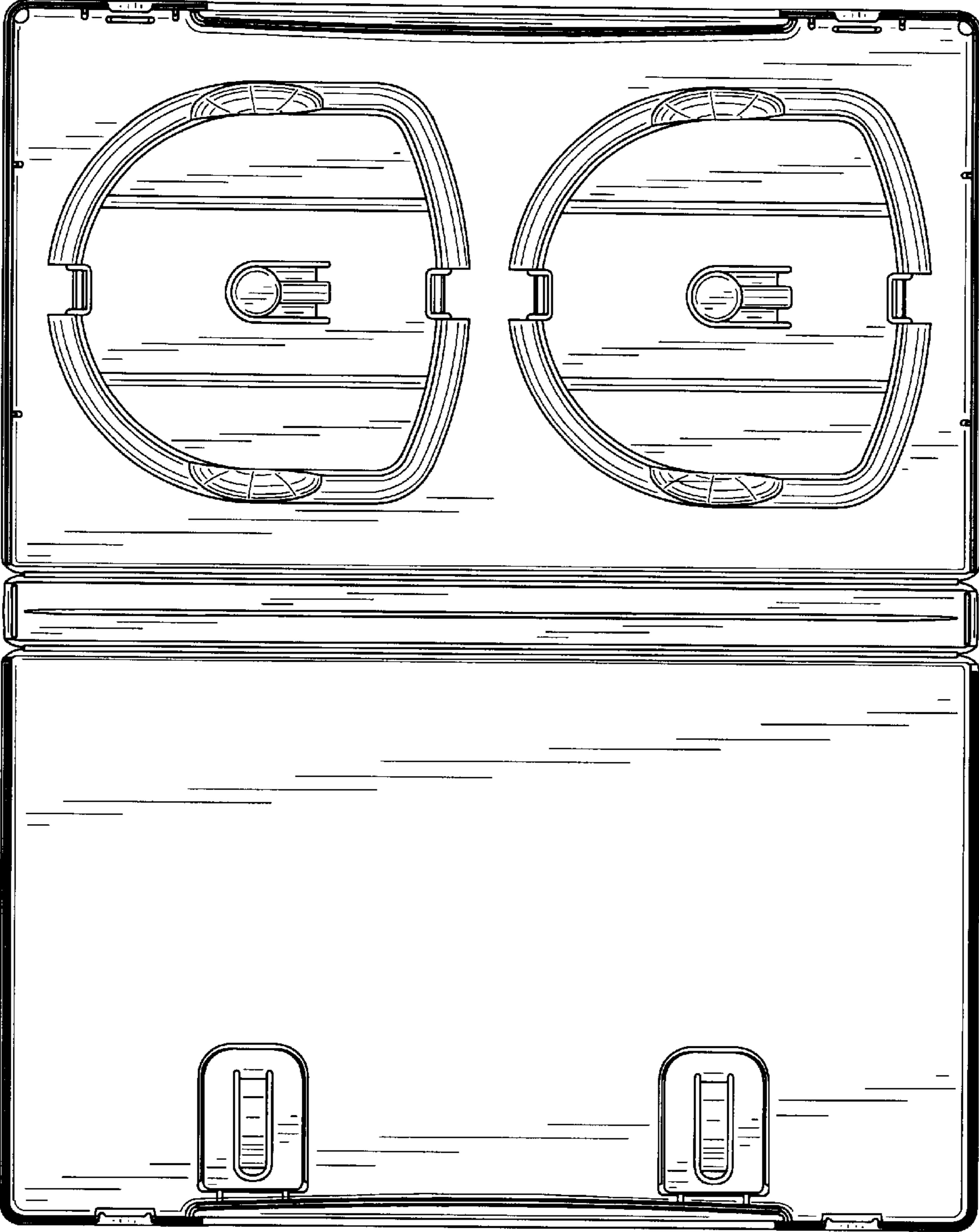

FIG.2

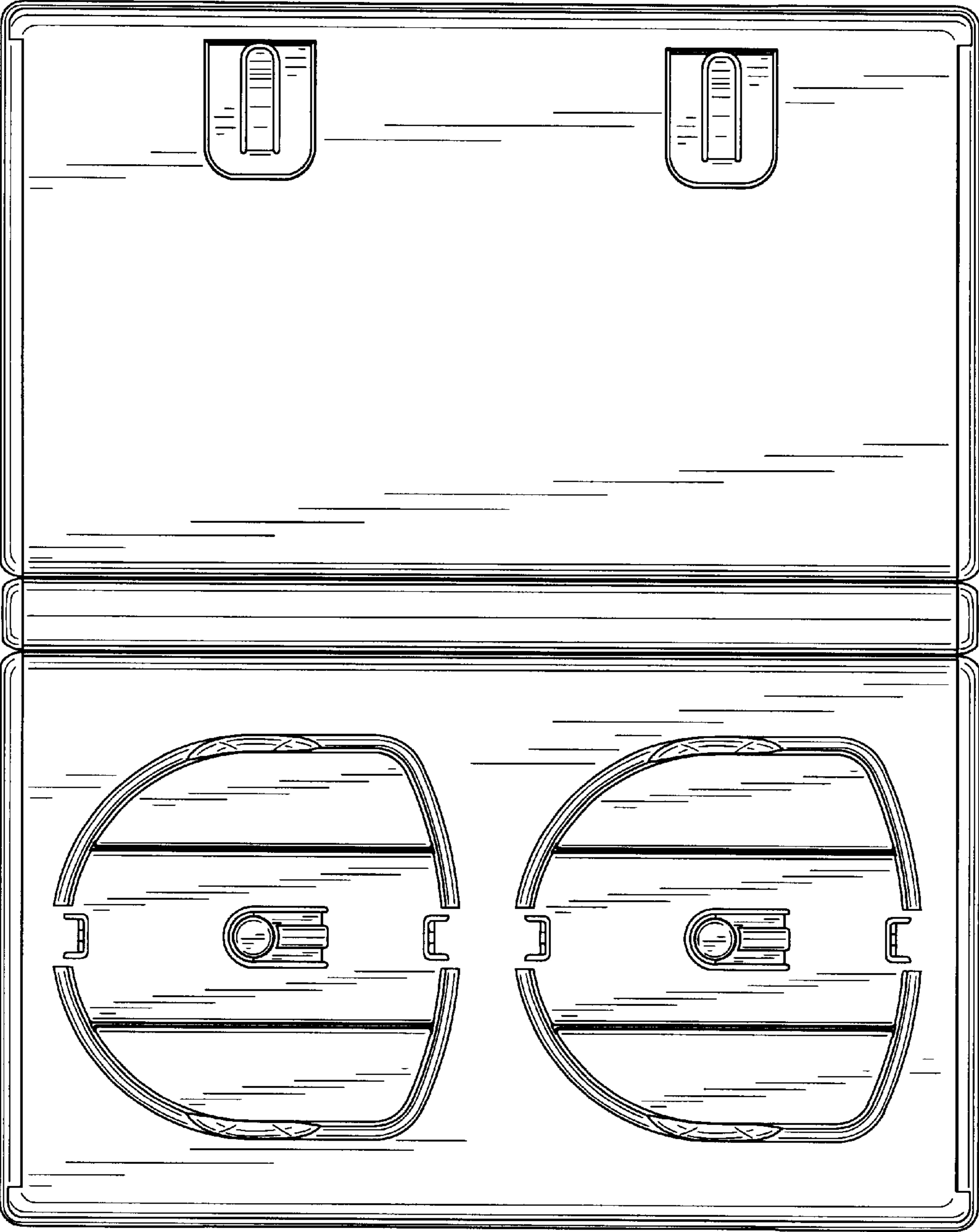

FIG.3

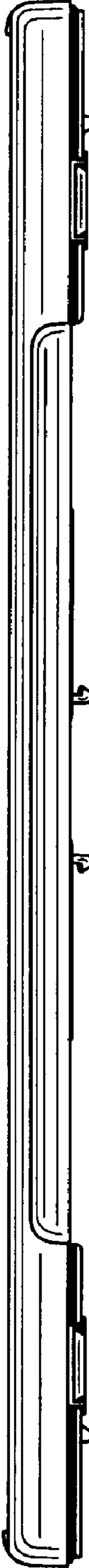

FIG.4



FIG.5



FIG.6



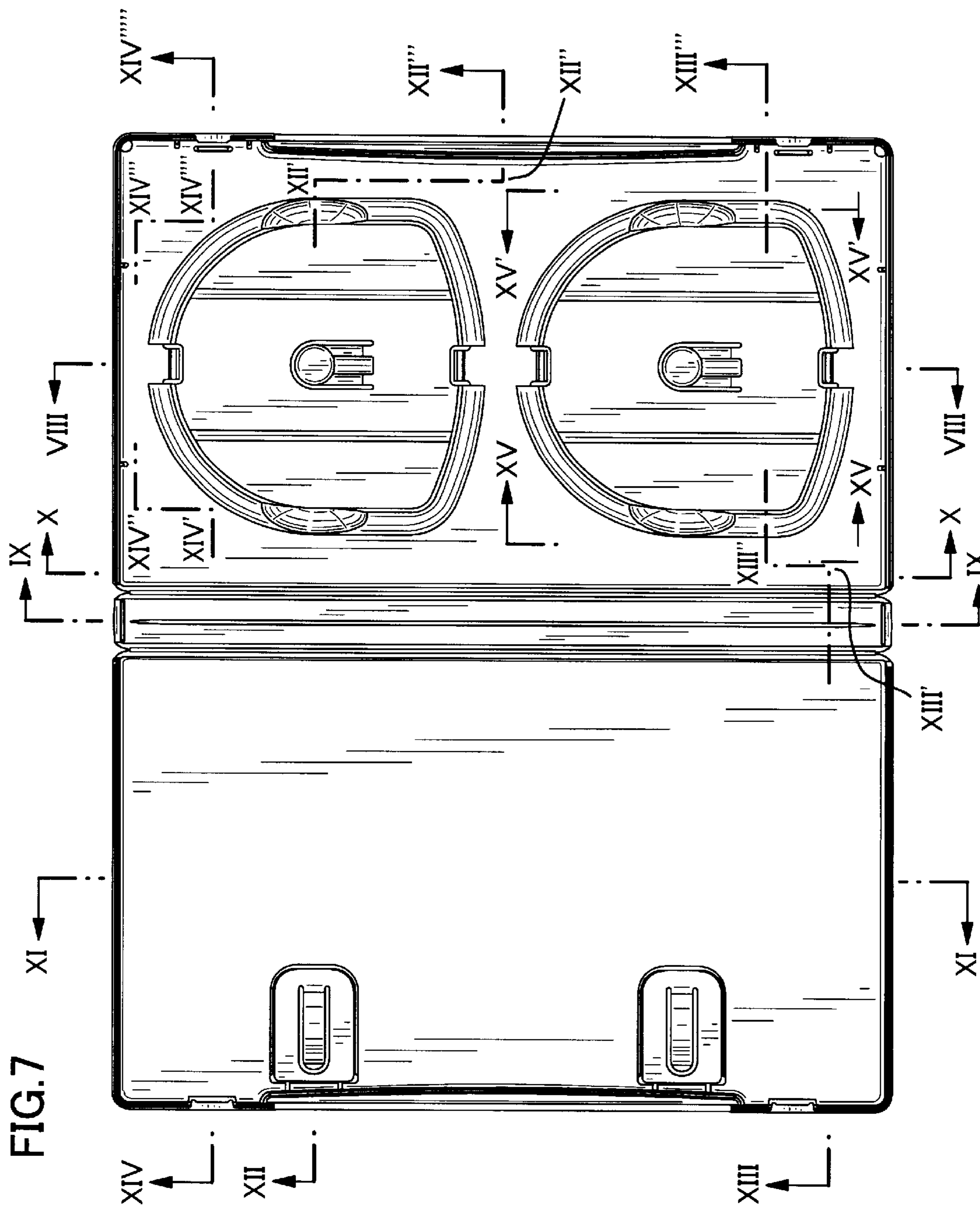

FIG.8

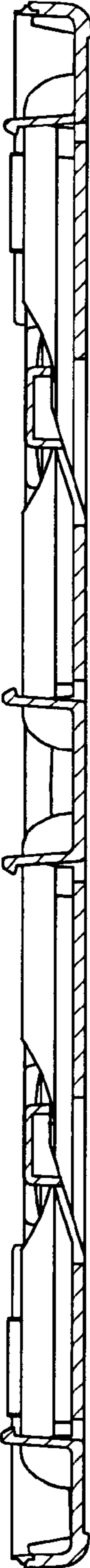

FIG.9



FIG. 10

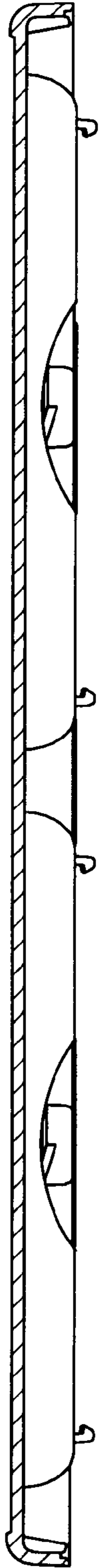

FIG. 11

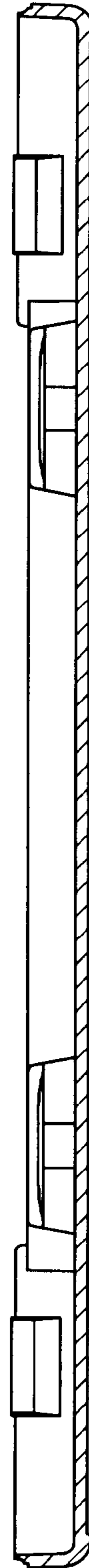

FIG.12

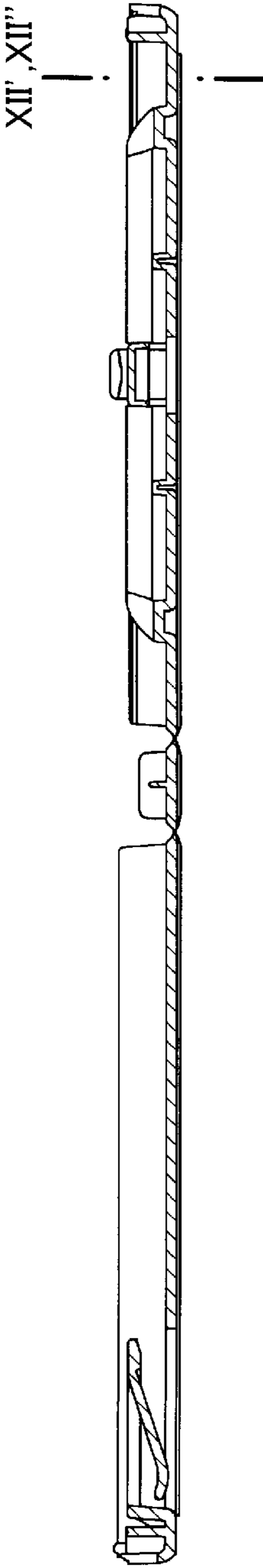

FIG.13

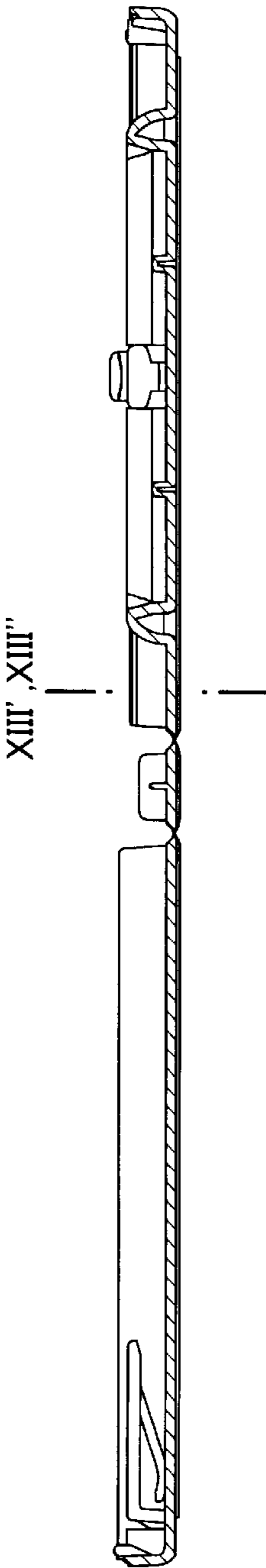

FIG.14

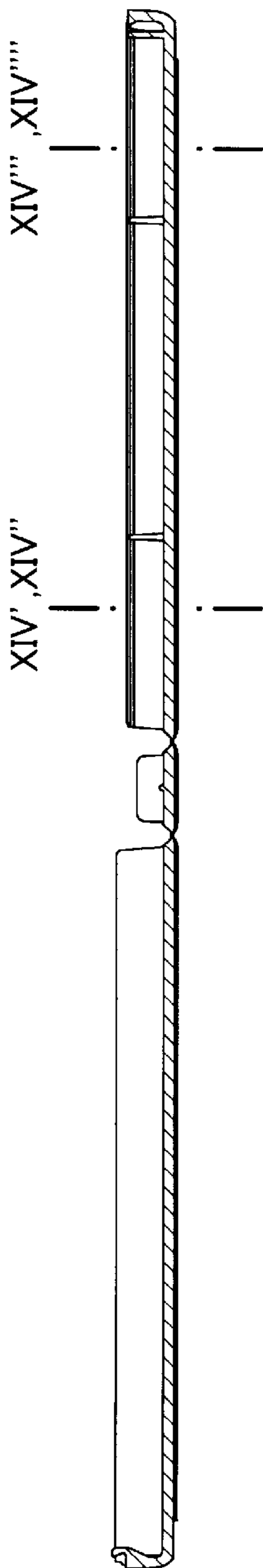

FIG.15

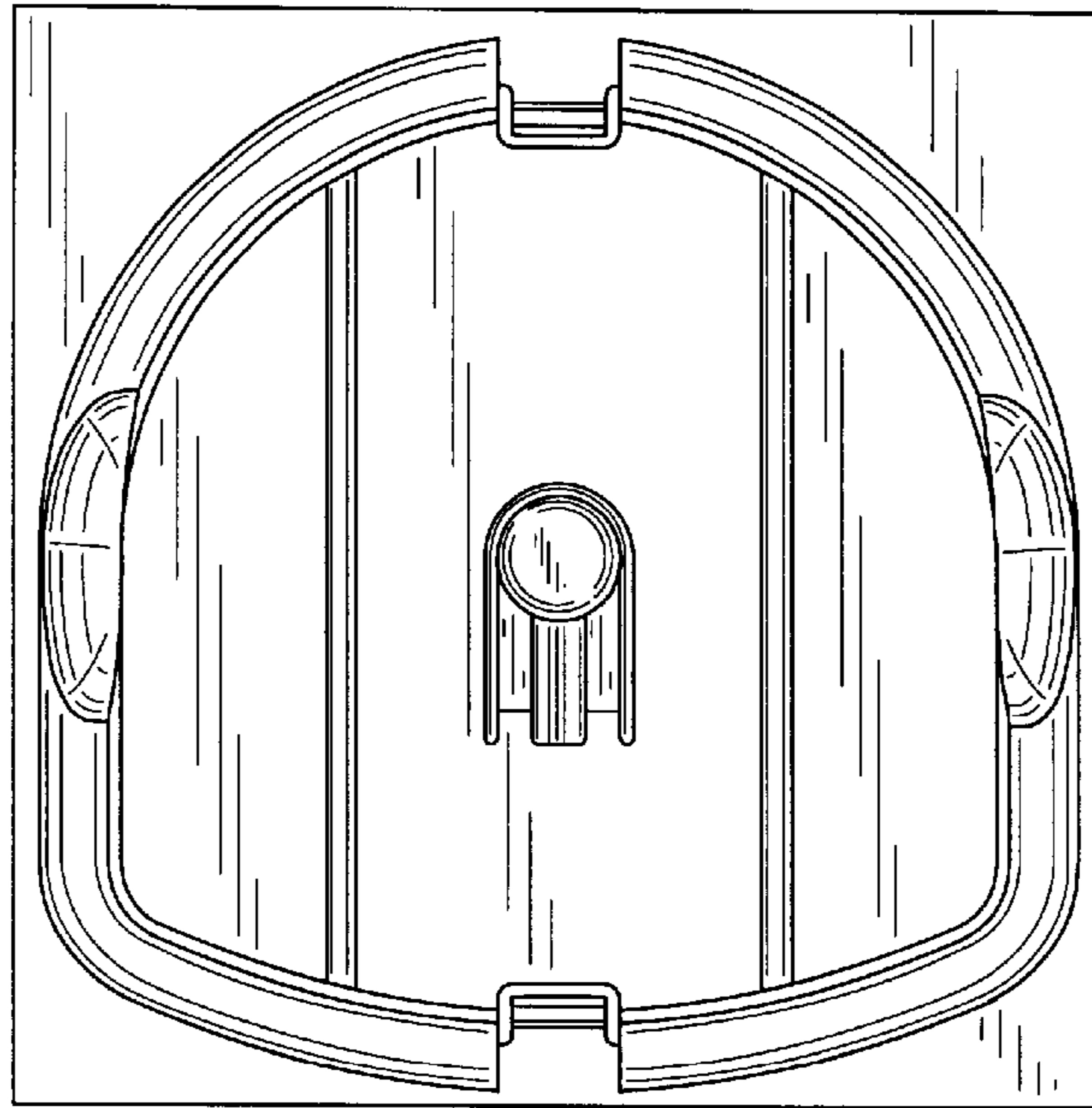

FIG.16

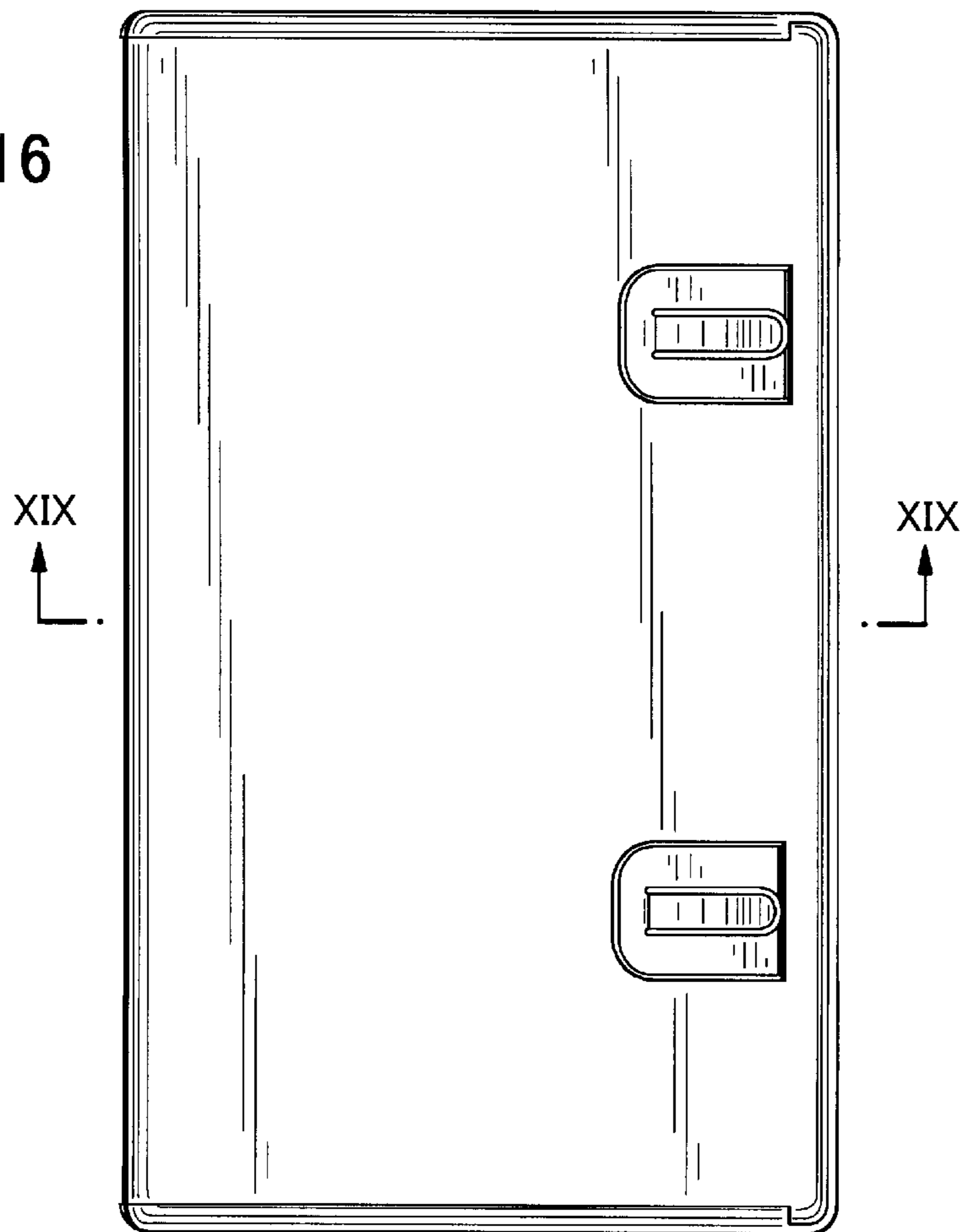

FIG.17

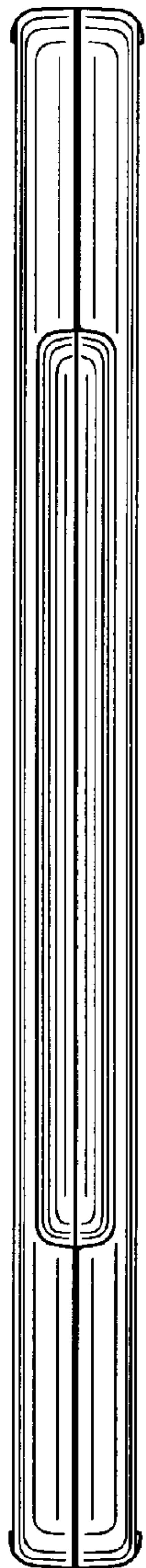

FIG.18

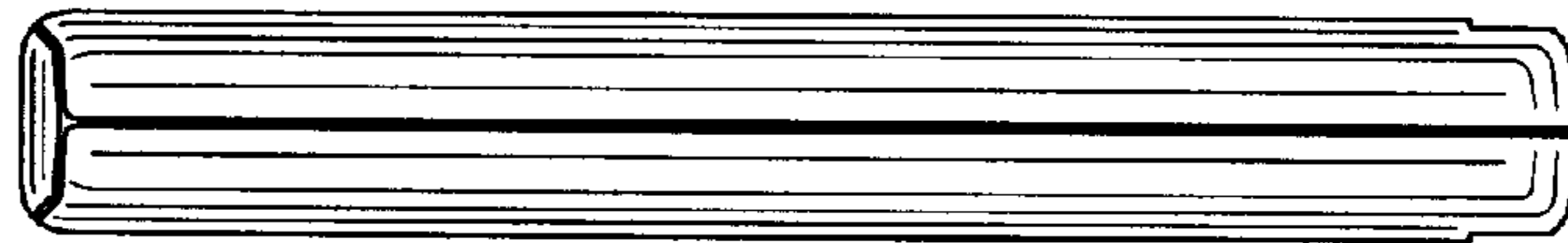

FIG.19

