



US00D517256S

(12) **United States Design Patent**
Kim

(10) **Patent No.:** **US D517,256 S**
(45) **Date of Patent:** **** Mar. 14, 2006**

(54) **WASHING MACHINE**

(75) **Inventor:** **Hee Jung Kim**, 7-305 Asia
Saeonsuchon Apt., 86 Jamsil-dong,
Songpa-gu, Seoul 138-220 (KR)

(73) **Assignees:** **Kyungwon Enterprise Co., Ltd.**, Seoul
(KR); **Hee Jung Kim**, Seoul (KR)

(**) **Term:** **14 Years**

(21) **Appl. No.:** **29/226,491**

(22) **Filed:** **Mar. 29, 2005**

(30) **Foreign Application Priority Data**

Sep. 30, 2004 (KR) 30-2004-0030075

(51) **LOC (8) Cl.** **15-05**

(52) **U.S. Cl.** **D32/6**

(58) **Field of Classification Search** D32/5,
D32/6, 8, 10, 12, 2, 1; 68/212, 3 R, 12.26,
68/12.01, 12.12, 24; 34/58, 108, 134, 596,
34/603, 139, 601, 602

See application file for complete search history.

(56) **References Cited**

U.S. PATENT DOCUMENTS

153,921 A * 8/1874 Boldt 431/120

D340,785 S * 10/1993 Bover D32/6
D447,608 S * 9/2001 Myerscough D32/6
D450,164 S * 11/2001 Dyson et al. D32/6
D456,572 S * 4/2002 Resuello et al. D32/6
D477,898 S * 7/2003 Geyer D32/6
D496,709 S * 9/2004 Suh et al. D32/6
D502,577 S * 3/2005 Baldwin et al. D32/6

* cited by examiner

Primary Examiner—Louis S. Zarfaz

Assistant Examiner—Kathleen Sims

(74) *Attorney, Agent, or Firm*—Merchant & Gould P.C.

(57) **CLAIM**

The ornamental design for washing machine, as shown and described.

DESCRIPTION

FIG. 1 is a perspective view of an embodiment of a washing machine showing my new design;
FIG. 2 is a front view thereof;
FIG. 3 is a back view thereof;
FIG. 4 is a left side view thereof;
FIG. 5 is a right side view thereof;
FIG. 6 is a top view thereof; and,
FIG. 7 is a bottom view thereof.

1 Claim, 7 Drawing Sheets

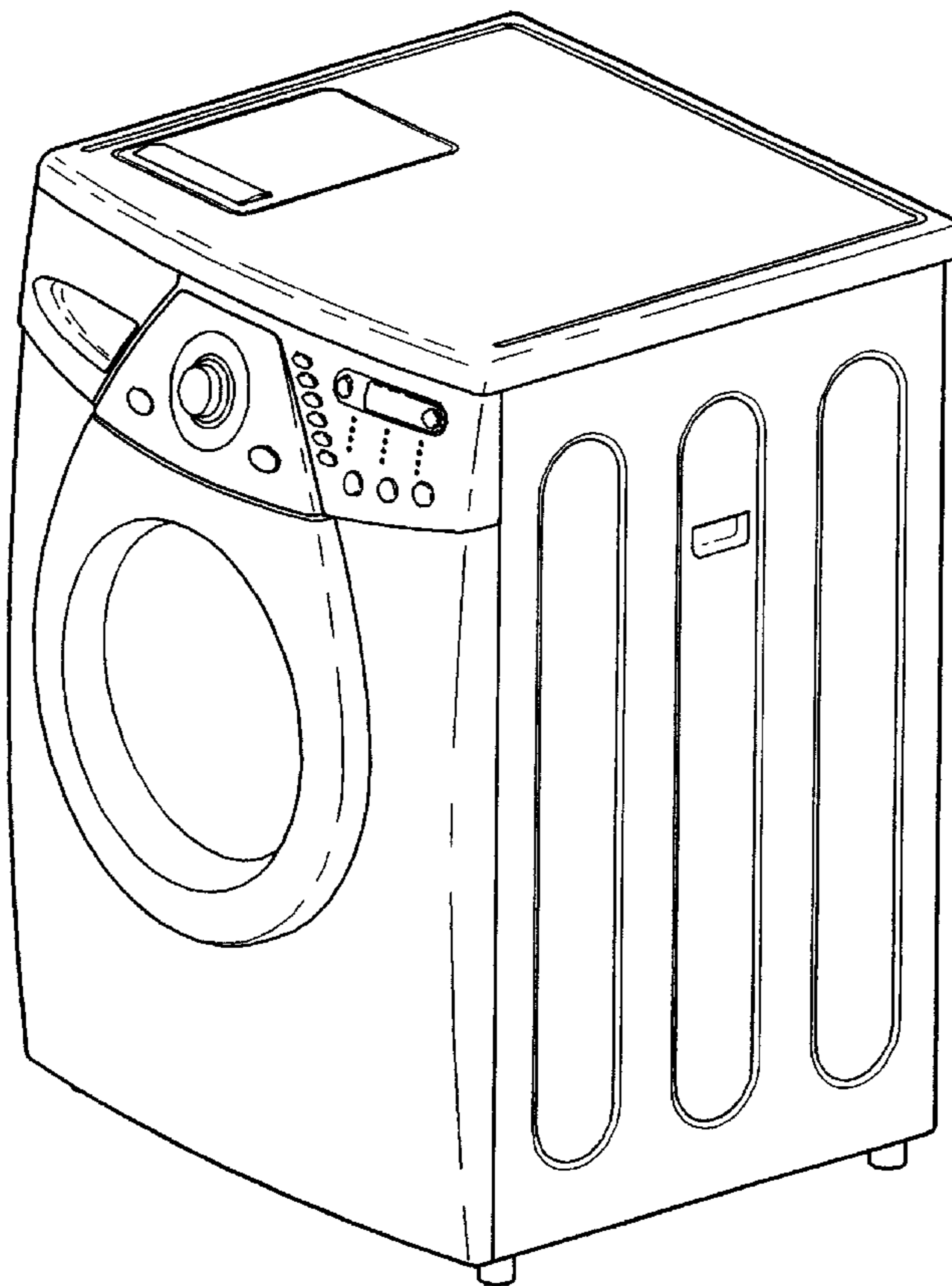

Fig.1

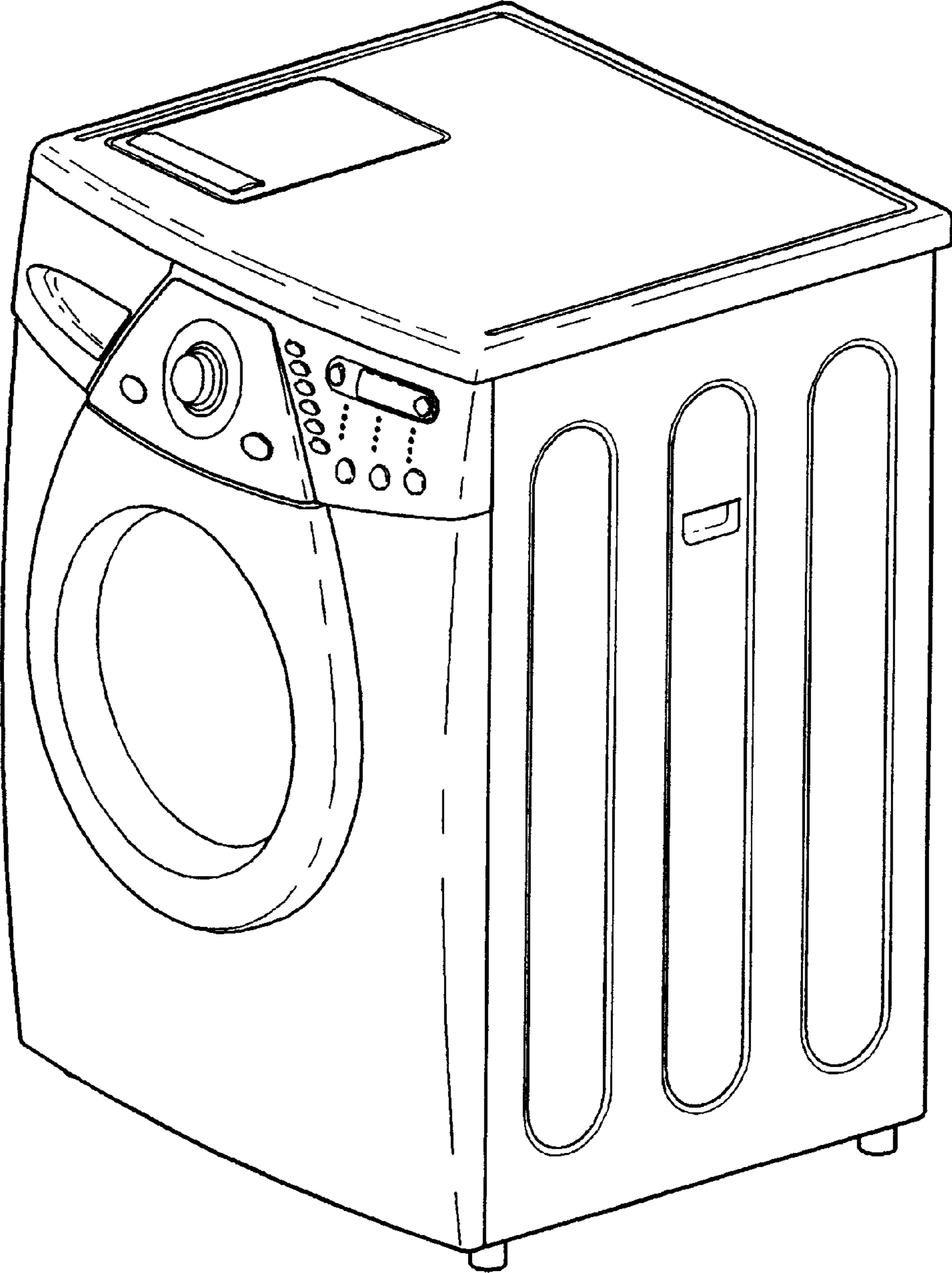

Fig.2

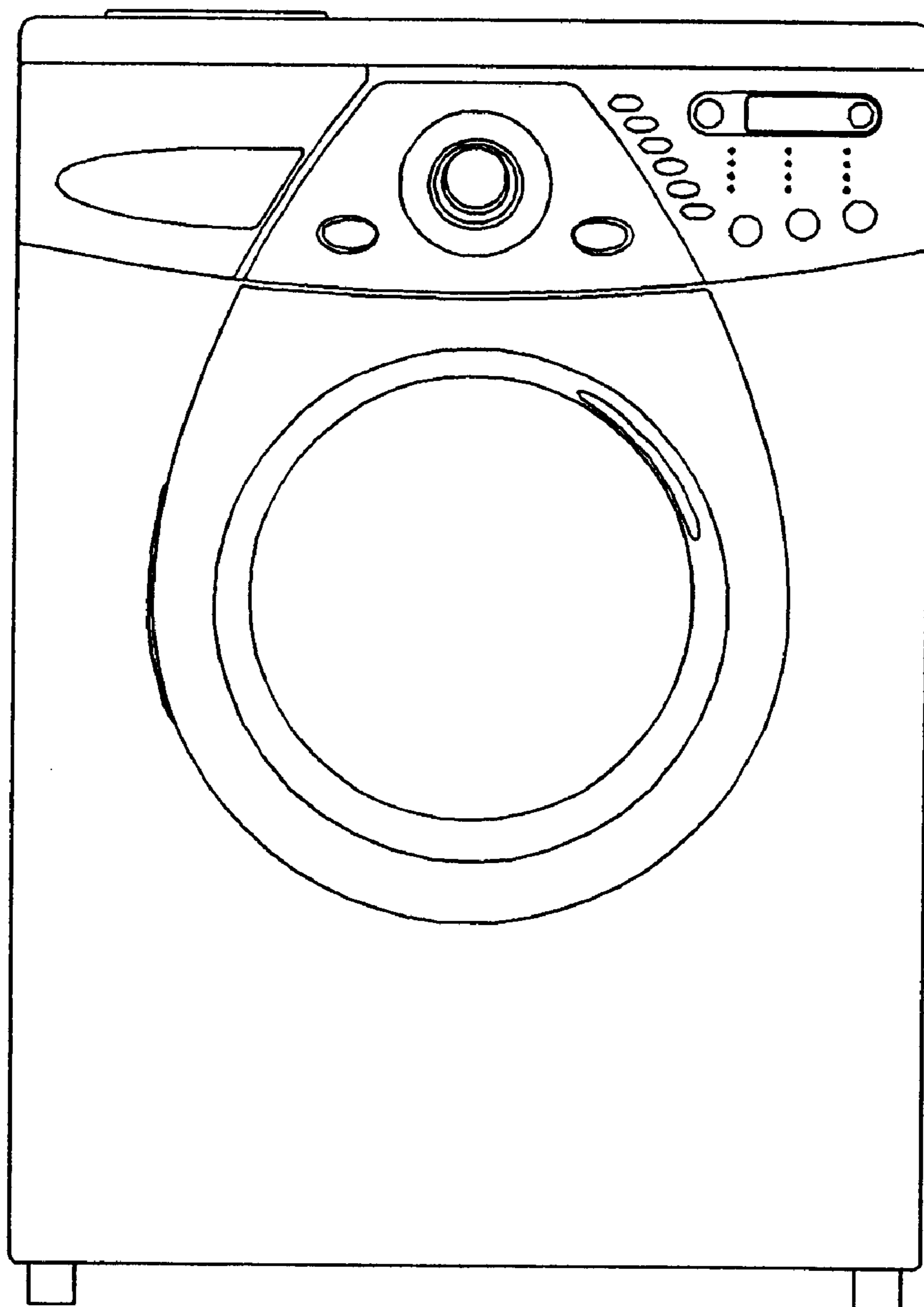

Fig.3

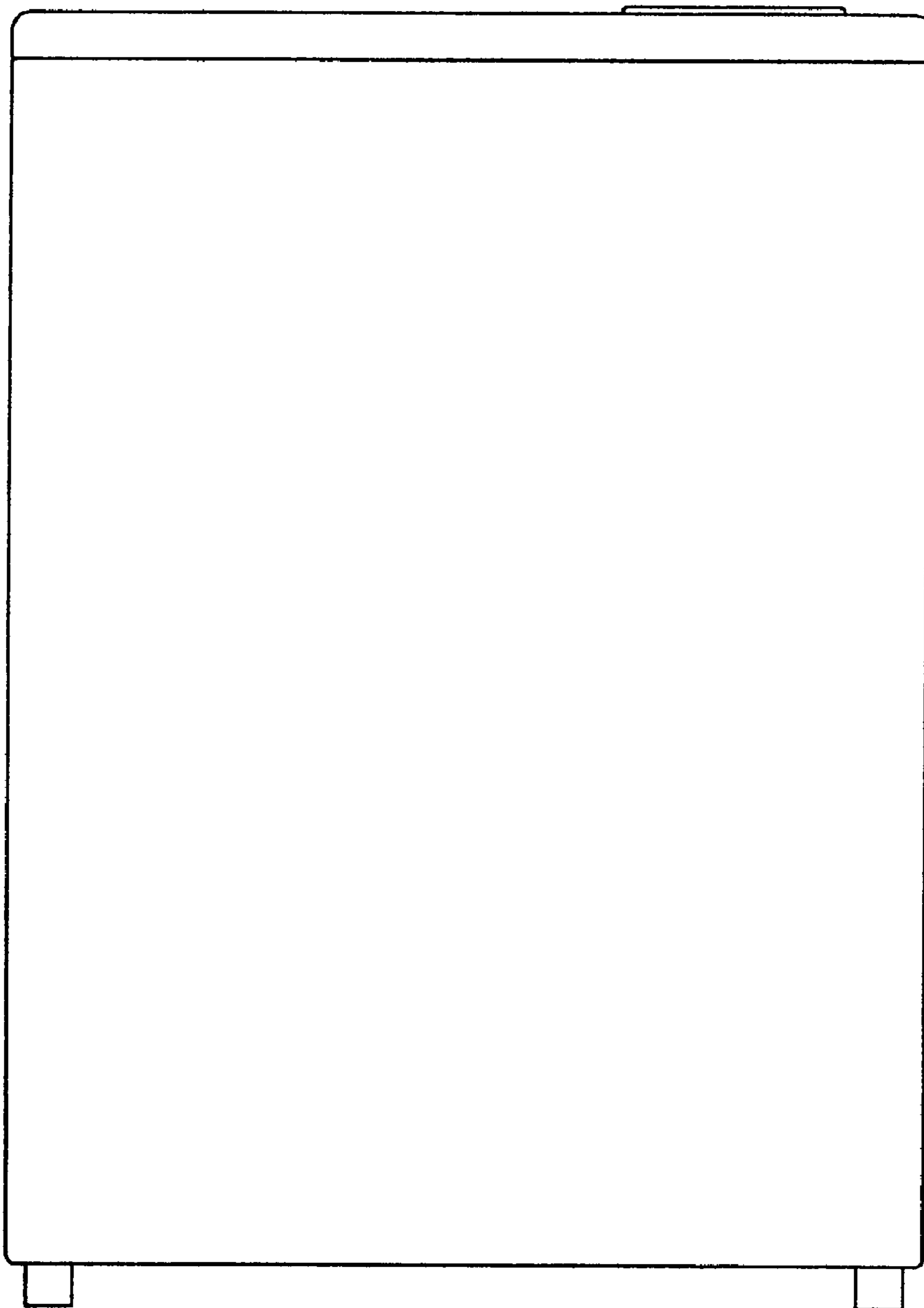

Fig.4

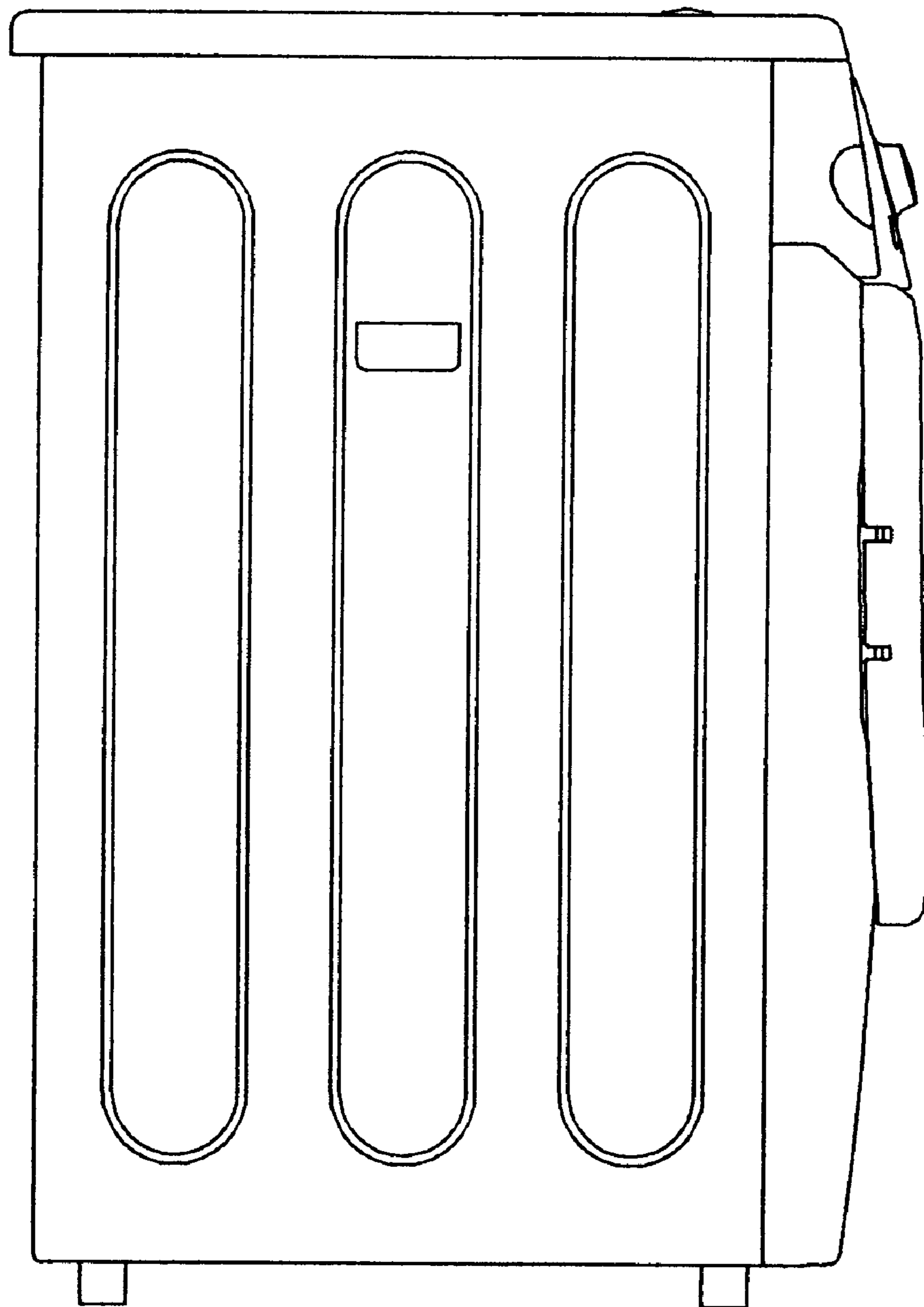

Fig.5

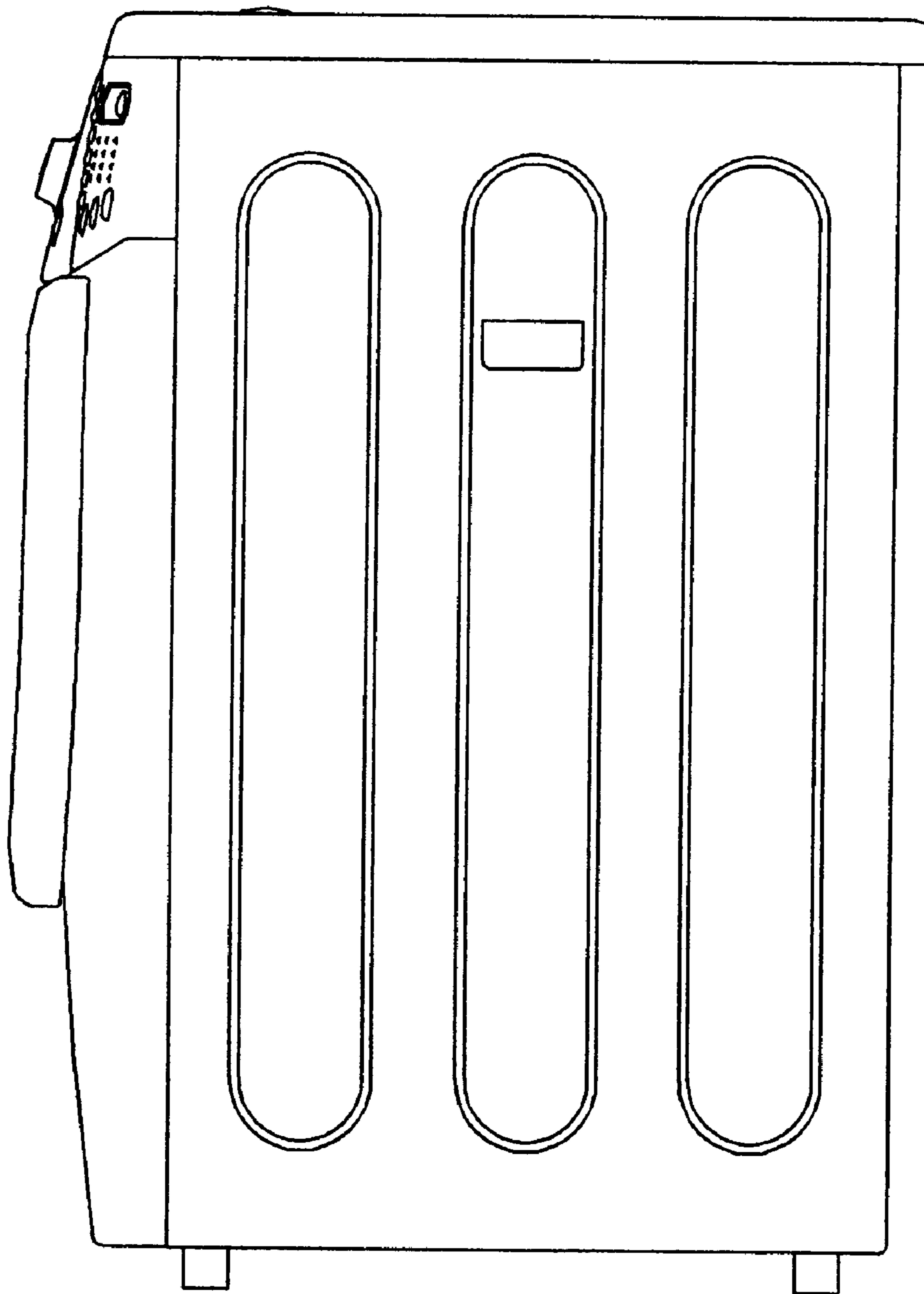

Fig.6

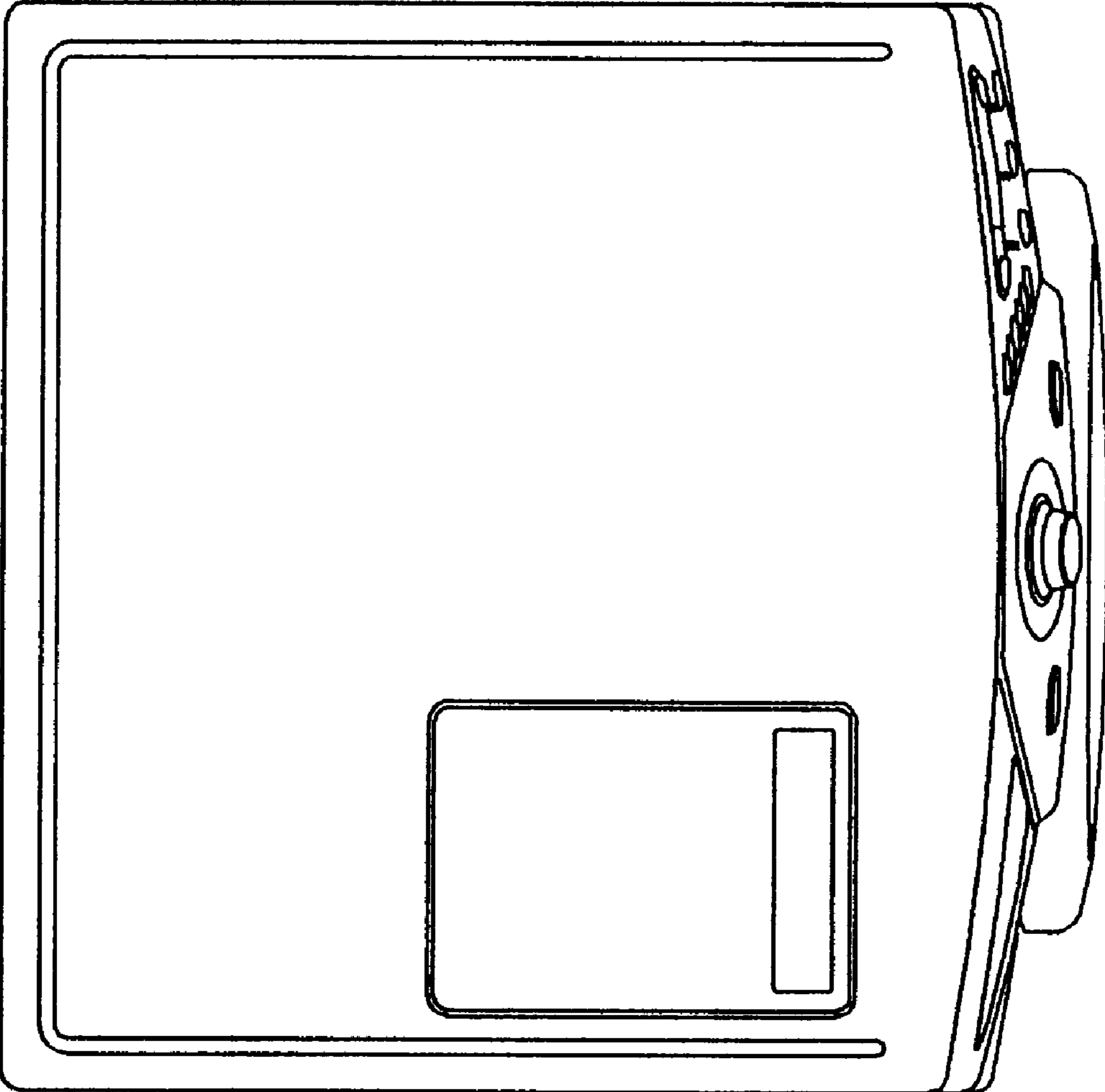

Fig.7

