



US00D517202S

(12) **United States Design Patent** (10) **Patent No.:** **US D517,202 S**
Tai (45) **Date of Patent:** **** Mar. 14, 2006**

(54) **FAN BLADE**

D503,795 S * 4/2005 Tai D23/413
 D505,724 S * 5/2005 Tai D23/413

(75) Inventor: **Jen-Lung David Tai**, Glendale, AZ (US)

* cited by examiner

(73) Assignee: **Air Cool Industrial Co., Ltd.**, Taichung (TW)

Primary Examiner—Lisa Lichtenstein
 (74) *Attorney, Agent, or Firm*—Parsons & Goltry; Michael W. Goltry; Robert A. Parsons

(**) Term: **14 Years**

(57) **CLAIM**

(21) Appl. No.: **29/222,636**

The ornamental design for a fan blade, as shown and described.

(22) Filed: **Feb. 2, 2005**

DESCRIPTION

(51) **LOC (8) Cl.** **23-04**

FIG. 1 is a bottom perspective view of a fan blade showing my new design;

(52) **U.S. Cl.** **D23/413**

FIG. 2 is another perspective view thereof;

(58) **Field of Classification Search** D23/377, D23/379, 385, 413, 411; 416/5

FIG. 3 is a bottom plan view thereof;

See application file for complete search history.

FIG. 4 is a top plan view thereof;

FIG. 5 is a left side elevational view thereof;

FIG. 6 is a right side elevational view thereof;

FIG. 7 is a front elevational view thereof; and,

FIG. 8 is a rear elevational view thereof.

(56) **References Cited**

U.S. PATENT DOCUMENTS

D345,790 S * 4/1994 Caldwell D23/377
 D404,479 S * 1/1999 Yang D23/377

1 Claim, 2 Drawing Sheets

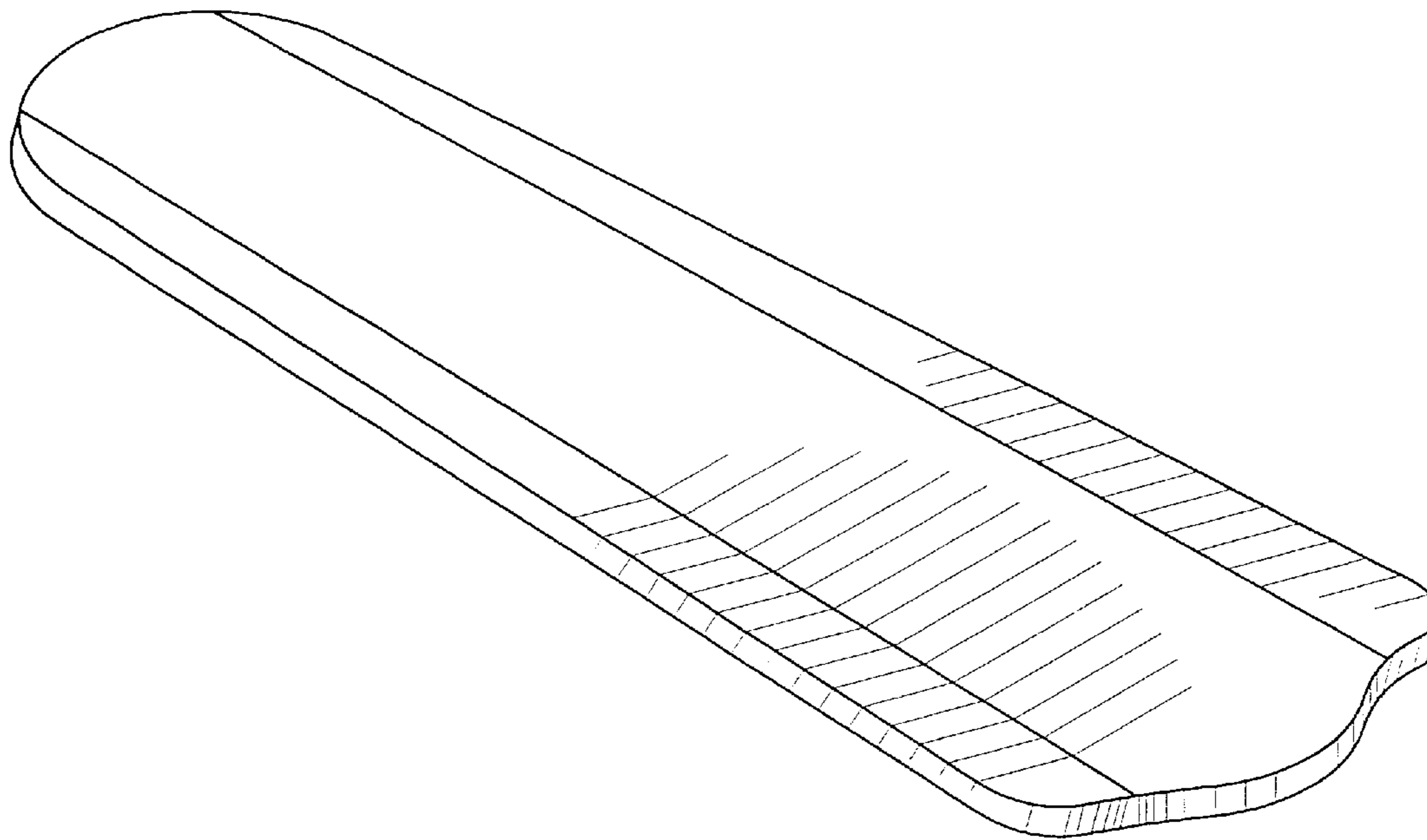

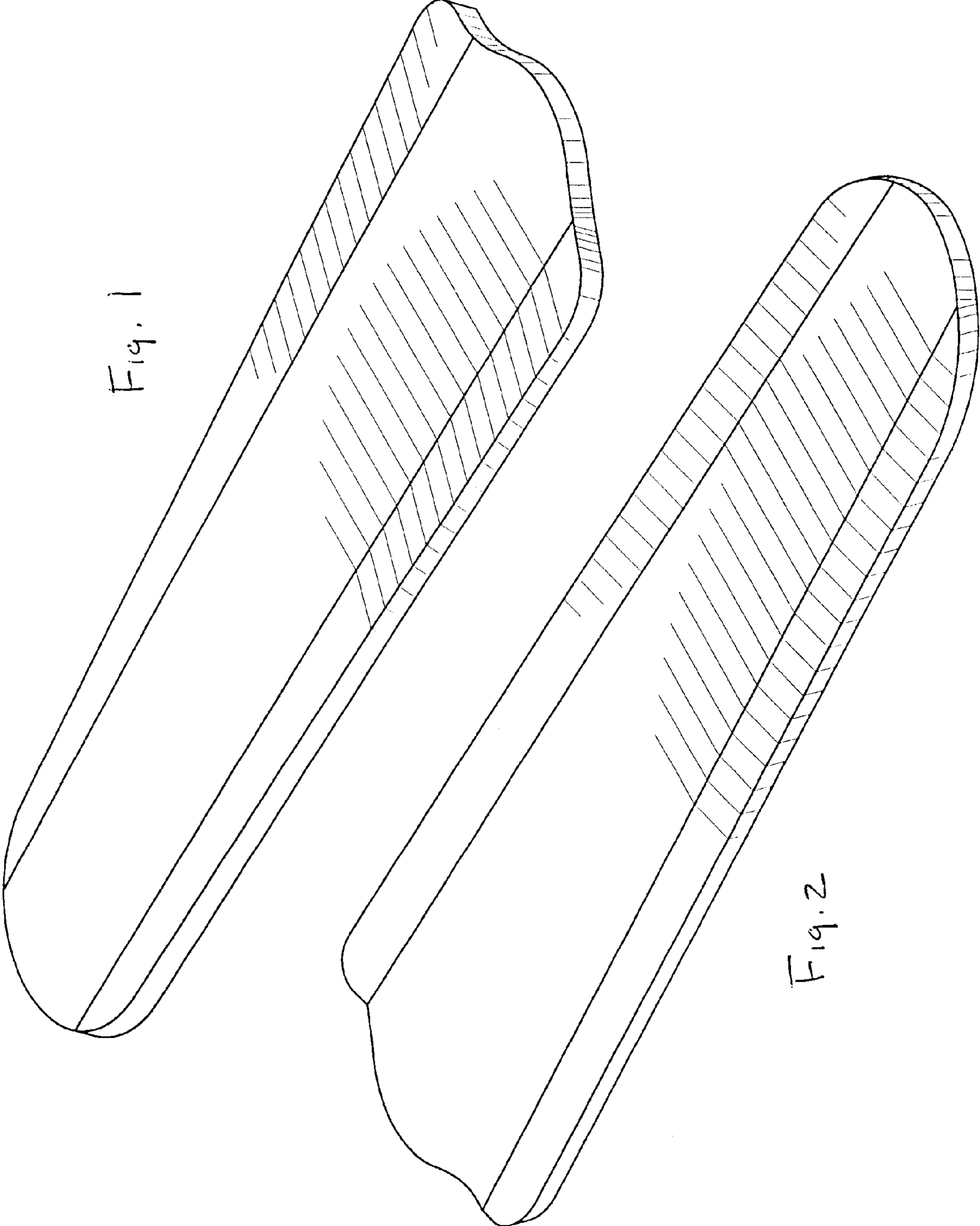

Fig. 8

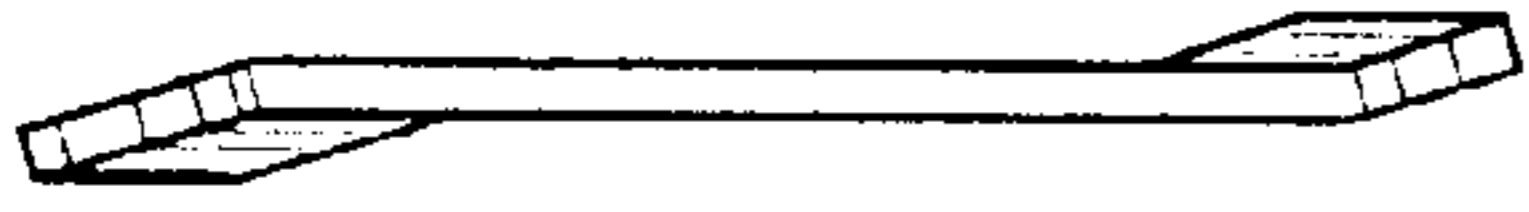

Fig. 3

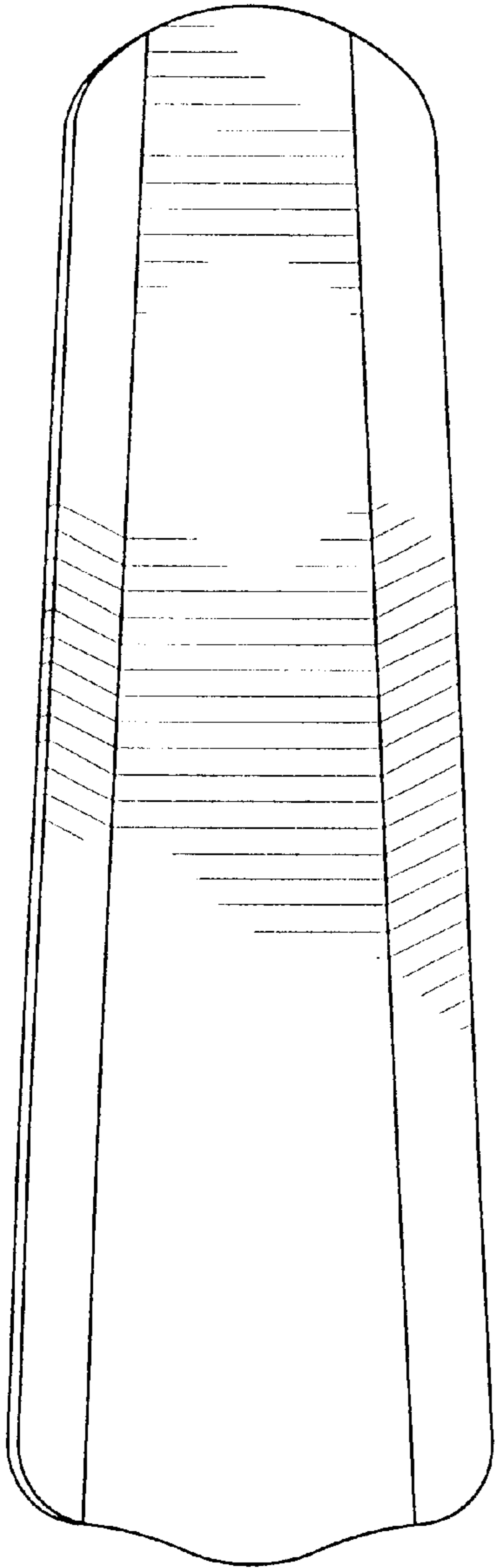

Fig. 5

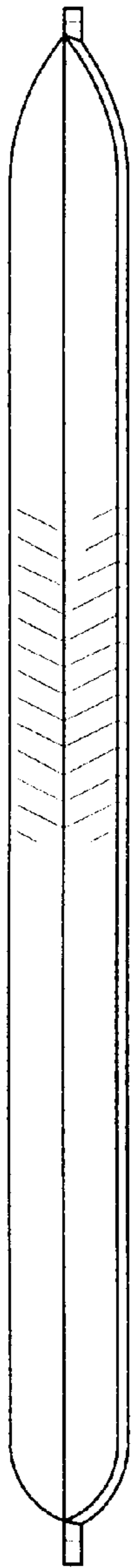

Fig. 4

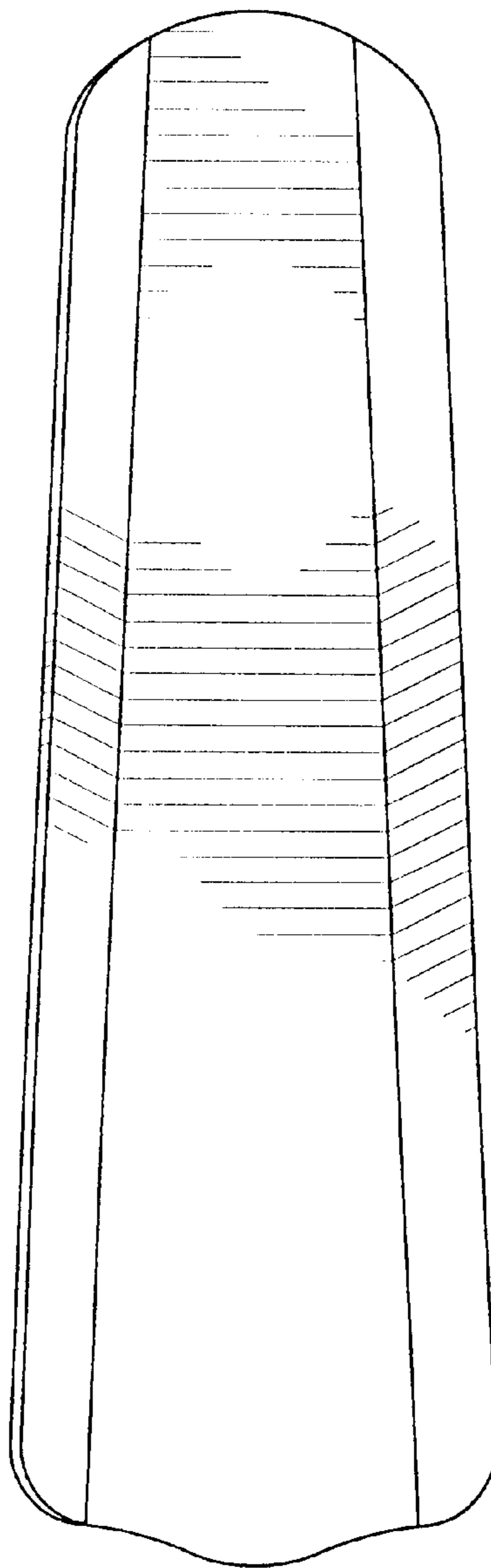

Fig. 6

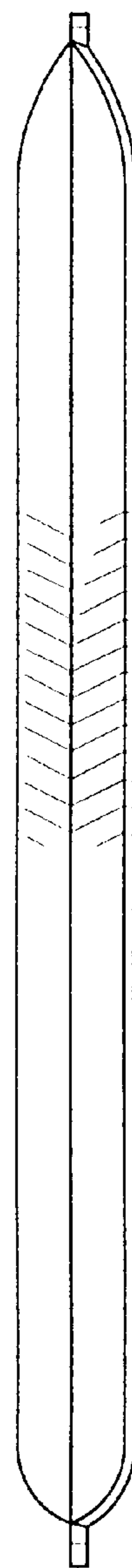

Fig. 7

