

US00D517054S

(12) **United States Design Patent**
Yang

(10) **Patent No.:** **US D517,054 S**
(45) **Date of Patent:** **** Mar. 14, 2006**

(54) **BLUE TOOTH HEADSET**

(75) Inventor: **Bill Yang**, Taipei (TW)

(73) Assignee: **Cotron Corporation**, Taipei (TW)

(**) Term: **14 Years**

(21) Appl. No.: **29/227,328**

(22) Filed: **Apr. 7, 2005**

(51) **LOC (8) Cl.** **14-01**

(52) **U.S. Cl.** **D14/223**; D14/205

(58) **Field of Classification Search** D14/188,
D14/192, 205, 206, 223, 226; 181/129, 130;
379/430, 433; 381/370, 374, 375, 376, 377,
381/378, 379, 380, 381; D24/174
See application file for complete search history.

(56) **References Cited**

U.S. PATENT DOCUMENTS

D460,960 S * 7/2002 Kao D14/223
D471,898 S * 3/2003 Bae D14/223
D479,834 S * 9/2003 Salazar et al. D14/205

D490,398 S * 5/2004 Gwee D14/205
6,760,459 B1 * 7/2004 Bae 381/375
D494,568 S * 8/2004 Pan D14/223
D502,171 S * 2/2005 Tang et al. D14/223
D504,887 S * 5/2005 Skulley D14/223

* cited by examiner

Primary Examiner—Paula A. Greene

(74) *Attorney, Agent, or Firm*—J.C. Patents

(57) **CLAIM**

The ornamental design for a blue tooth headset, as shown and described.

DESCRIPTION

FIG. 1 is a perspective view of a blue tooth headset showing my new design;
FIG. 2 is a front view thereof.
FIG. 3 is a rear view thereof.
FIG. 4 is a left side view thereof.
FIG. 5 is a right side view thereof.
FIG. 6 is a top plan view thereof; and,
FIG. 7 is a bottom plan view thereof.

1 Claim, 7 Drawing Sheets

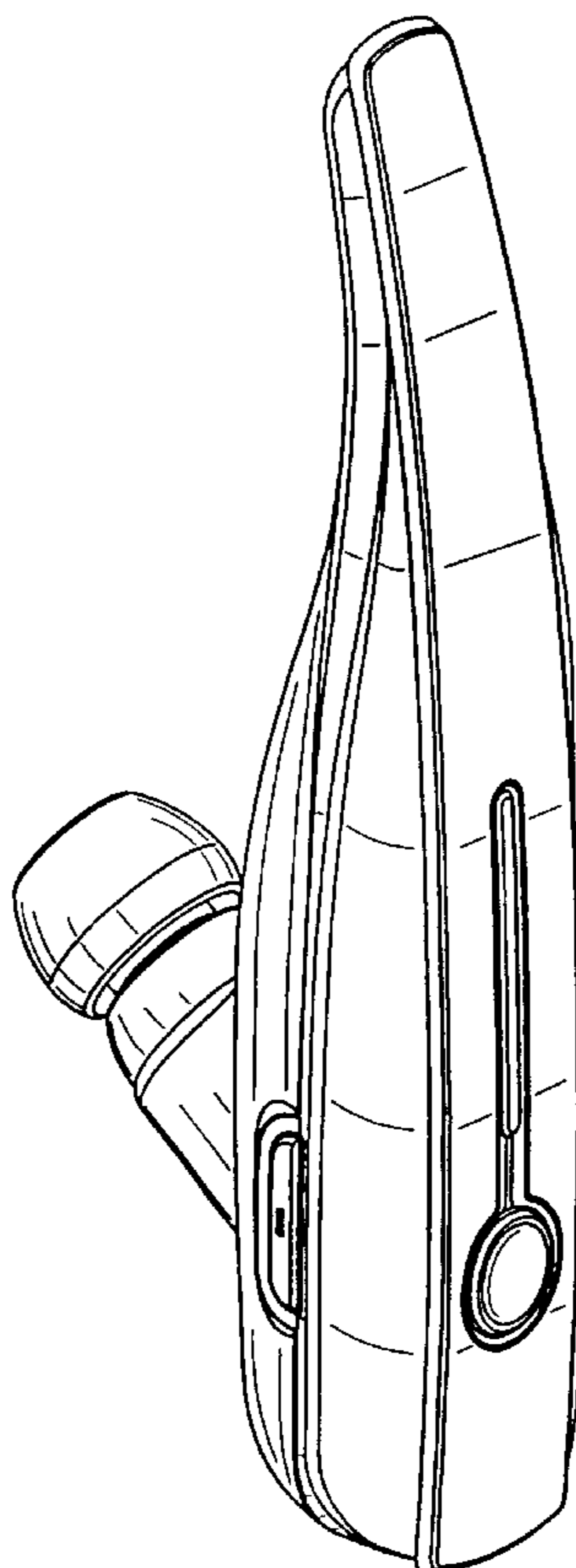

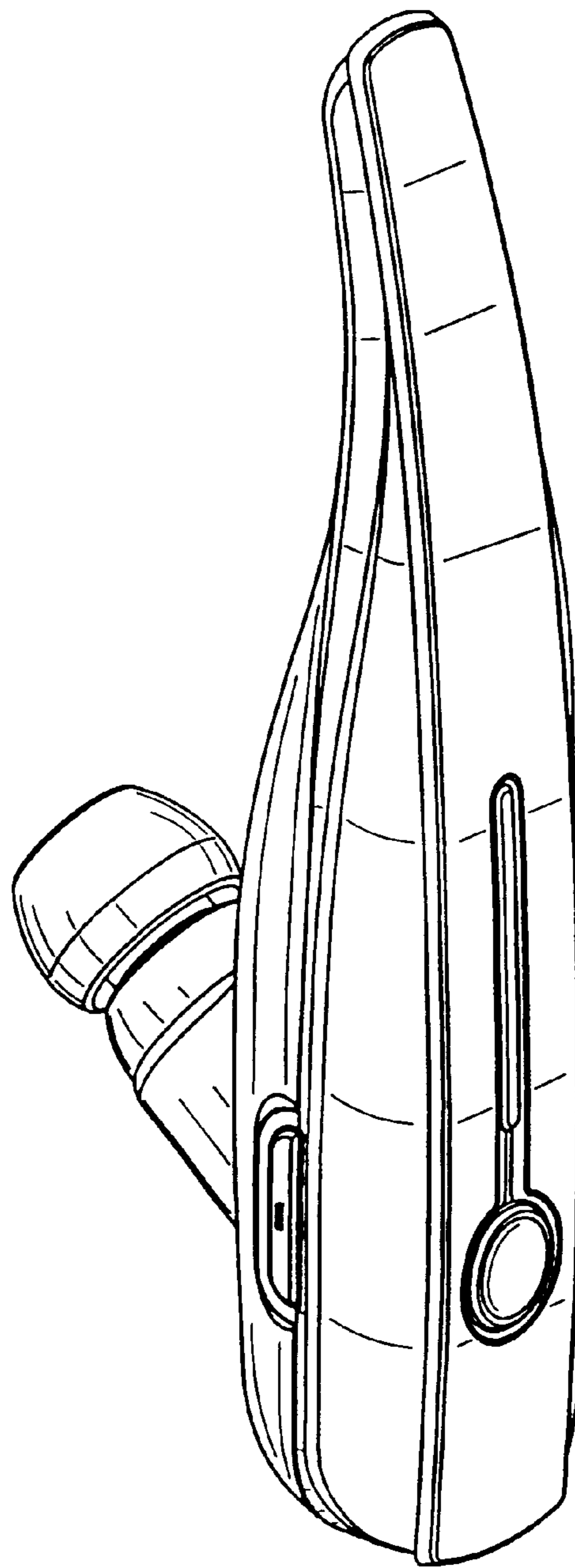

FIG. 1

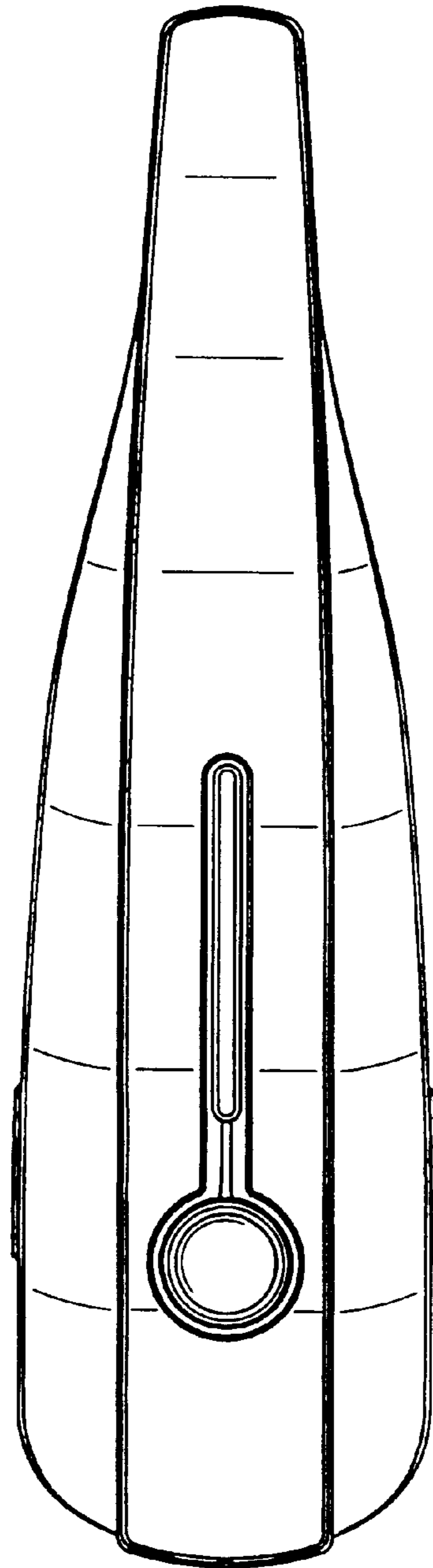

FIG. 2

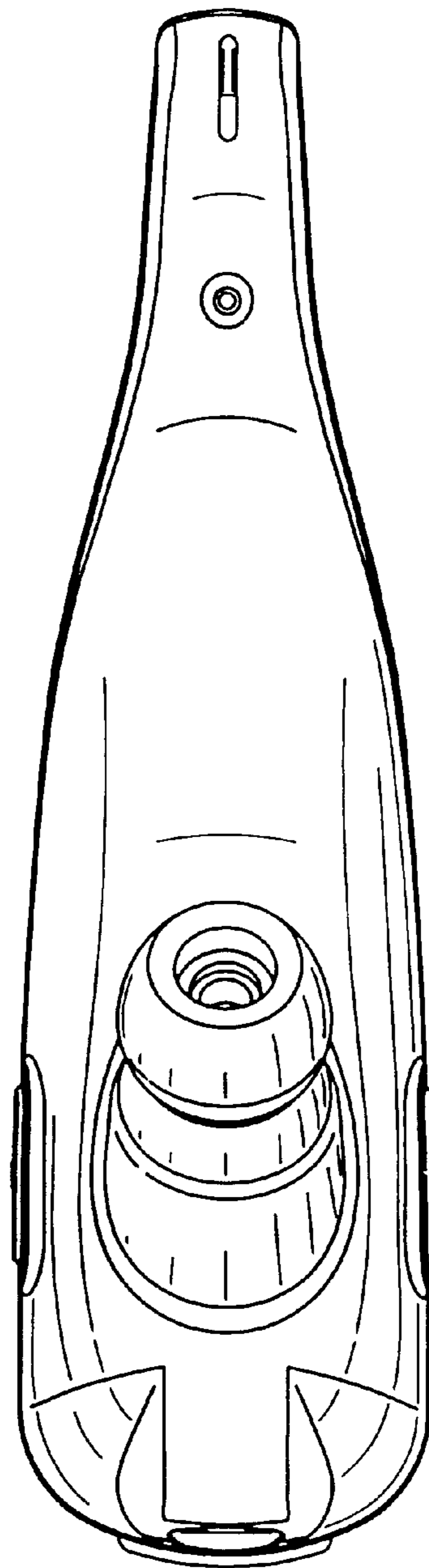

FIG. 3

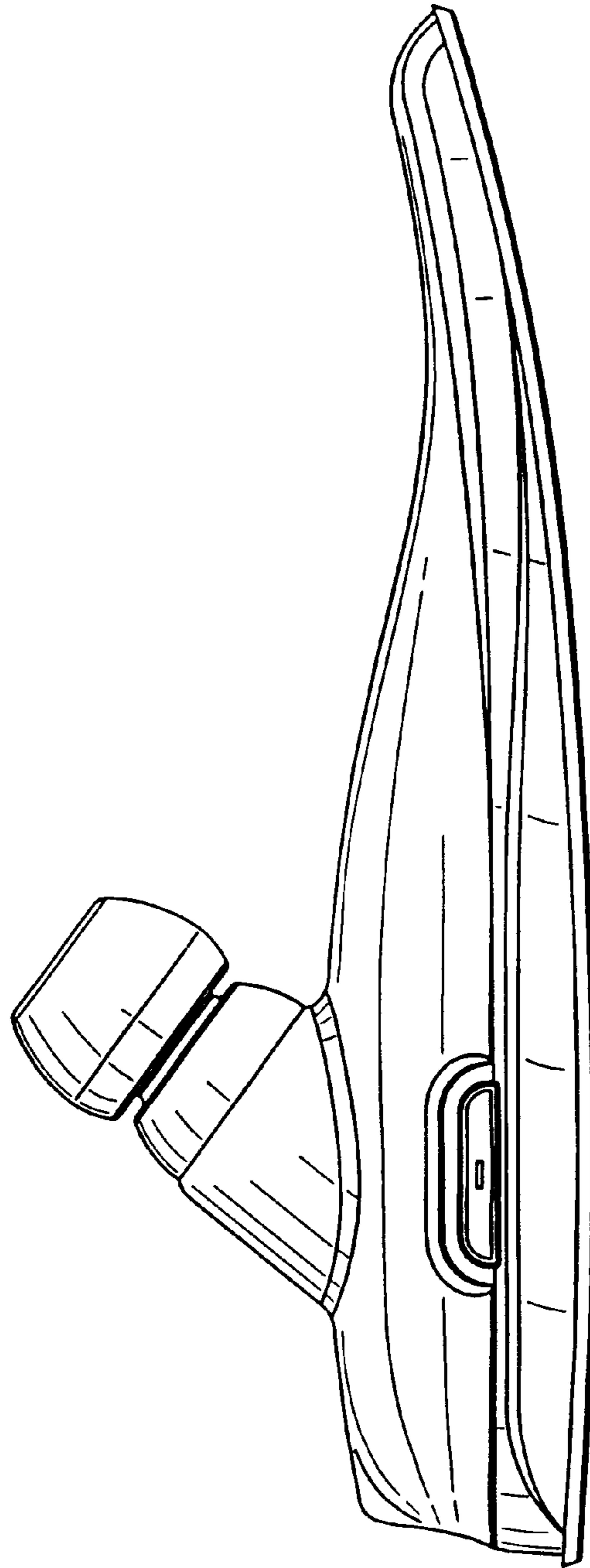

FIG. 4

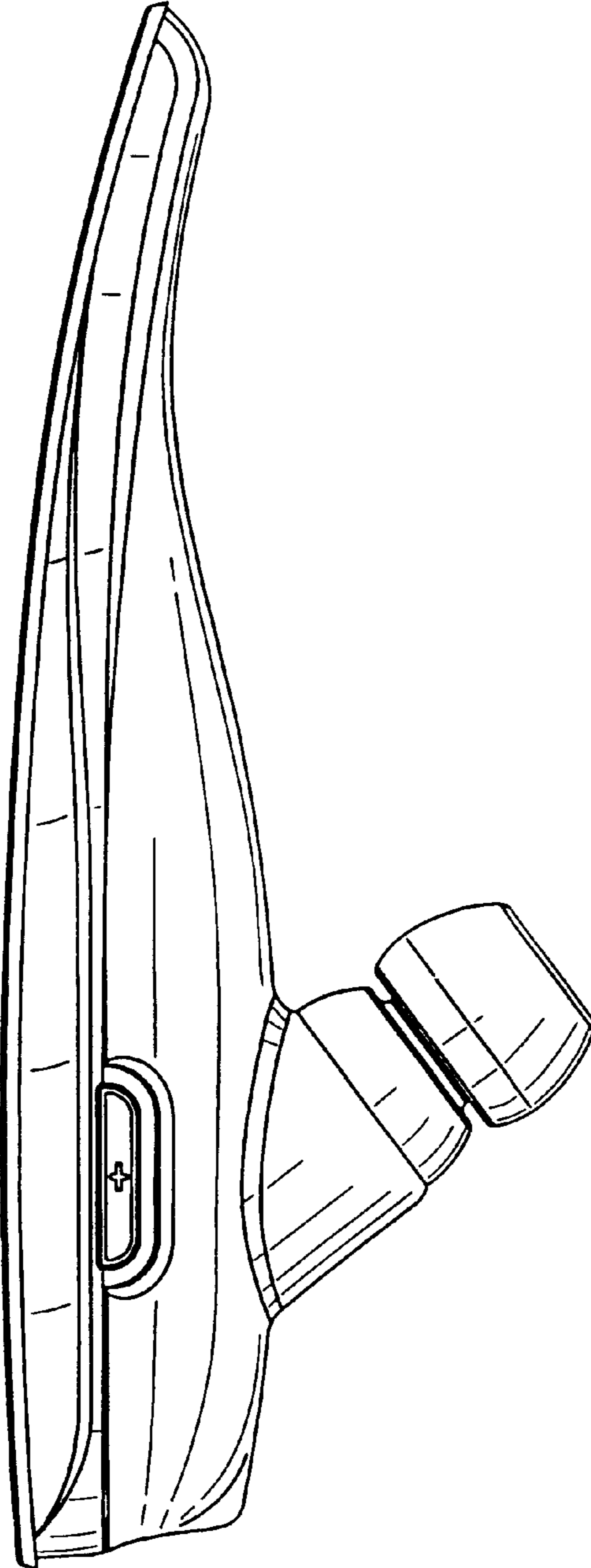

FIG. 5

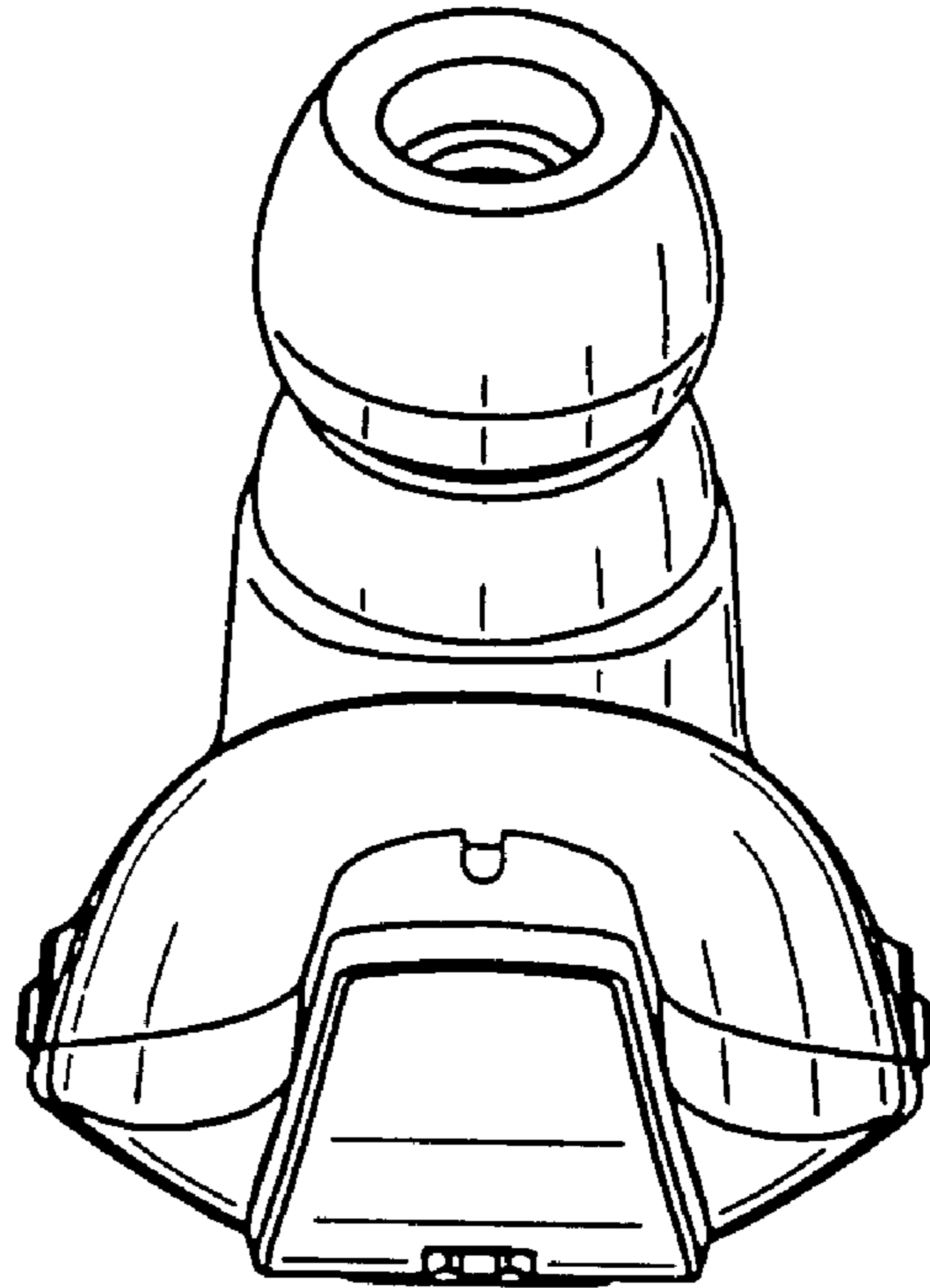

FIG. 6

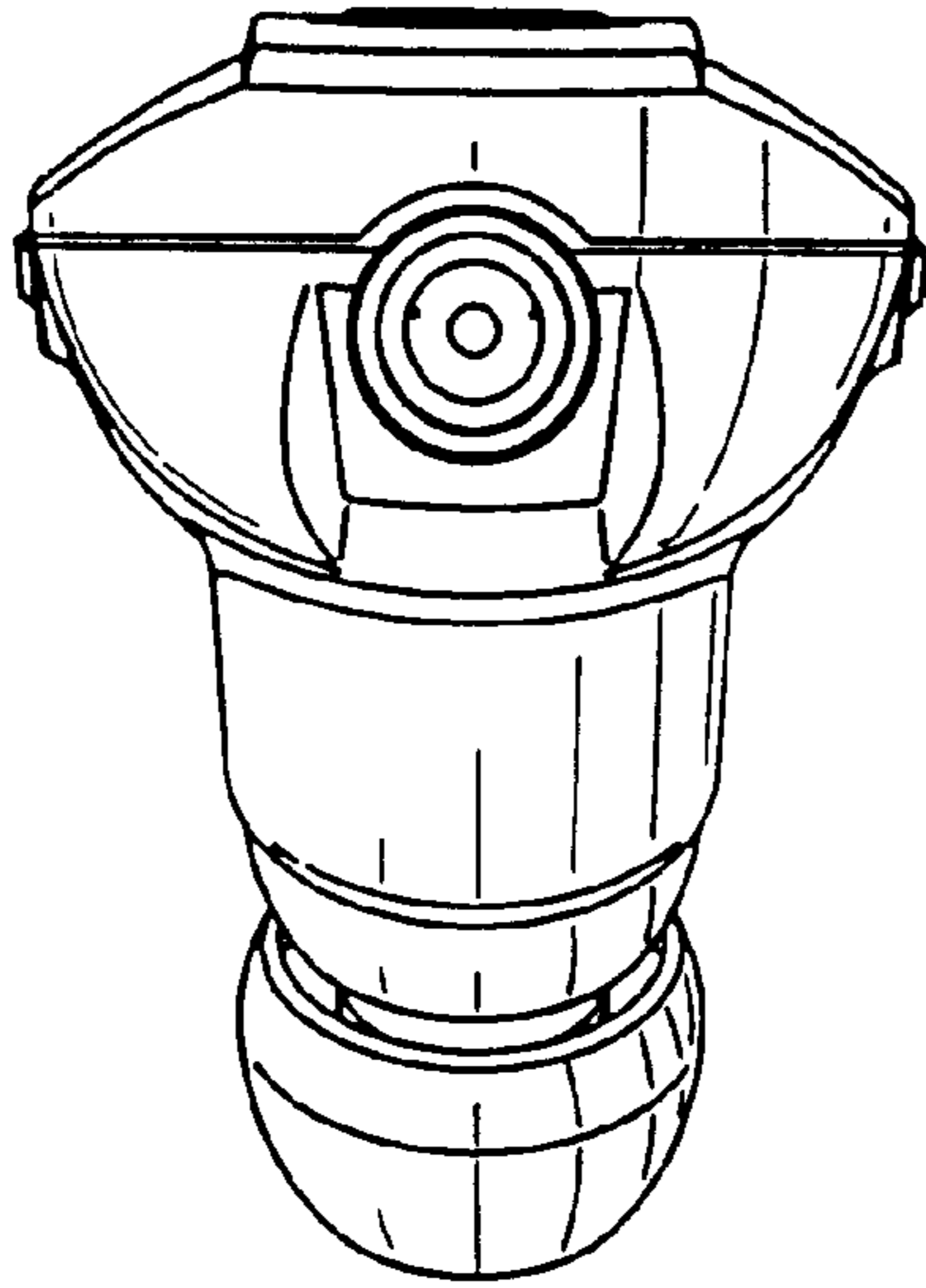

FIG. 7