



US00D517043S

(12) **United States Design Patent**
Jacobson et al.

(10) **Patent No.:** **US D517,043 S**
(45) **Date of Patent:** **** Mar. 14, 2006**

(54) **BEHIND THE HEAD HEADSET**
(75) Inventors: **Robert Jacobson**, Camas, WA (US);
Raymond Weikel, Camas, WA (US);
Dominic Amae, Vancouver, WA (US);
Bernhard Wildner, Portland, OR (US);
Omer Kotzer, Portland, OR (US)

D358,391 S * 5/1995 Isono D14/205
D381,987 S * 8/1997 Tsuge D14/205
D435,249 S * 12/2000 Yasutomi D14/205
D468,722 S * 1/2003 Schmidt et al. D14/205
D484,485 S * 12/2003 Matsuoka D14/205
D504,883 S * 5/2005 Jacobson et al. D14/192

* cited by examiner

(73) Assignee: **Logitech Europe S.A.**,
Romanel-sur-Morges (CH)

Primary Examiner—Paula A. Greene
(74) *Attorney, Agent, or Firm*—Ipsolon LLP

(**) Term: **14 Years**

(57) **CLAIM**

(21) Appl. No.: **29/216,106**

We claim the ornamental design for a behind the head headset, as shown and described.

(22) Filed: **Oct. 26, 2004**

DESCRIPTION

(51) **LOC (8) Cl.** **14-01**
(52) **U.S. Cl.** **D14/205; D14/223**
(58) **Field of Classification Search** D14/192,
D14/205, 206, 223; 181/129, 130, 137; 379/430,
379/431, 444; 381/300, 309, 310, 311, 370,
381/376, 377, 378, 379, 380, 381
See application file for complete search history.

FIG. 1 is a rear, left perspective view of the behind the head headset showing our new design;
FIG. 2 is front, right perspective view thereof;
FIG. 3 is a right side elevation view thereof, the left side elevation view being a mirror image thereof;
FIG. 4 is a bottom elevation view thereof,
FIG. 5 is a back elevation view thereof;
FIG. 6 is a top elevation view thereof; and,
FIG. 7 is a front elevation view thereof.

The broken lines are for illustrative purpose only and form no part of the claimed design.

(56) **References Cited**

U.S. PATENT DOCUMENTS

D345,162 S * 3/1994 Yamatogi D14/205
D351,172 S * 10/1994 Nakamura et al. D14/205

1 Claim, 3 Drawing Sheets

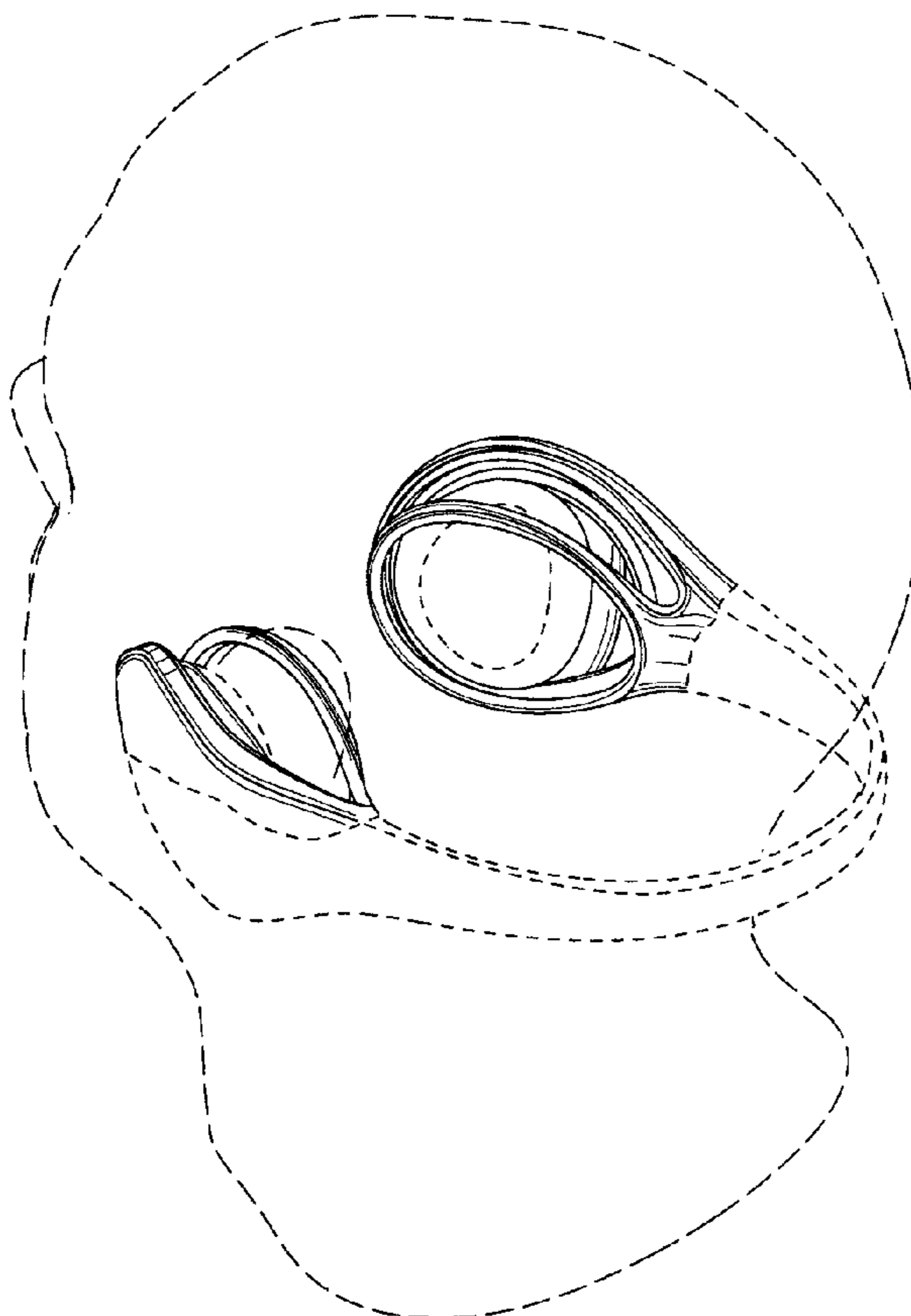

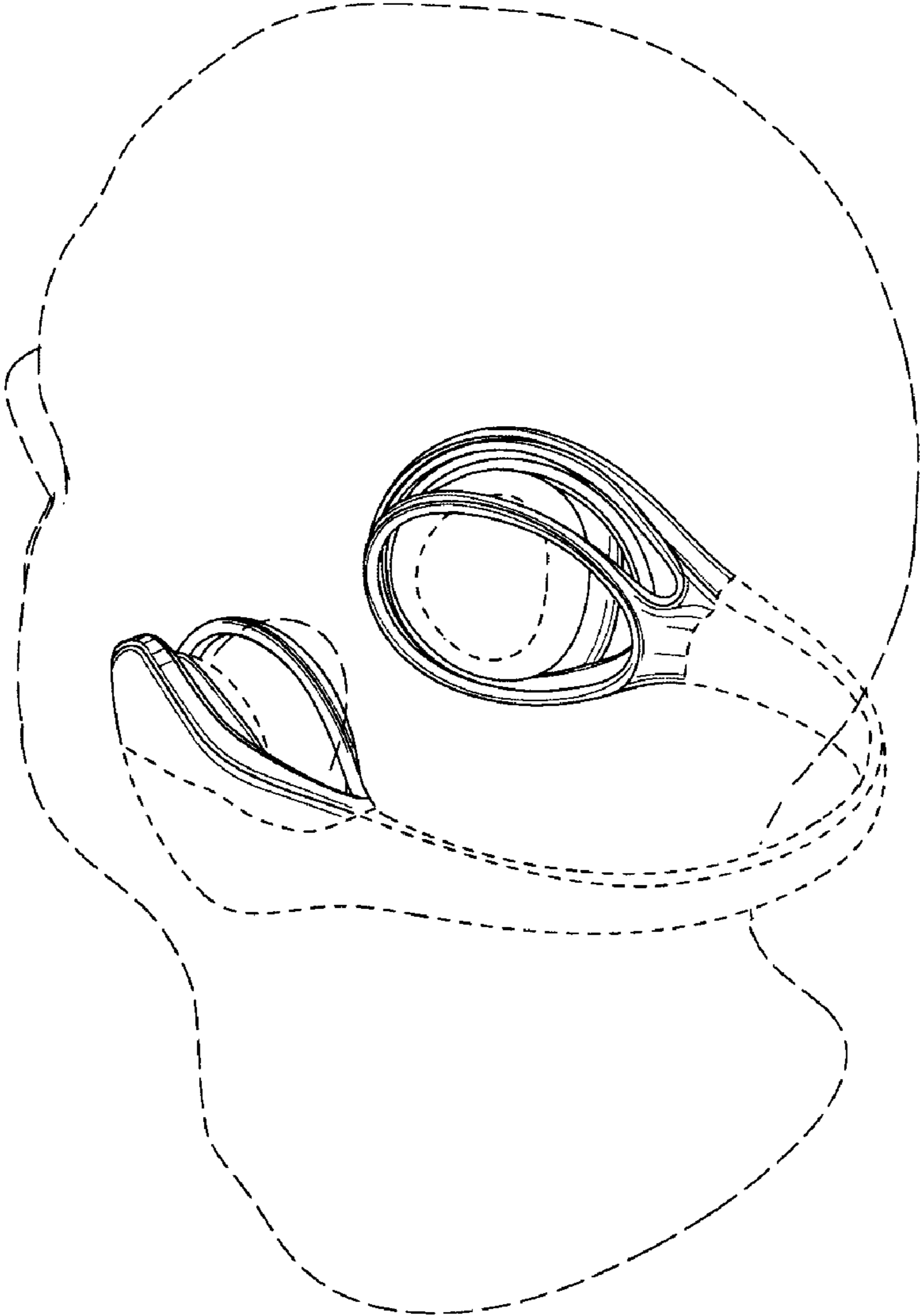

FIG. 1

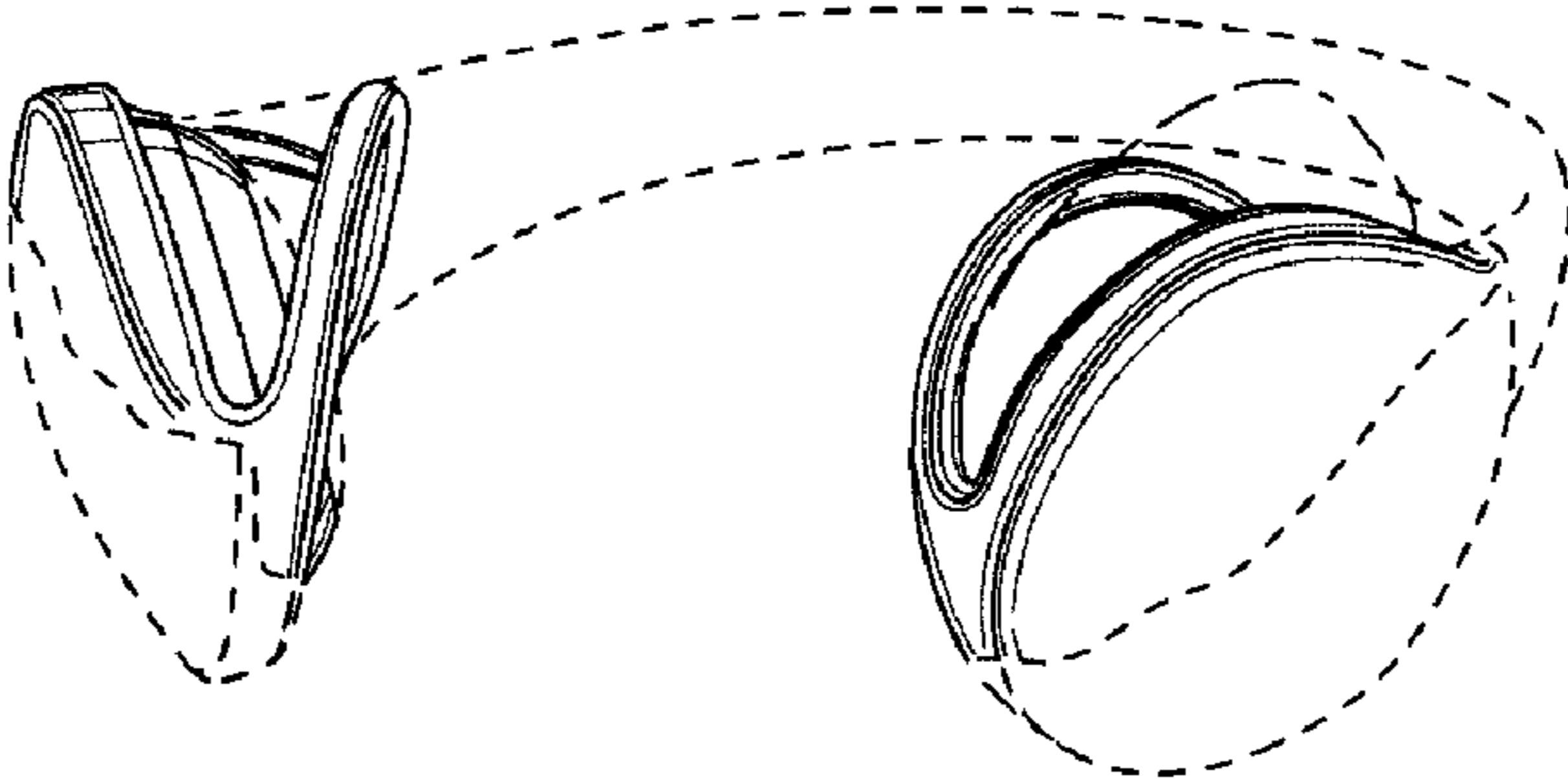

FIG. 2

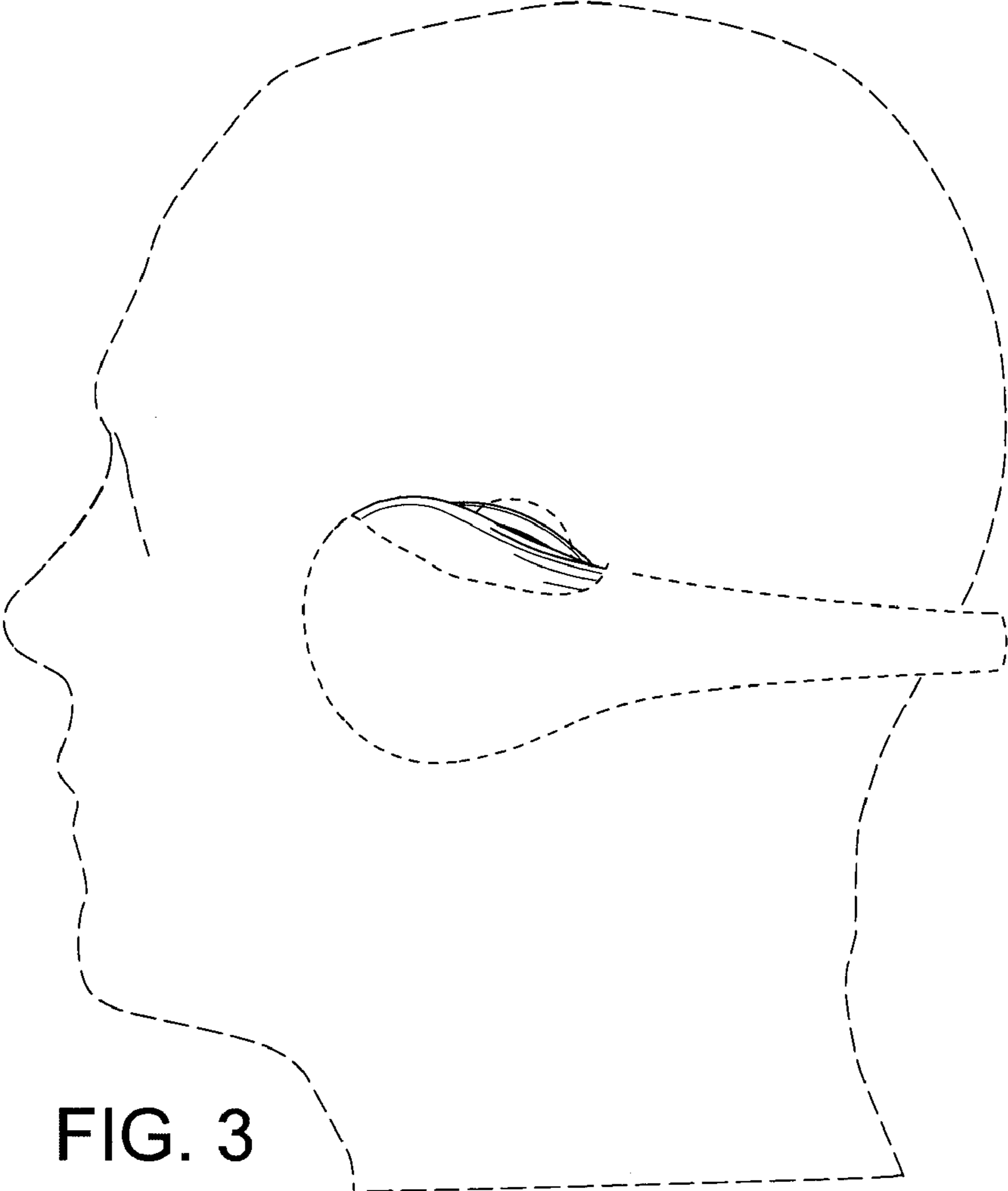

FIG. 3

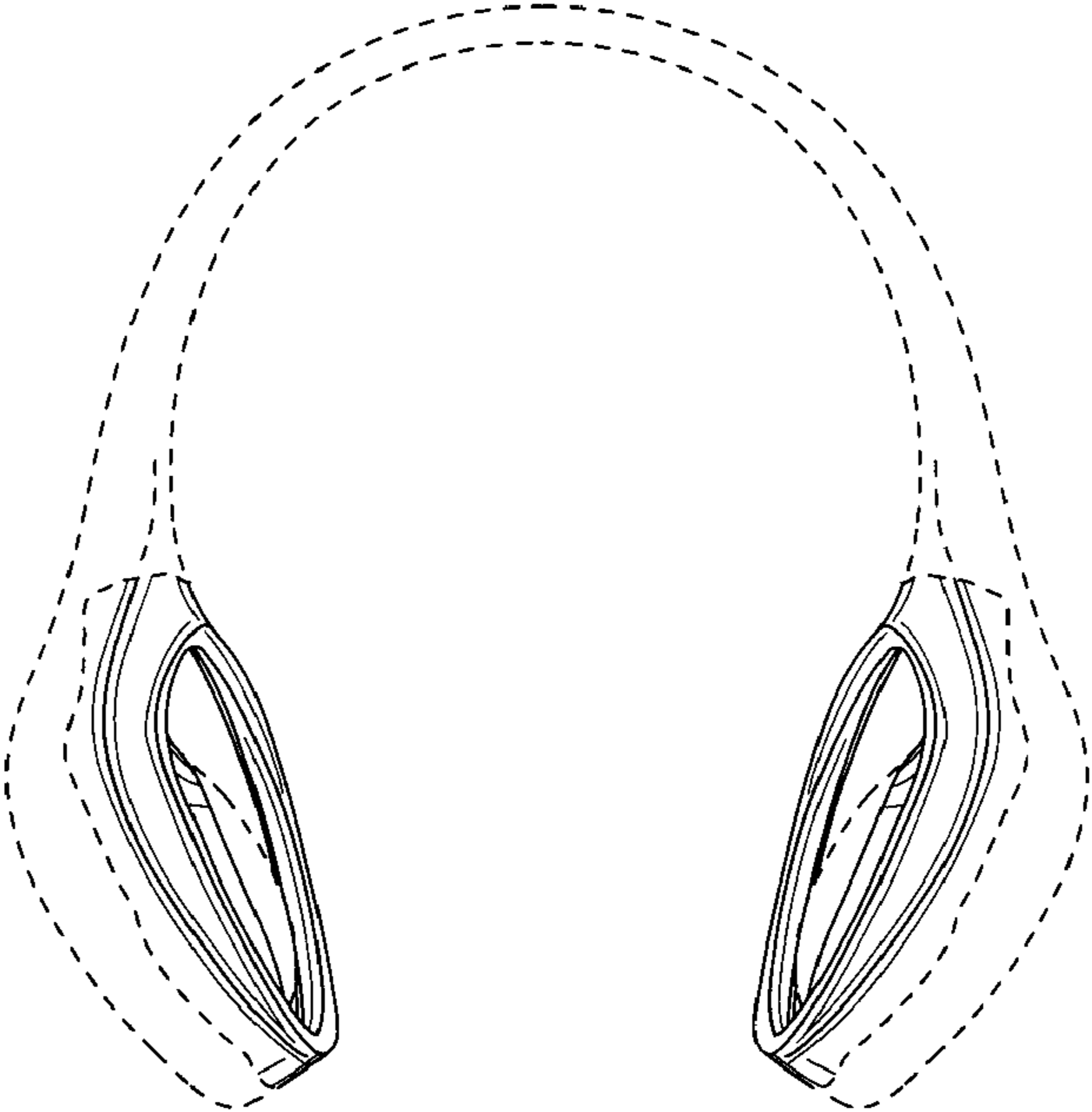

FIG. 4

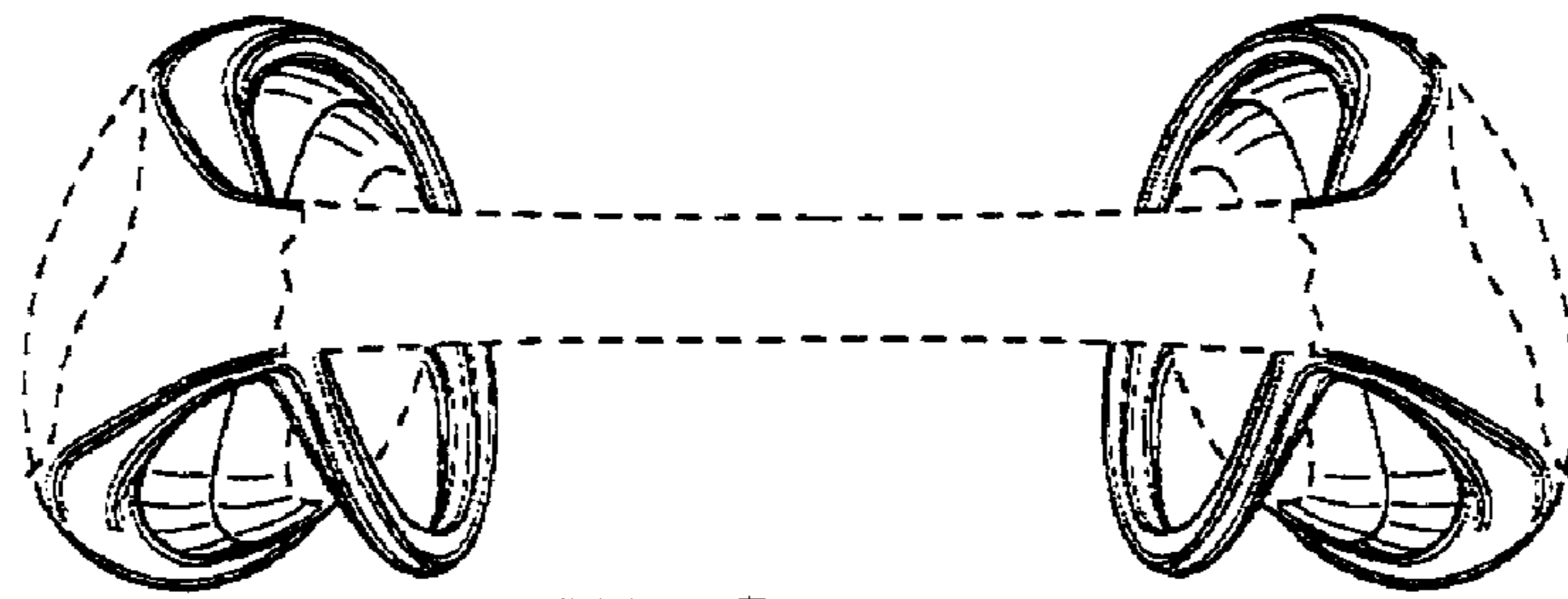

FIG. 6

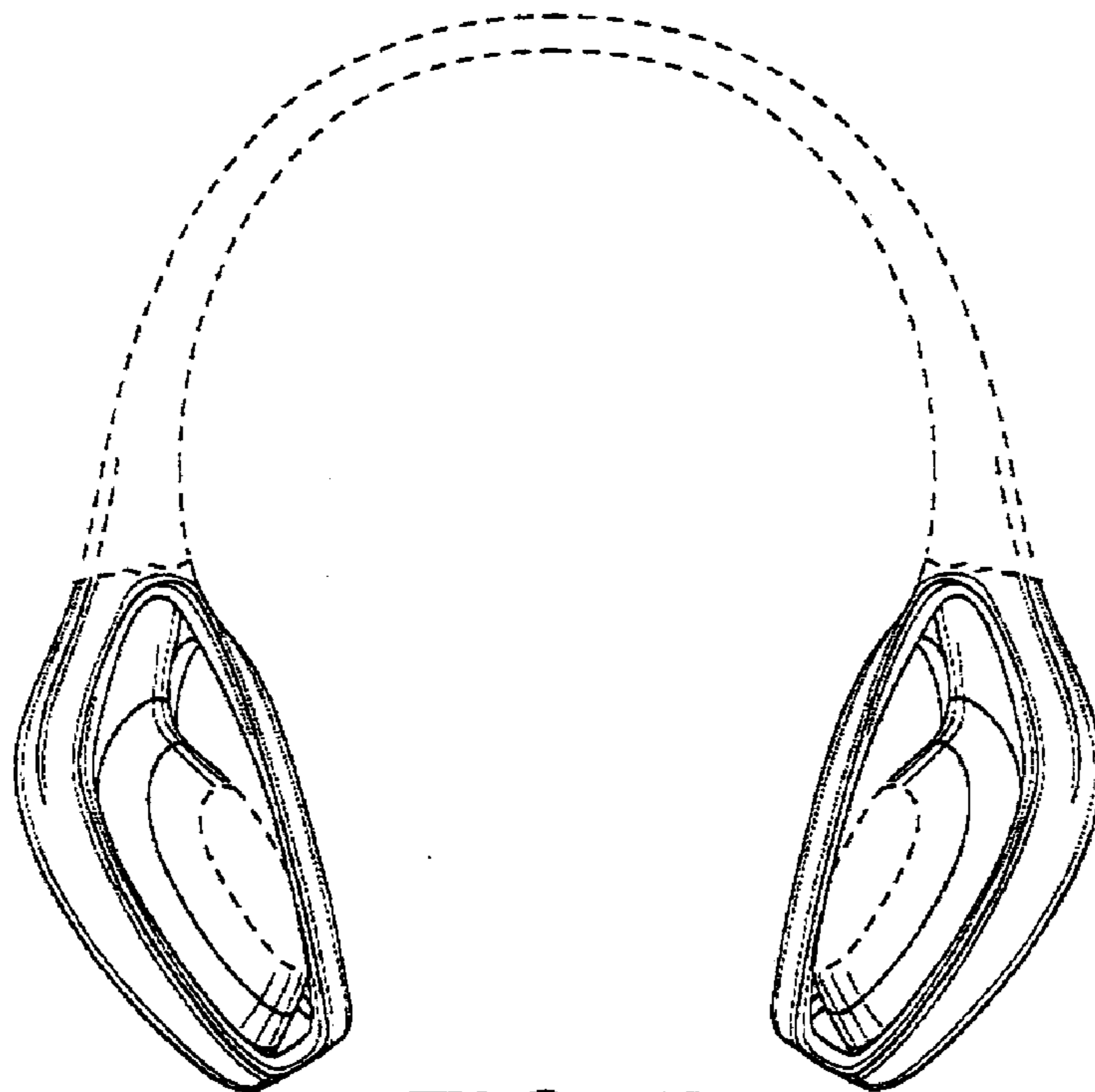

FIG. 5

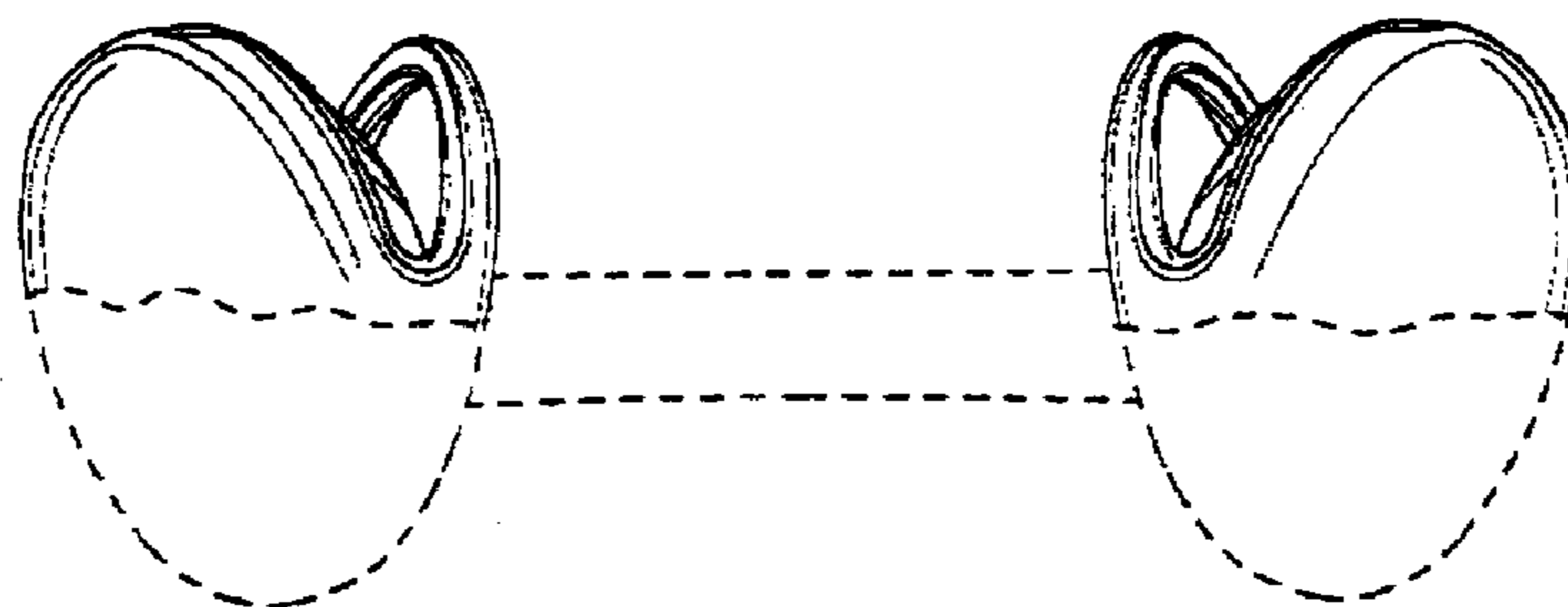

FIG. 7