

US00D516923S

(12) **United States Design Patent**
Moore

(10) **Patent No.:** **US D516,923 S**
(45) **Date of Patent:** **** Mar. 14, 2006**

(54) **VIAL WITH CAP**

(76) **Inventor:** **Kenneth Simon Aylett Moore**, Little Purnel, Bucklers Hard, Beaulieu Hampshire (GB), SO42 7XA

(**) **Term:** **14 Years**

(21) **Appl. No.:** **29/213,288**

(22) **Filed:** **Sep. 14, 2004**

(51) **LOC (8) Cl.** **09-01**

(52) **U.S. Cl.** **D9/682**

(58) **Field of Classification Search** D9/682, D9/685, 686, 687-690, 448, 523; D24/110, D24/114-115, 121; D28/91.1; 222/321.7, 222/321.8, 321.9, 386, 402.1
See application file for complete search history.

(56) **References Cited**

U.S. PATENT DOCUMENTS

D264,307 S	5/1982	Capelouto	D9/352
D333,975 S	3/1993	Moore	D9/300
D365,020 S	* 12/1995	Dinand	D9/689
D376,105 S	12/1996	Thompson	D9/529
D399,130 S	* 10/1998	Monaghan	D9/686
D401,501 S	11/1998	Nagayoshi	D9/300
D403,965 S	1/1999	Bright et al.	D9/503
D411,100 S	* 6/1999	Torres	D9/692

D426,768 S	*	6/2000	Gattineri	D9/690
D427,899 S		7/2000	Bougamont et al.	D9/300
D440,150 S	*	4/2001	Tsai	D9/689
6,305,580 B1	*	10/2001	Chen	222/162

* cited by examiner

Primary Examiner—Stella Reid

Assistant Examiner—Jean E. McCormick

(74) *Attorney, Agent, or Firm*—Sullivan & Worcester LLP

(57) **CLAIM**

The ornamental design for a vial with cap, as shown and described.

DESCRIPTION

FIG. 1 is a perspective view of a vial with cap showing my new design;
FIG. 2 is a side view thereof;
FIG. 3 is a side view thereof;
FIG. 4 is a bottom view thereof;
FIG. 5 is a top view thereof;
FIG. 6 is a perspective view thereof of a vial with the cap removed;
FIG. 7 is a side view thereof;
FIG. 8 is a side view thereof;
FIG. 9 is a bottom view thereof; and,
FIG. 10 is a top view thereof.

1 Claim, 2 Drawing Sheets

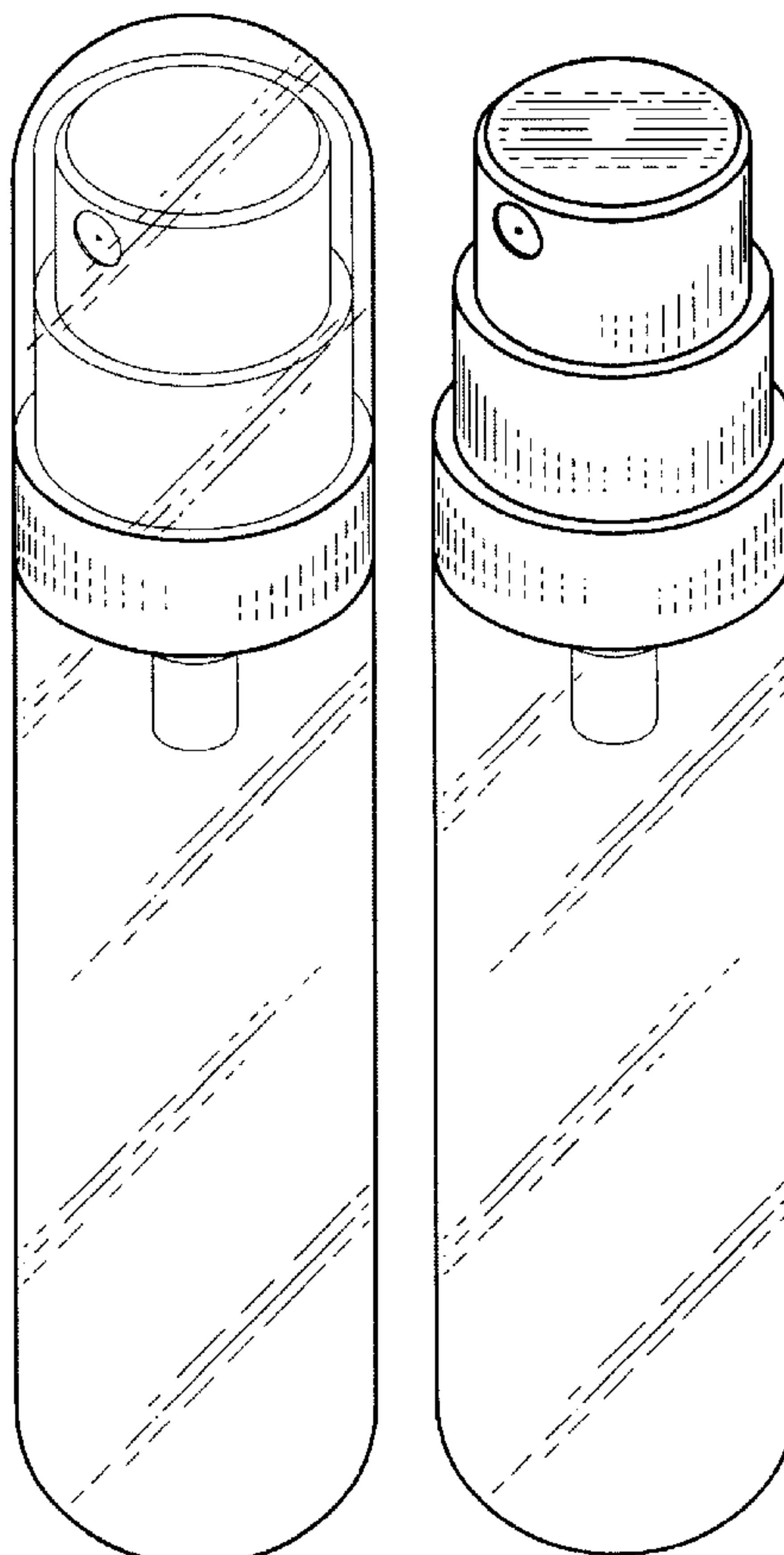

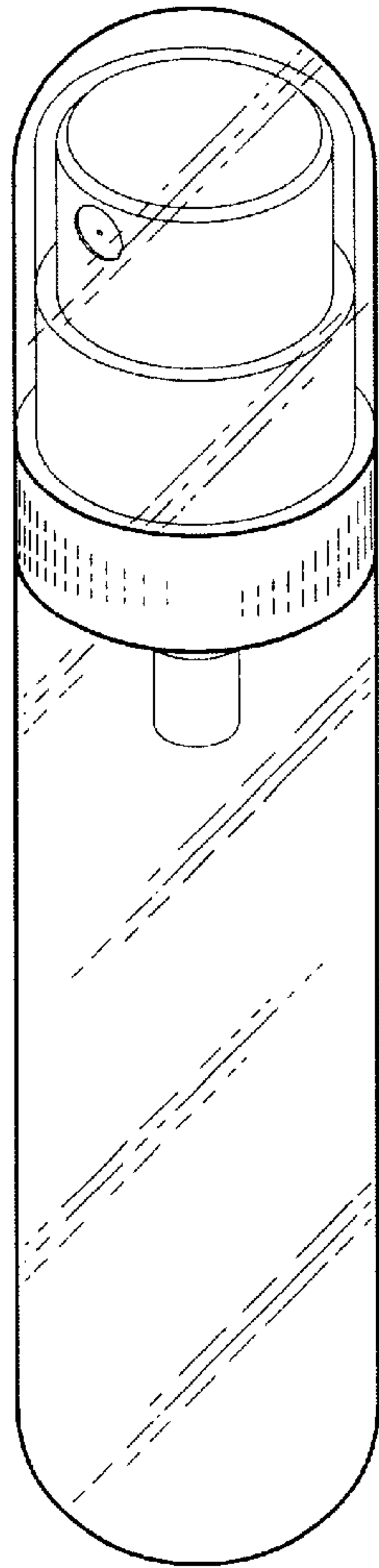

FIG. 1

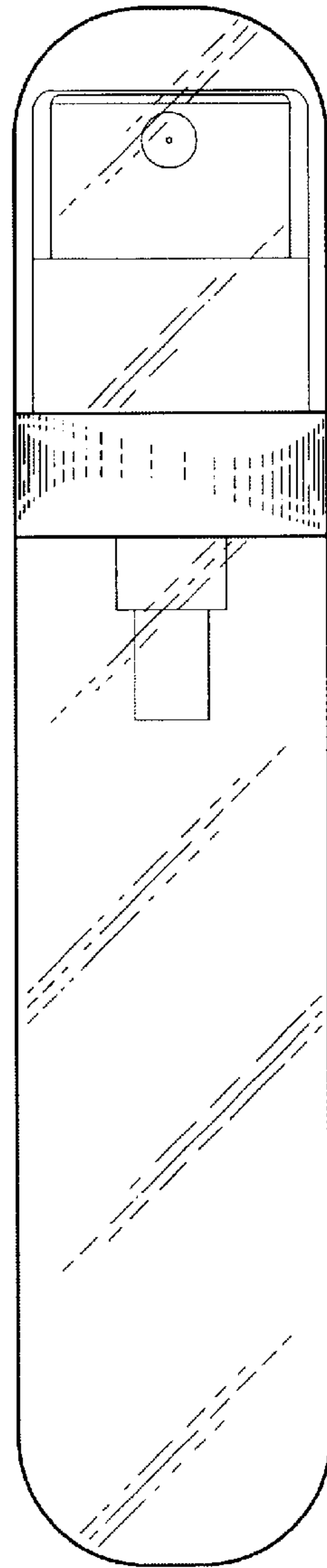

FIG. 2

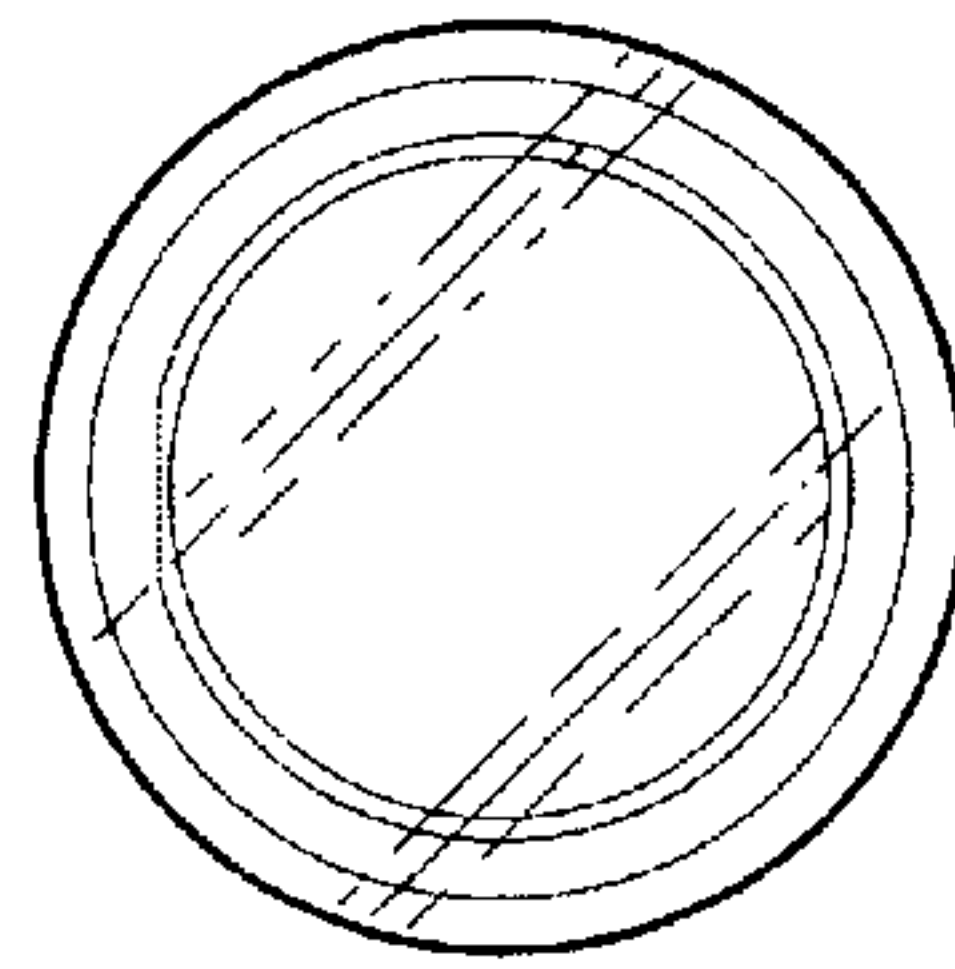

FIG. 5

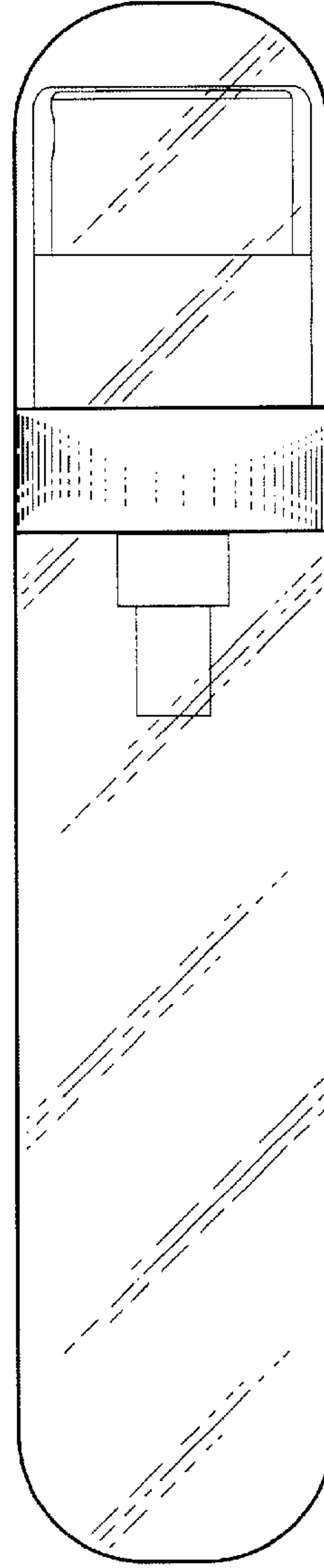

FIG. 3

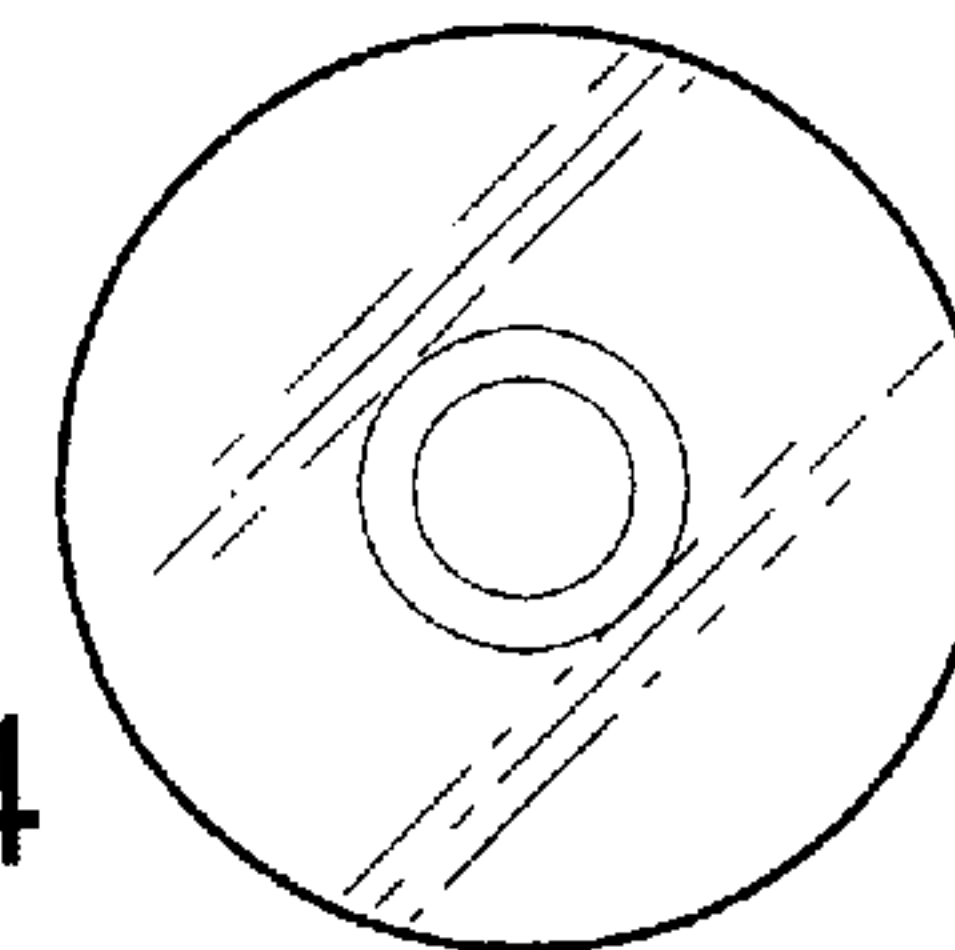

FIG. 4

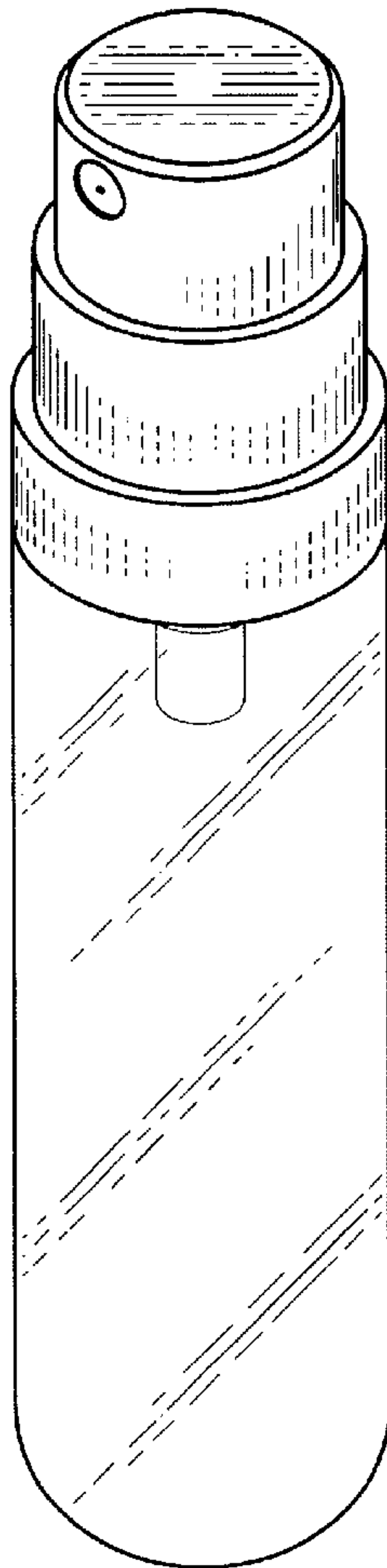

FIG. 6

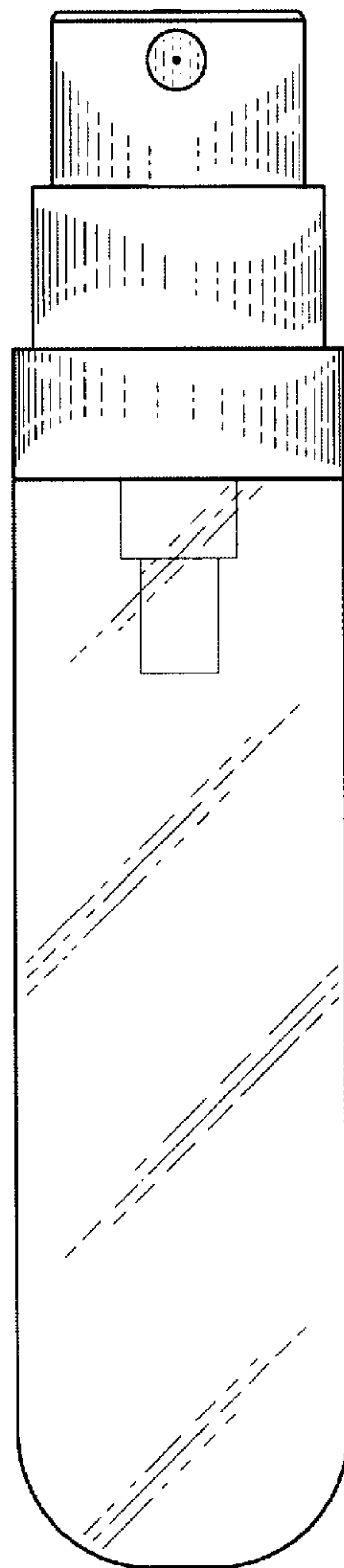

FIG. 7

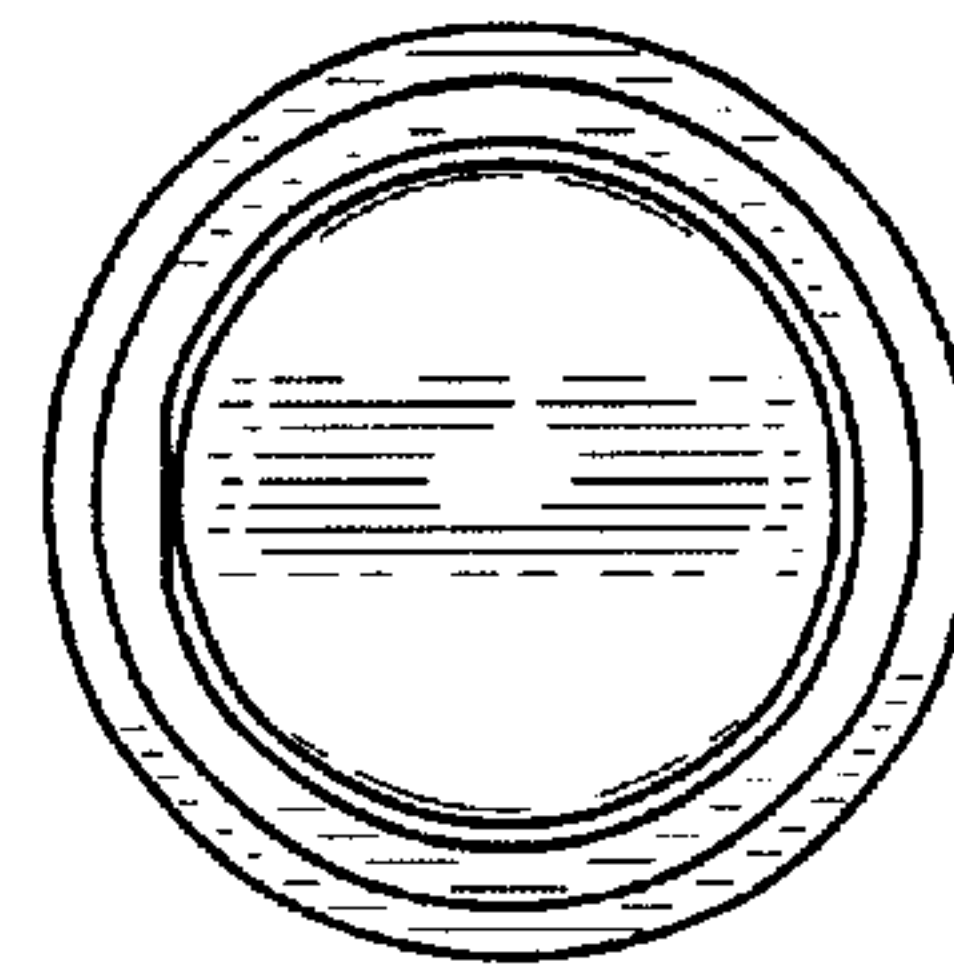

FIG. 10

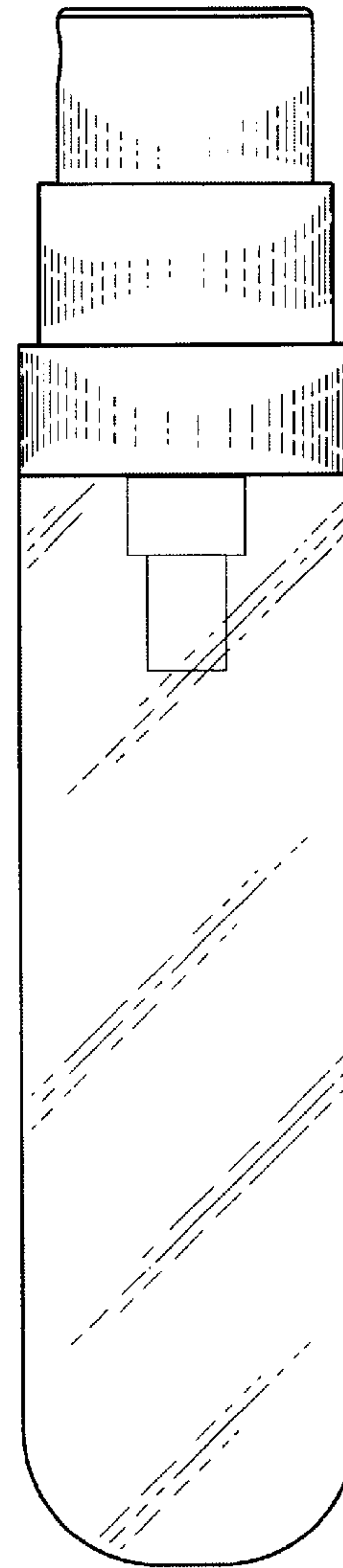

FIG. 8

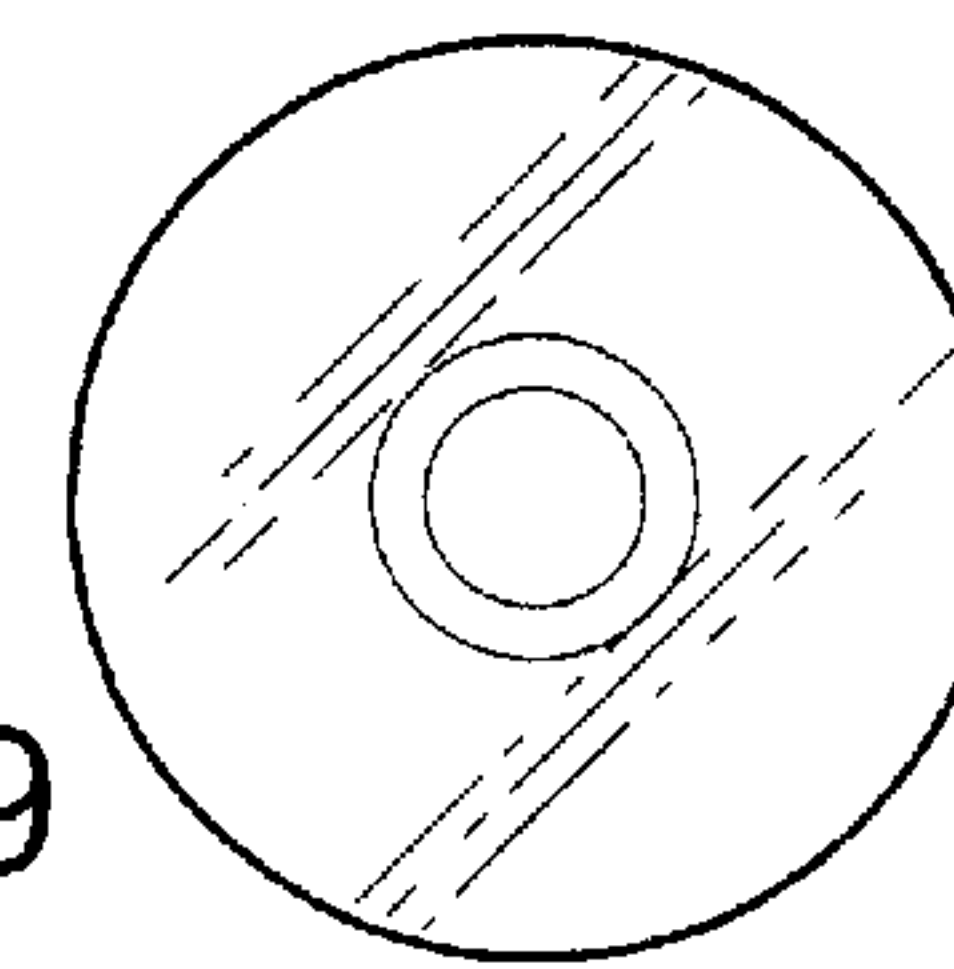

FIG. 9