



US00D516883S

(12) **United States Design Patent**  
**Popov et al.**

(10) **Patent No.:** **US D516,883 S**  
(45) **Date of Patent:** **\*\* Mar. 14, 2006**

(54) **HEAT GUN**  
(75) Inventors: **Borislav Popov**, Causeway Bay (HK);  
**Taku Ohi**, Greer, SC (US); **Kenneth M. Brazell**, Piedmont, SC (US)

D388,298 S \* 12/1997 Jerdee et al. .... D8/29.1  
D457,044 S \* 5/2002 Cheng ..... D8/29.1  
D457,407 S 5/2002 Pretzell  
D461,383 S 8/2002 Blackburn  
D481,277 S \* 10/2003 Waldron ..... D8/29.1

(73) Assignee: **One World Technologies Limited**,  
Hamilton (BM)

\* cited by examiner

(\*\*) Term: **14 Years**

*Primary Examiner*—Philip S. Hyder

(21) Appl. No.: **29/212,033**

(74) *Attorney, Agent, or Firm*—Brinks Hofer Gilson & Lione

(22) Filed: **Aug. 24, 2004**

(57) **CLAIM**

(51) **LOC (8) Cl.** ..... **08-05**

We claim the ornamental design for a heat gun, as shown and described.

(52) **U.S. Cl.** ..... **D8/29.1**

**DESCRIPTION**

(58) **Field of Classification Search** ..... D8/29.1,  
D8/30; D28/13; 392/385; 431/158, 255, 353,  
431/354; 219/227

FIG. 1 is a top perspective view of first embodiment of a heat gun of the present invention;  
FIG. 2 is a top view thereof;  
FIG. 3 is a first side view thereof;  
FIG. 4 is a bottom view thereof;  
FIG. 5 is a second side view thereof;  
FIG. 6 is a front view thereof;  
FIG. 7 is a rear view thereof;  
FIG. 8 is a top perspective view of a second embodiment of a heat gun of the present invention;  
FIG. 9 is a top view thereof;  
FIG. 10 is a first side view thereof;  
FIG. 11 is a bottom view thereof;  
FIG. 12 is a second side view thereof;  
FIG. 13 is a front view thereof; and,  
FIG. 14 is a rear view thereof.

See application file for complete search history.

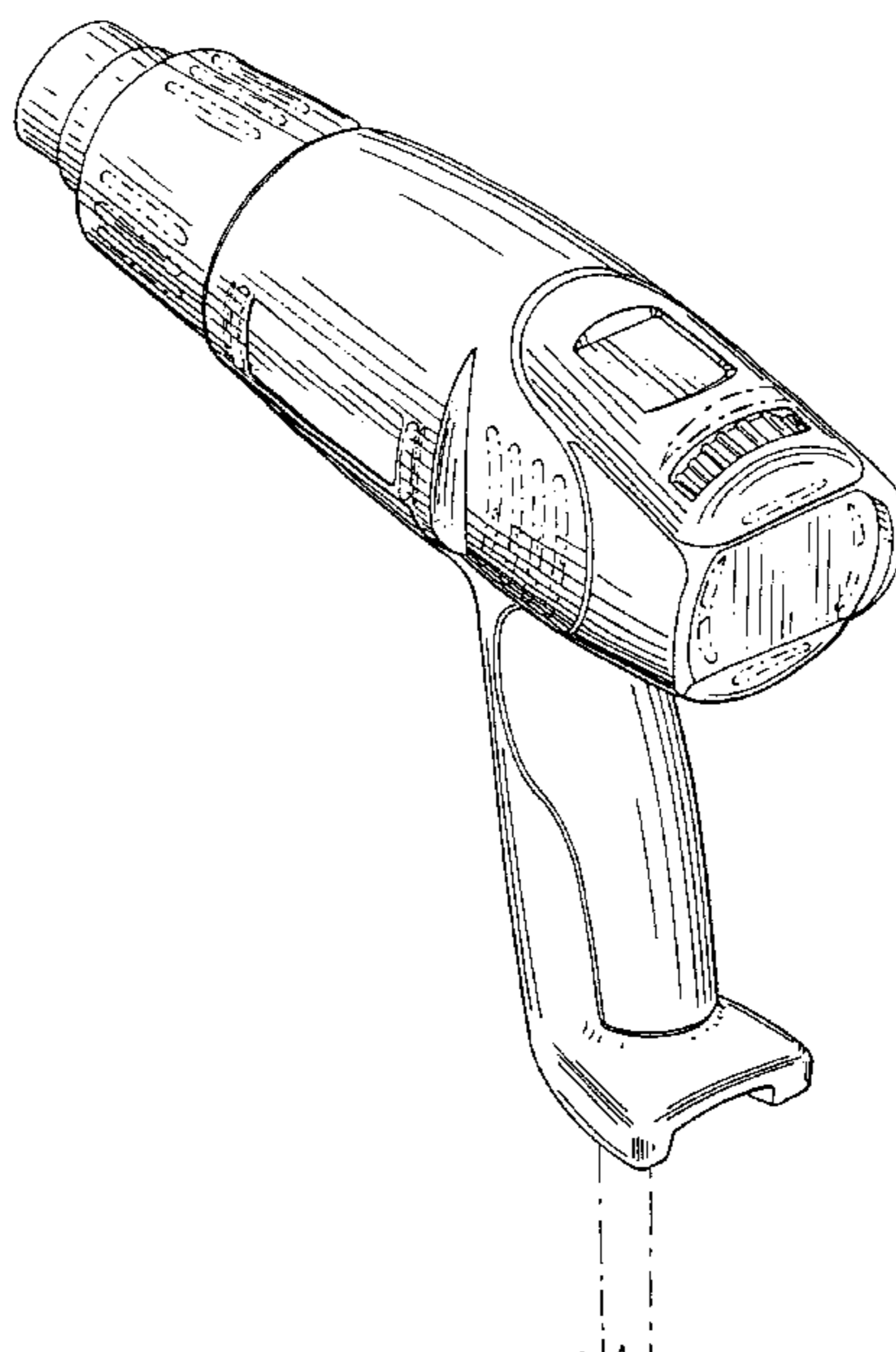
The ornamental design which is claimed is shown in solid lines in the drawings. Any broken lines in the drawings are for illustrative purposes only and form no part of the claimed design.

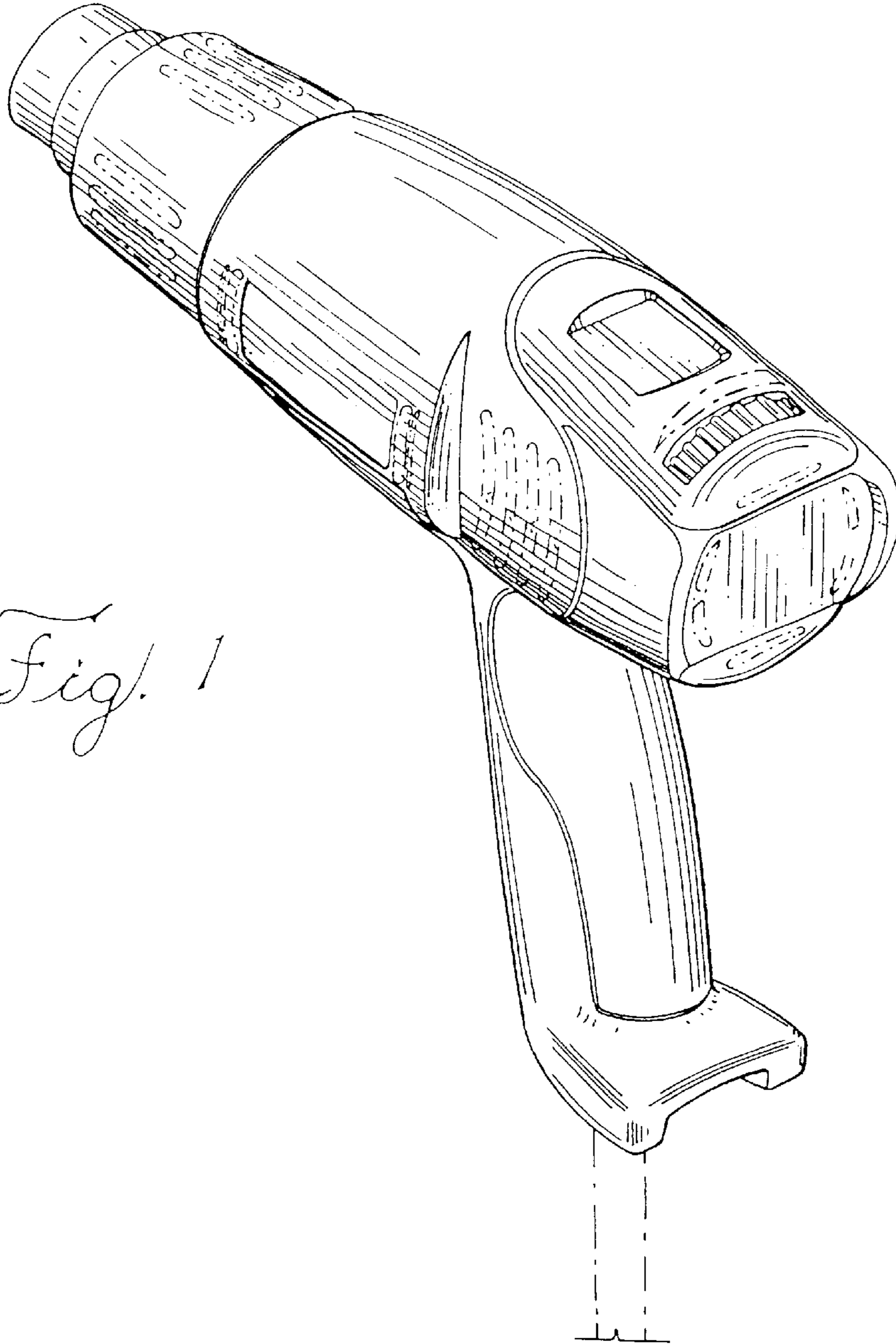
(56) **References Cited**

**U.S. PATENT DOCUMENTS**

1,716,580 A	6/1929	Duhamel	
2,201,506 A	5/1940	Smith	
2,267,547 A	12/1941	Zimmerman	
3,132,232 A	5/1964	Freedman et al.	
3,668,370 A	6/1972	Pattison	
3,986,272 A	10/1976	Feierabend	
D288,472 S	* 2/1987	Miller et al. ....	D23/332
D288,841 S	* 3/1987	Steinel et al. ....	D23/332
4,683,370 A	* 7/1987	Petersen et al. ....	392/385
D293,020 S	12/1987	Steinel et al.	
D296,070 S	* 6/1988	Cunningham ..... D8/29.1	
D297,397 S	* 8/1988	Pagani ..... D8/29.1	
4,904,847 A	2/1990	Kosaka et al.	
5,195,253 A	3/1993	Poumey et al.	
D334,876 S	* 4/1993	Swetish ..... D8/29.1	
D388,297 S	12/1997	Buttenbender	

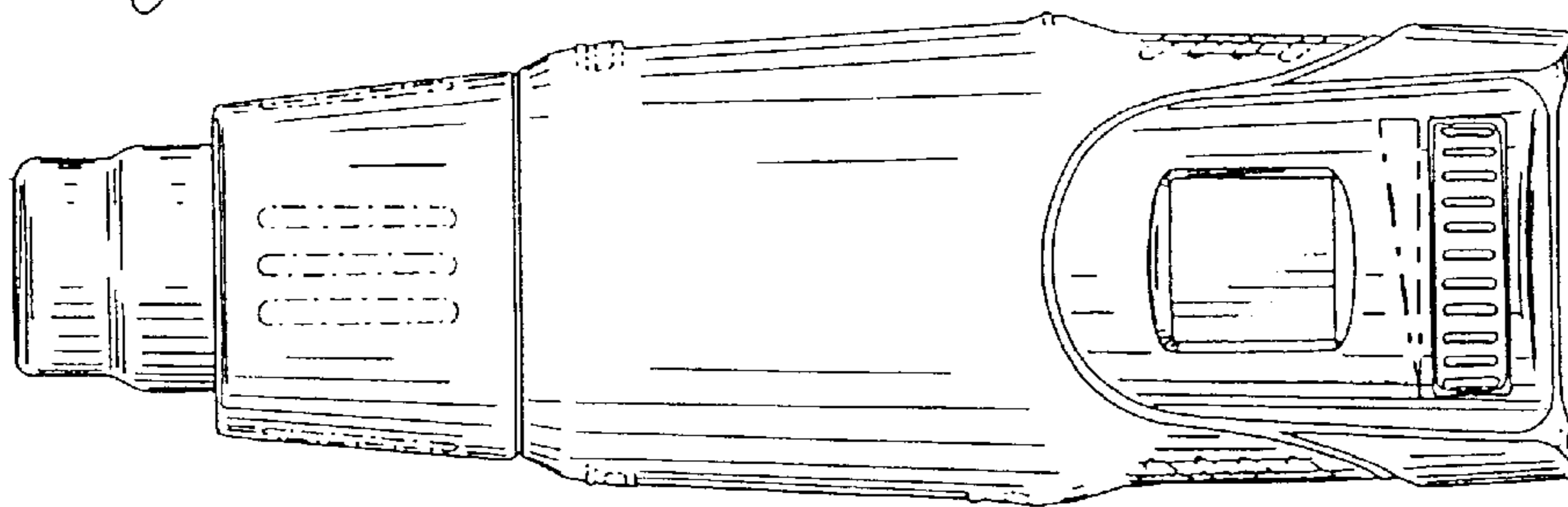
**1 Claim, 6 Drawing Sheets**

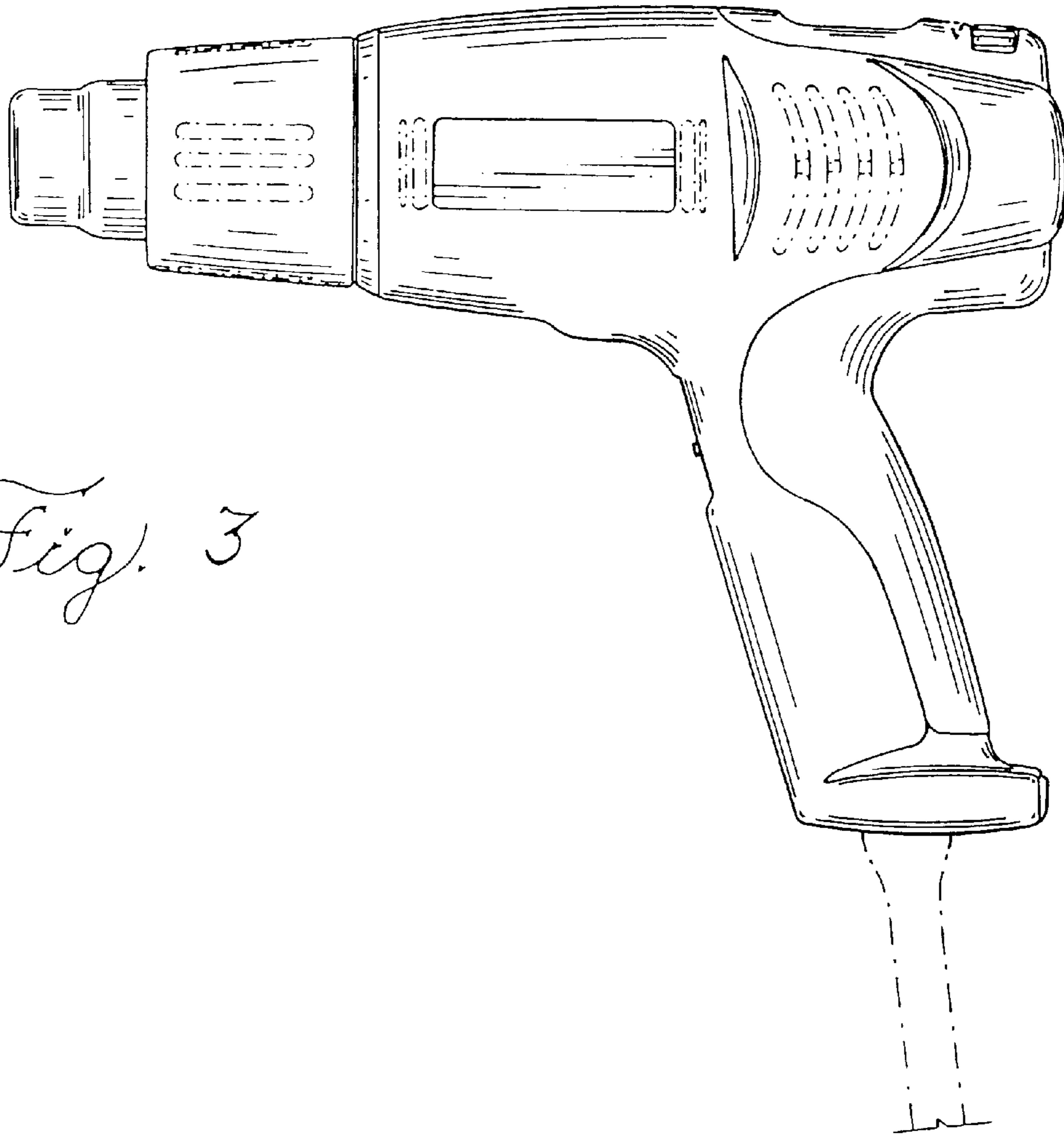




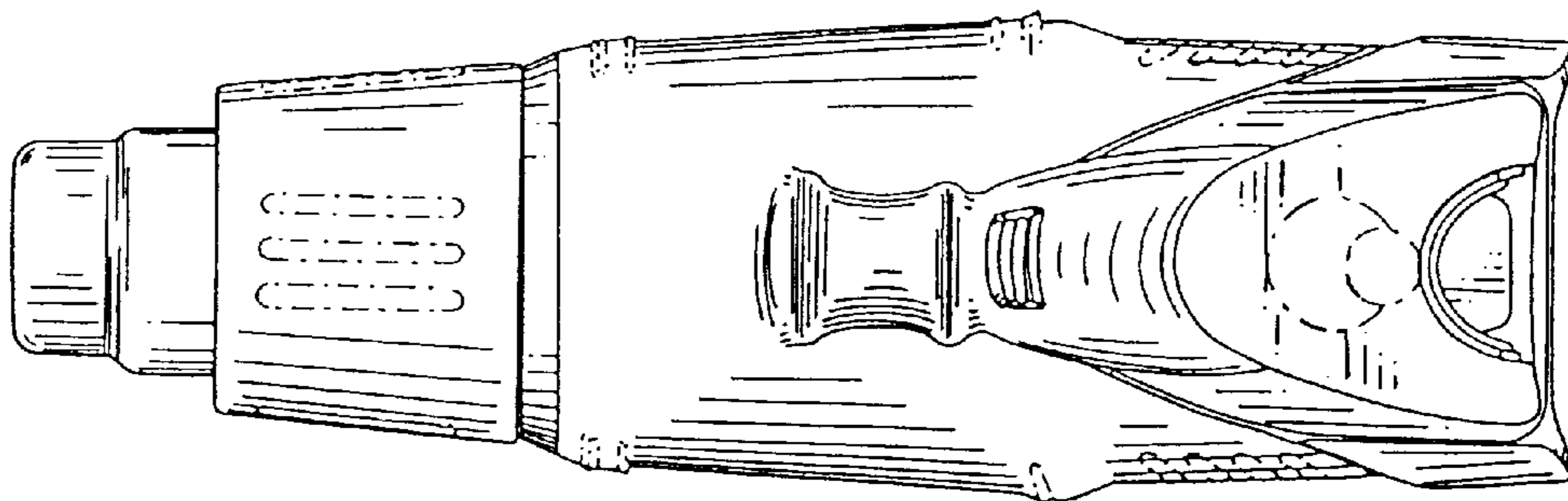
*Fig. 1*

*Fig. 2*

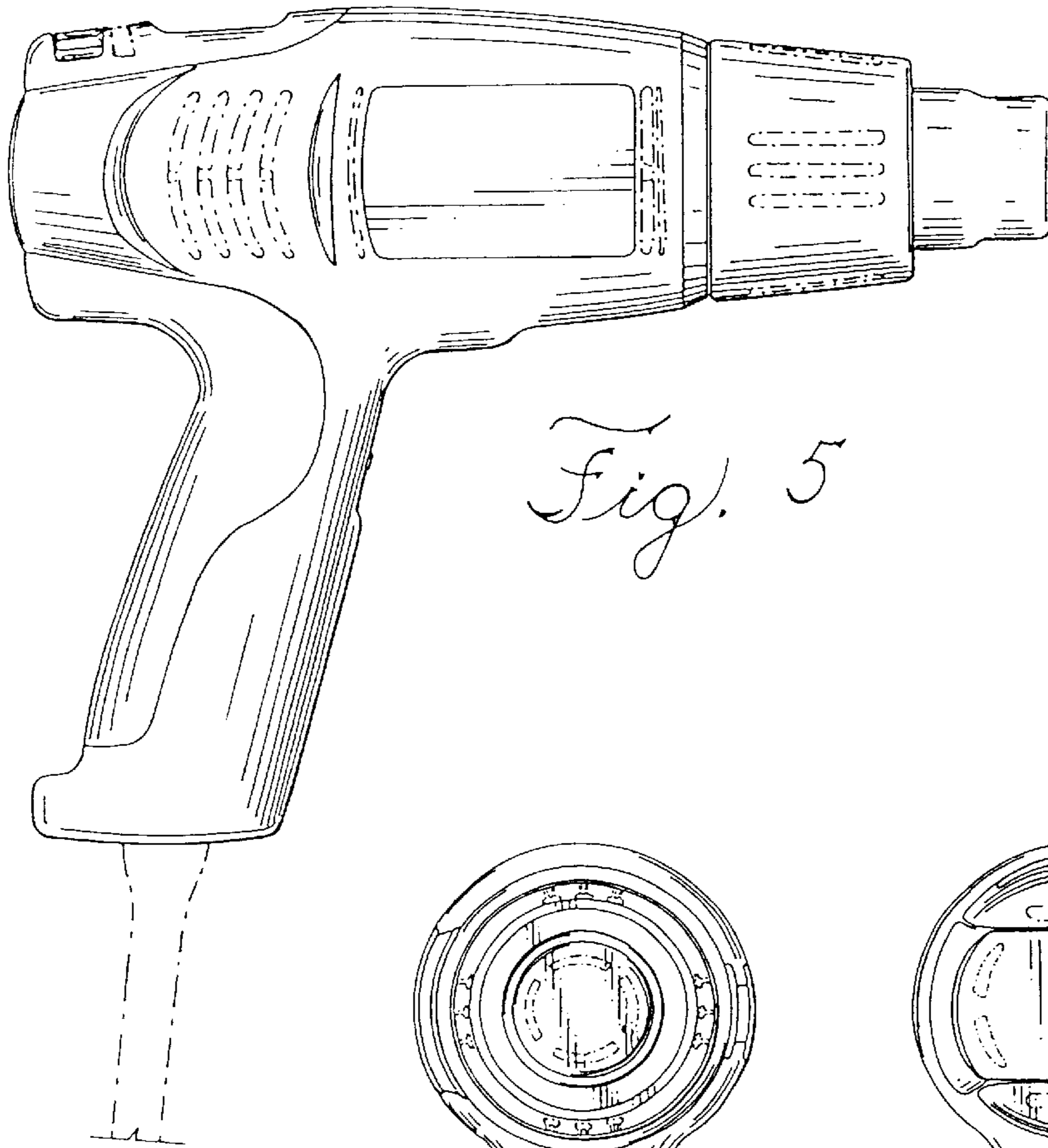




*Fig. 3*



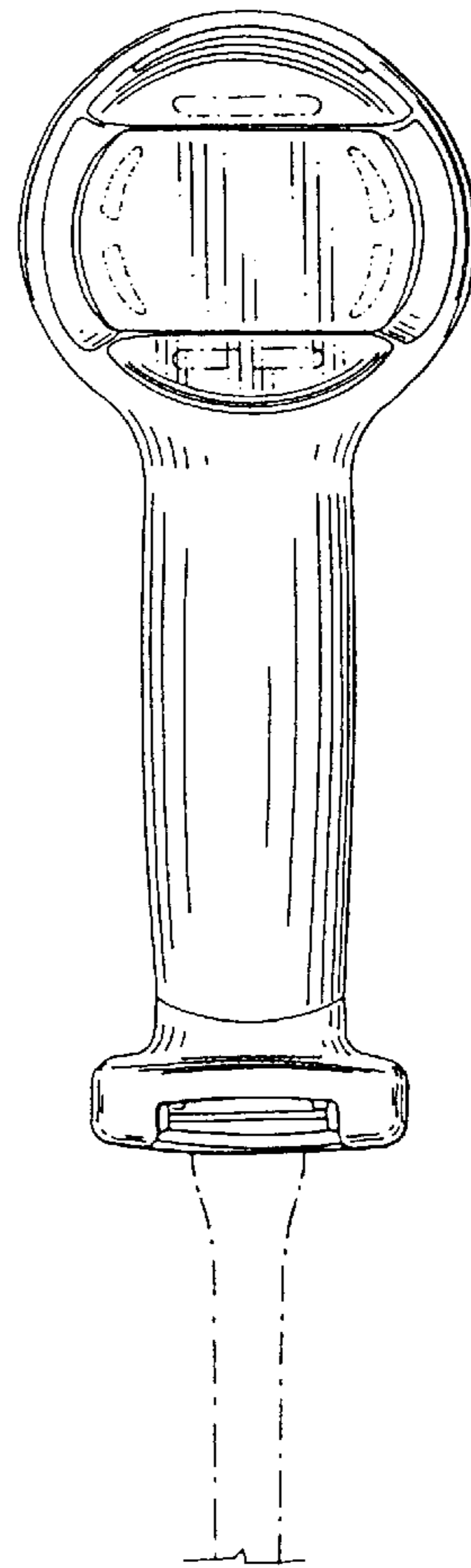
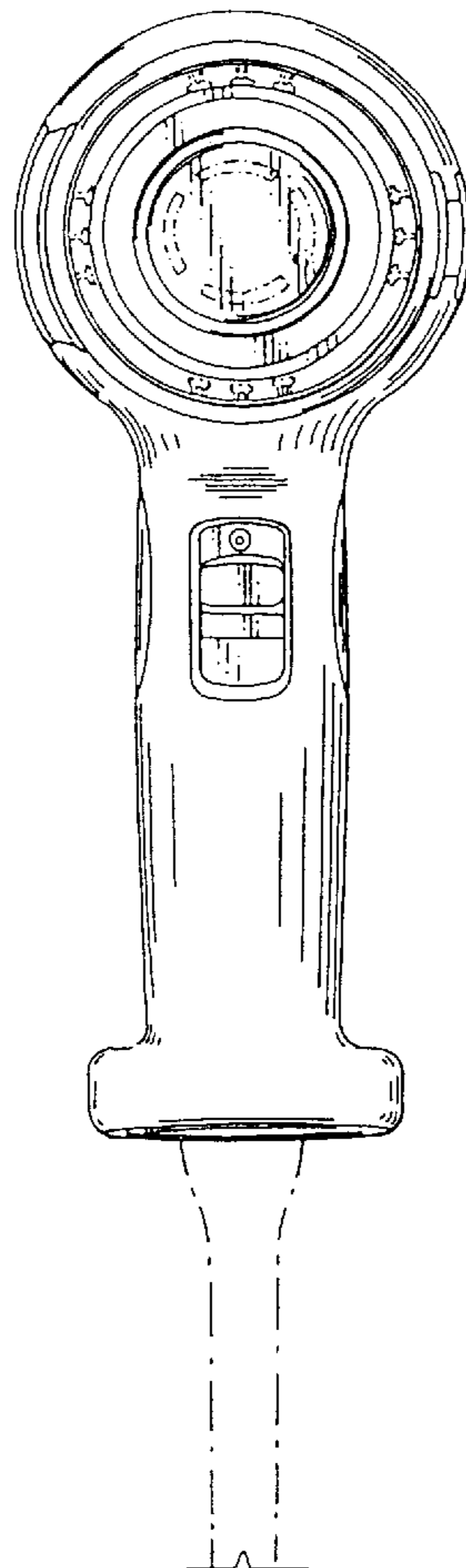
*Fig. 4*



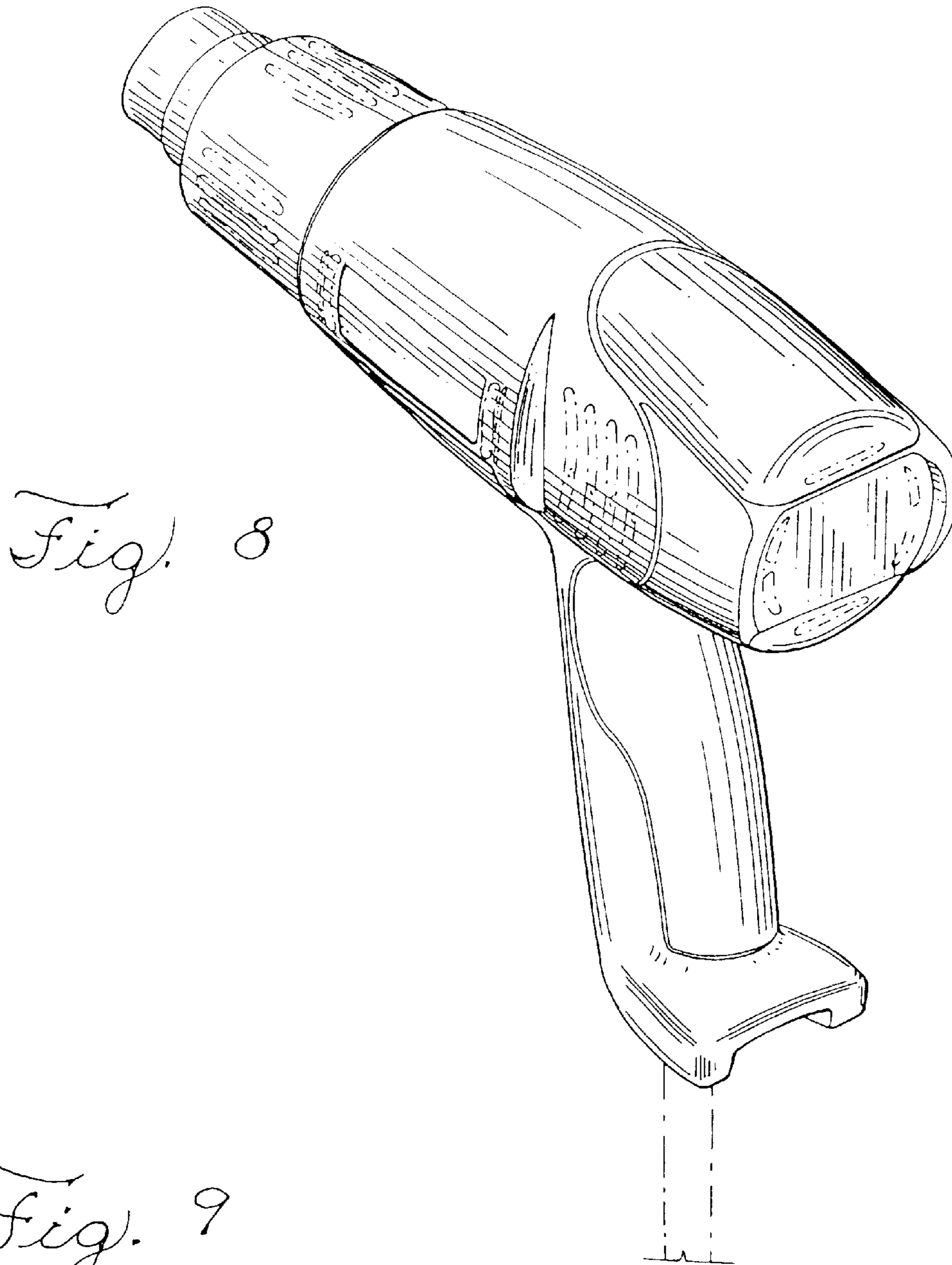
*Fig. 5*

*Fig. 7*

*Fig. 6*

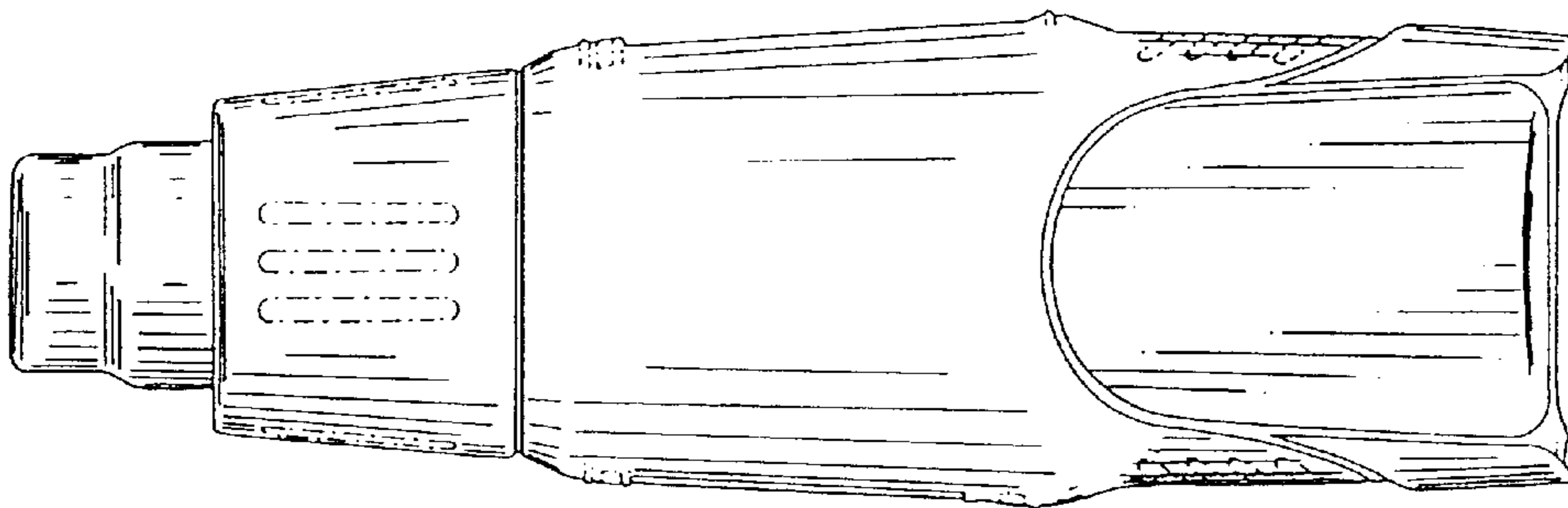


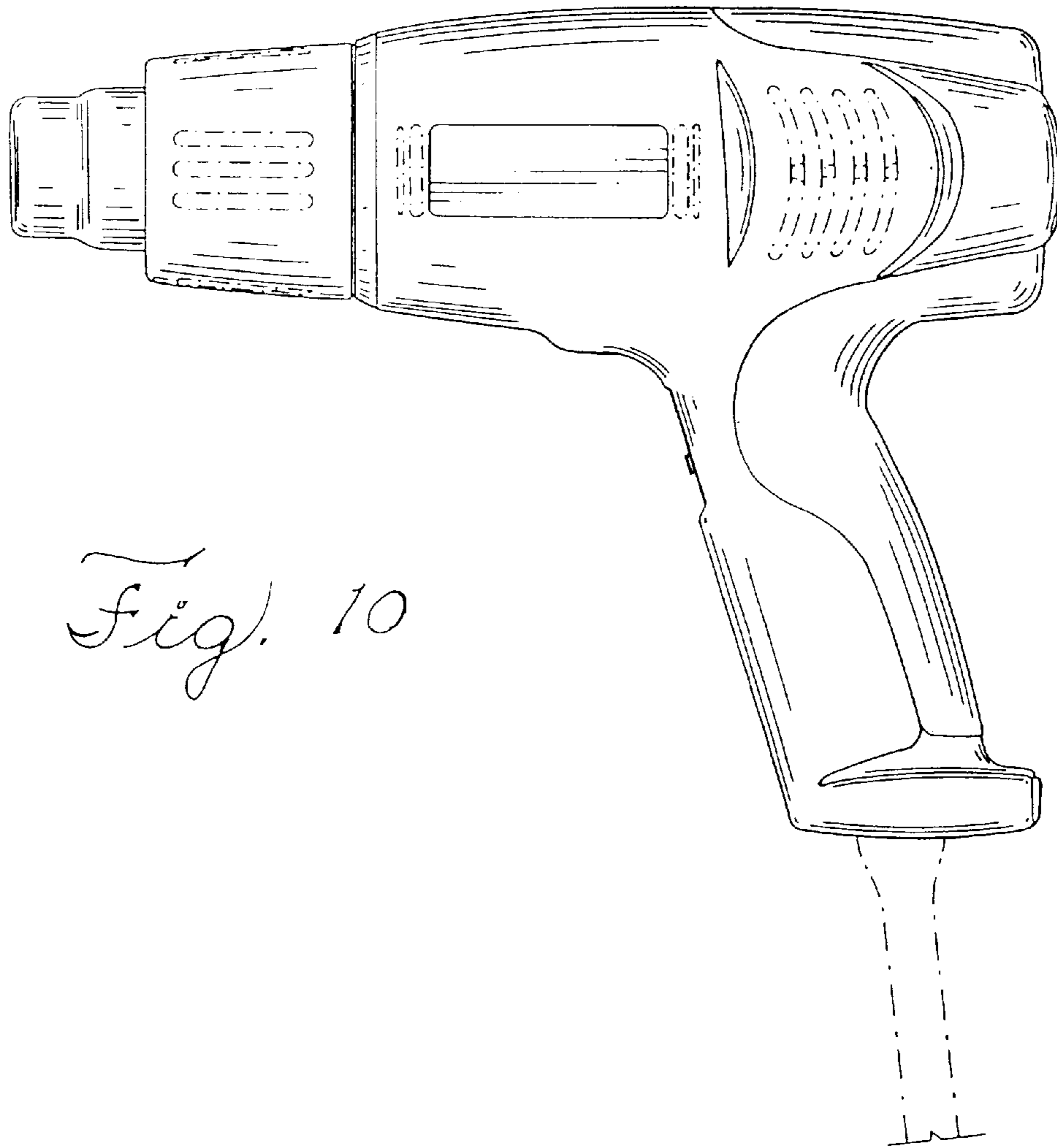




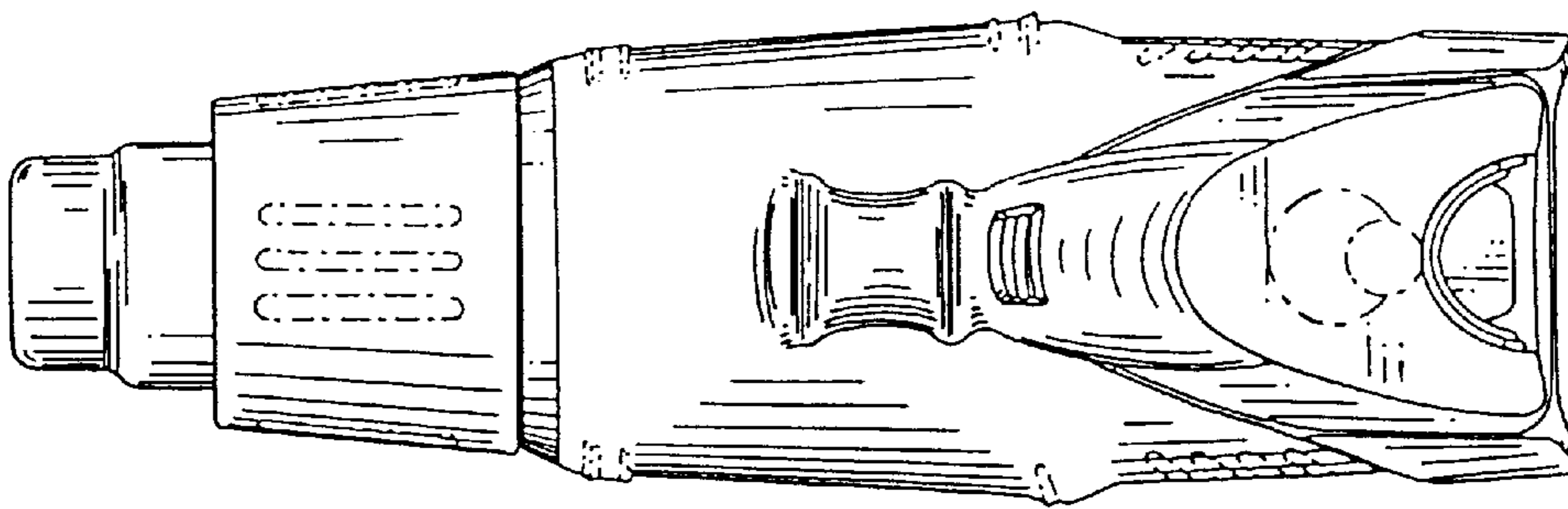
*Fig. 8*

*Fig. 9*

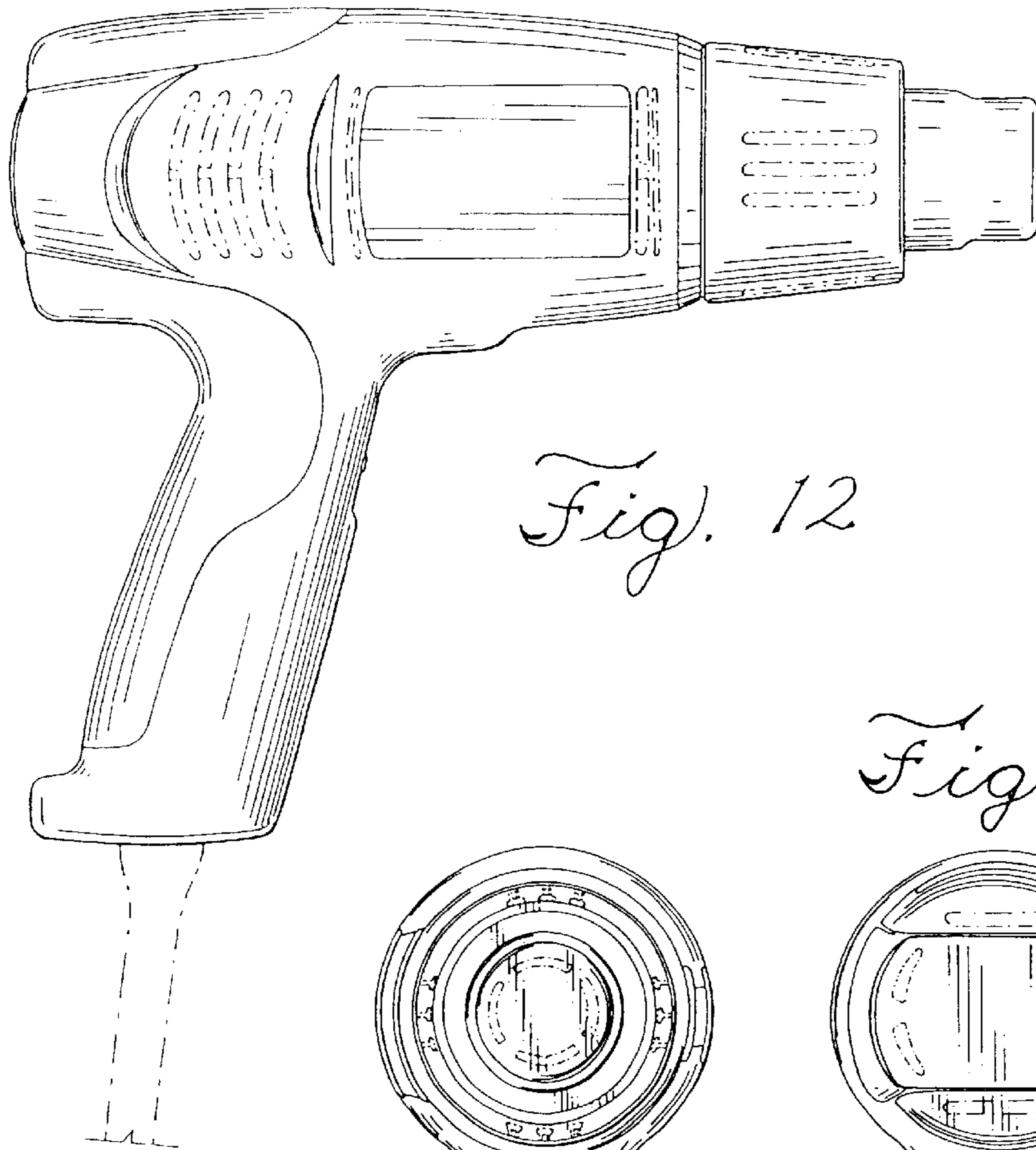




*Fig. 10*

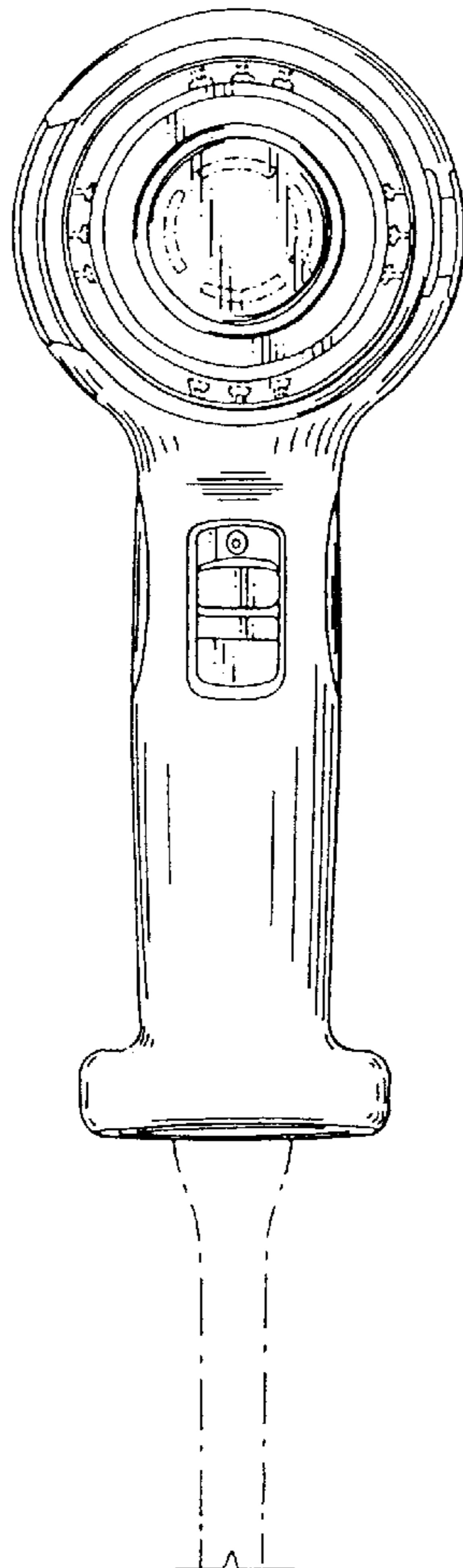


*Fig. 11*



*Fig. 12*

*Fig. 14*



*Fig. 13*

