



US00D516857S

(12) **United States Design Patent**
Kim

(10) **Patent No.:** **US D516,857 S**
(45) **Date of Patent:** **** Mar. 14, 2006**

(54) **CAVITY FOR MICROWAVE OVEN**

(75) **Inventor:** **Jae Hoon Kim, Seoul (KR)**

(73) **Assignee:** **LG Electronics Inc., Seoul (KR)**

(**) **Term:** **14 Years**

(21) **Appl. No.:** **29/222,005**

(22) **Filed:** **Jan. 26, 2005**

(30) **Foreign Application Priority Data**

Oct. 26, 2004 (KR) 30-2004-0032755

(51) **LOC (8) Cl.** **07-02**

(52) **U.S. Cl.** **D7/351**

(58) **Field of Classification Search** D7/350.1,
D7/350.3, 350.4, 351, 402, 405; 219/756-758,
219/378, 752, 19 M, 275 E; 99/DIG. 14
See application file for complete search history.

(56) **References Cited**

U.S. PATENT DOCUMENTS

D352,866 S * 11/1994 Kindley et al. D7/351
D431,416 S * 10/2000 Holbrook D7/402

6,384,392 B1 * 5/2002 Lee et al. 219/756
D465,964 S * 11/2002 Morgan D7/351
D477,964 S * 8/2003 Kanza D7/351

* cited by examiner

Primary Examiner—Ruth McInroy

(74) *Attorney, Agent, or Firm*—Birch, Stewart, Kolasch & Birch, LLP

(57) **CLAIM**

I claim the ornamental design for a cavity for microwave oven, as shown and described.

DESCRIPTION

FIG. 1 is a perspective view of a cavity for microwave oven showing my new design;
FIG. 2 is a front elevation view thereof;
FIG. 3 is a rear elevation view thereof;
FIG. 4 is a left-side elevation view thereof;
FIG. 5 is a right-side elevation view thereof;
FIG. 6 is a top plan view thereof;
FIG. 7 is a bottom plan view thereof; and,
FIG. 8 is a sectional view taken along line 8—8 in FIG. 2.

1 Claim, 5 Drawing Sheets

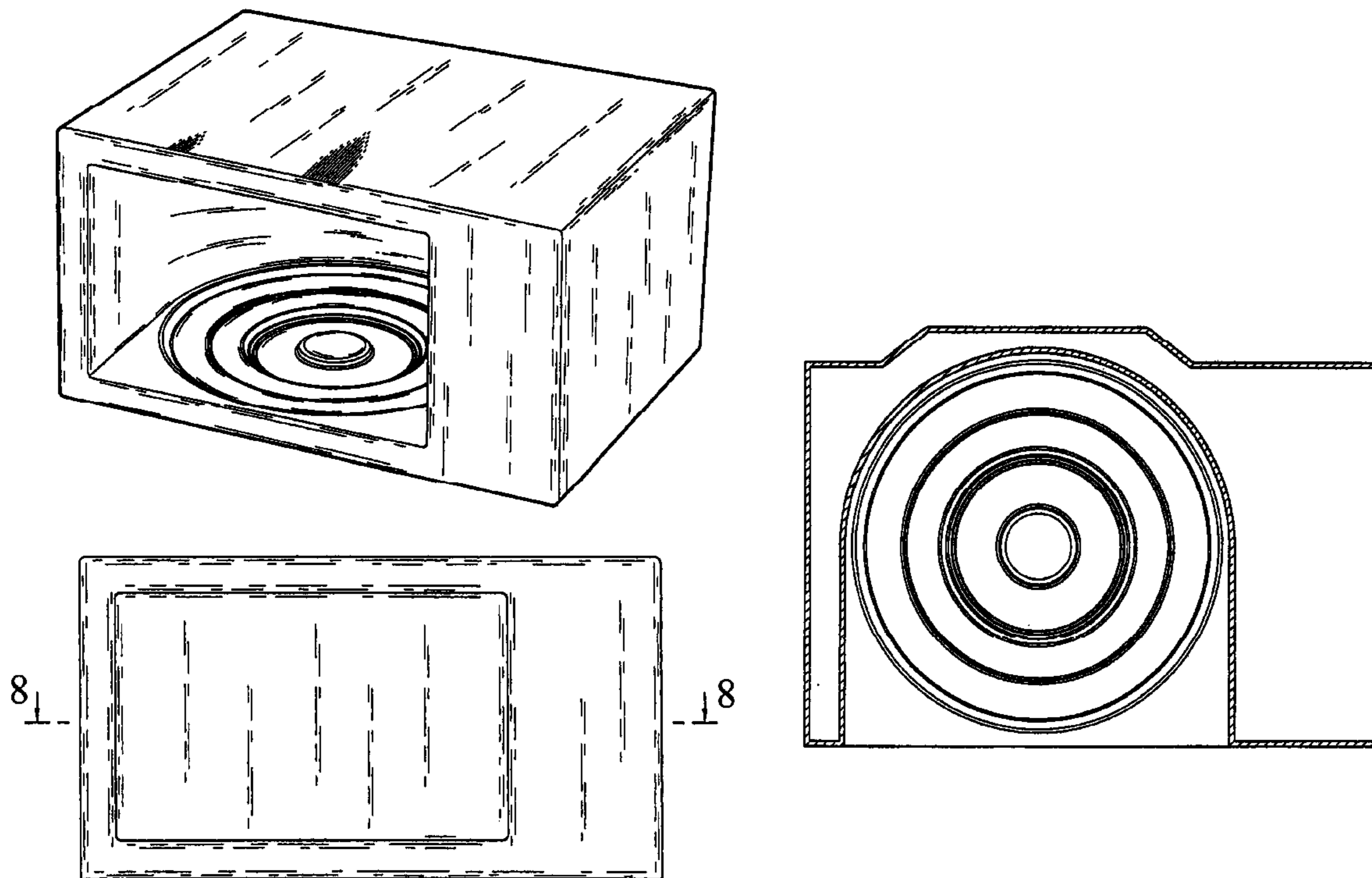

FIG. 1

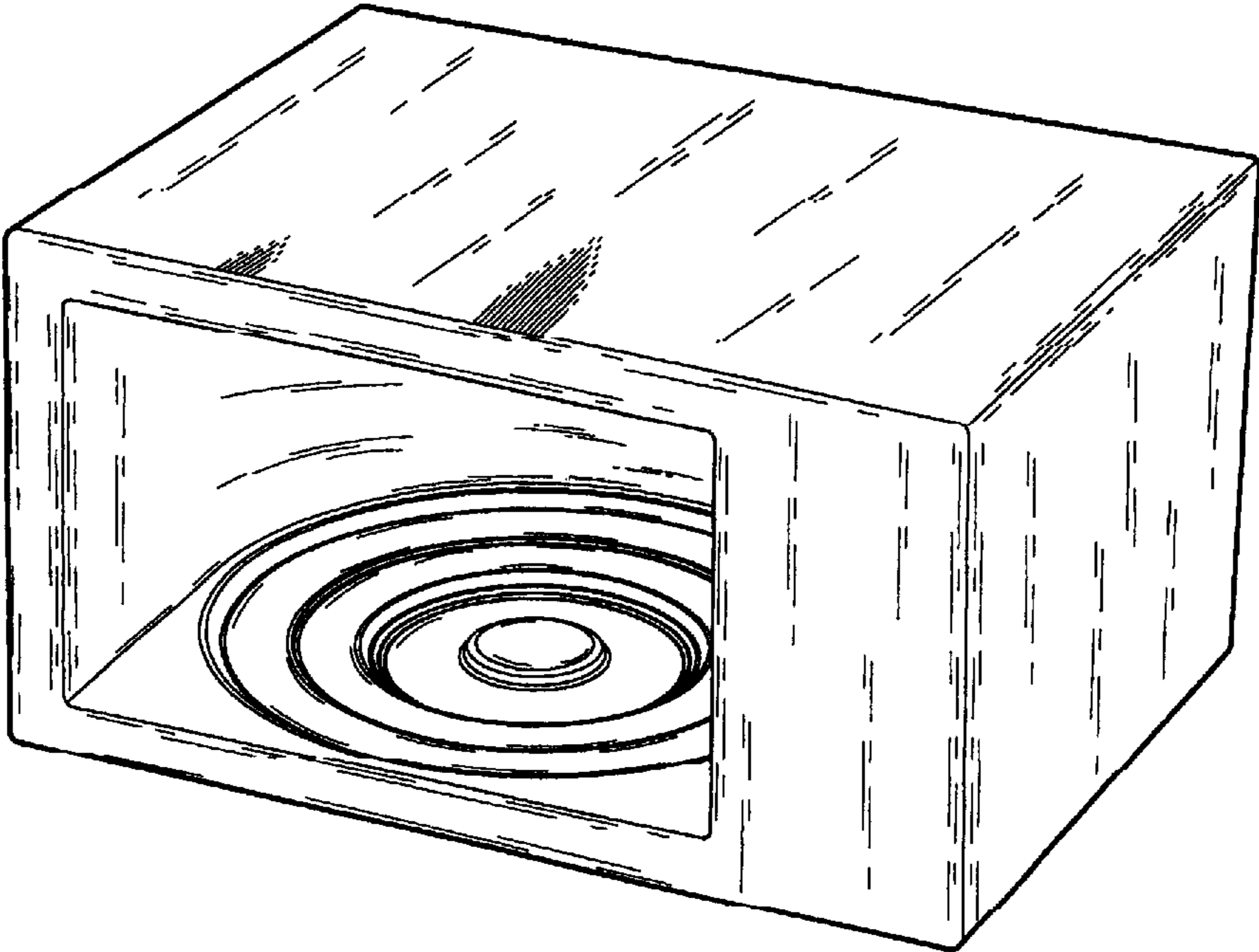

FIG. 2

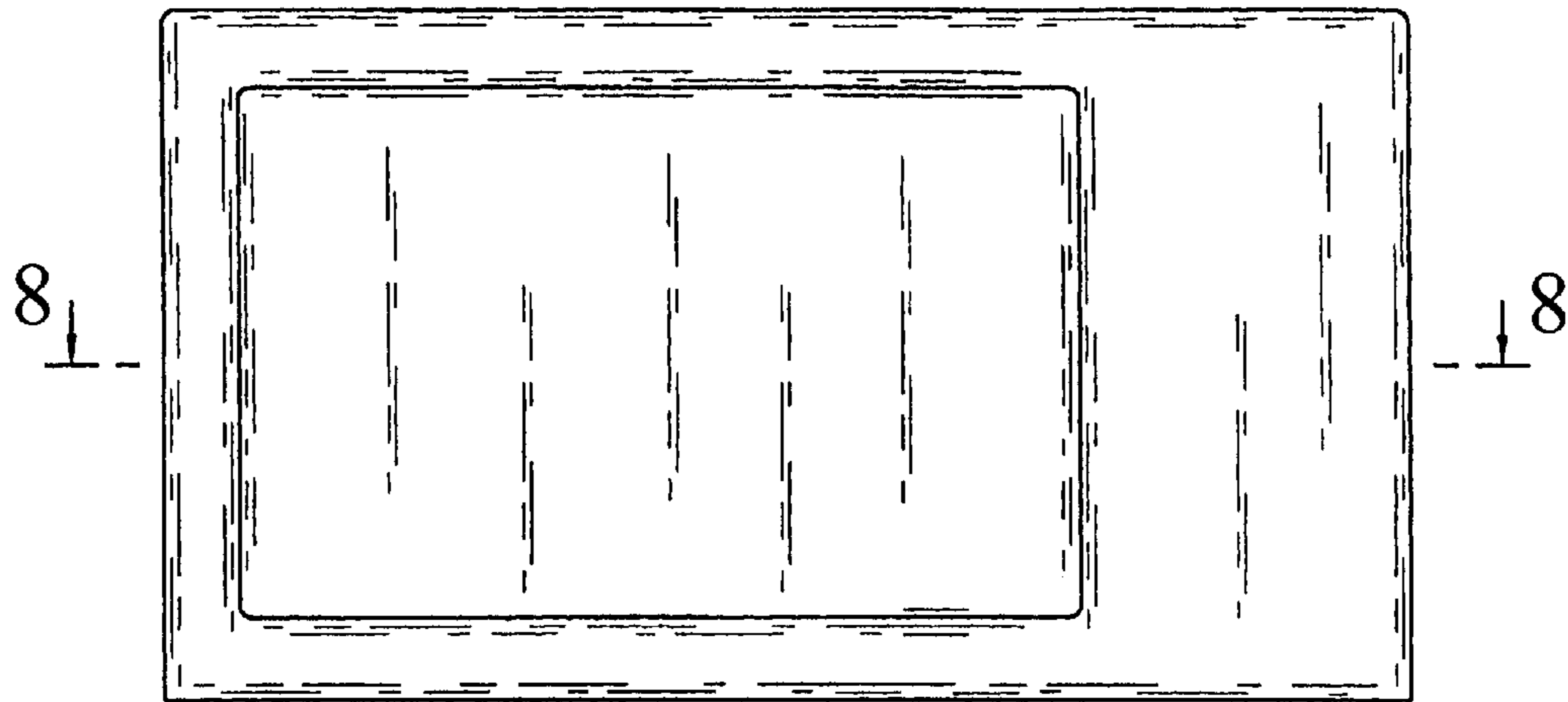

FIG. 3

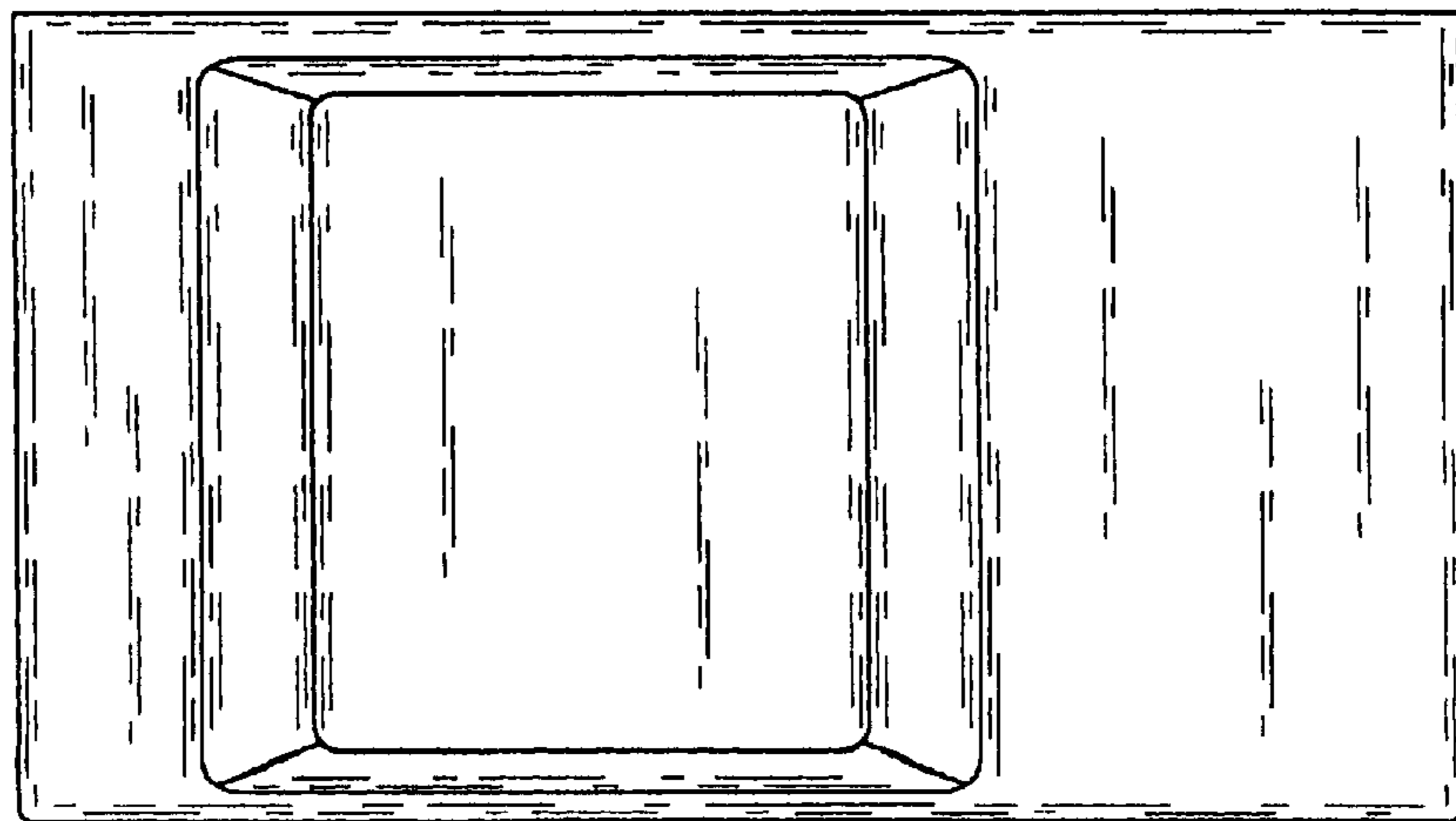

FIG. 4

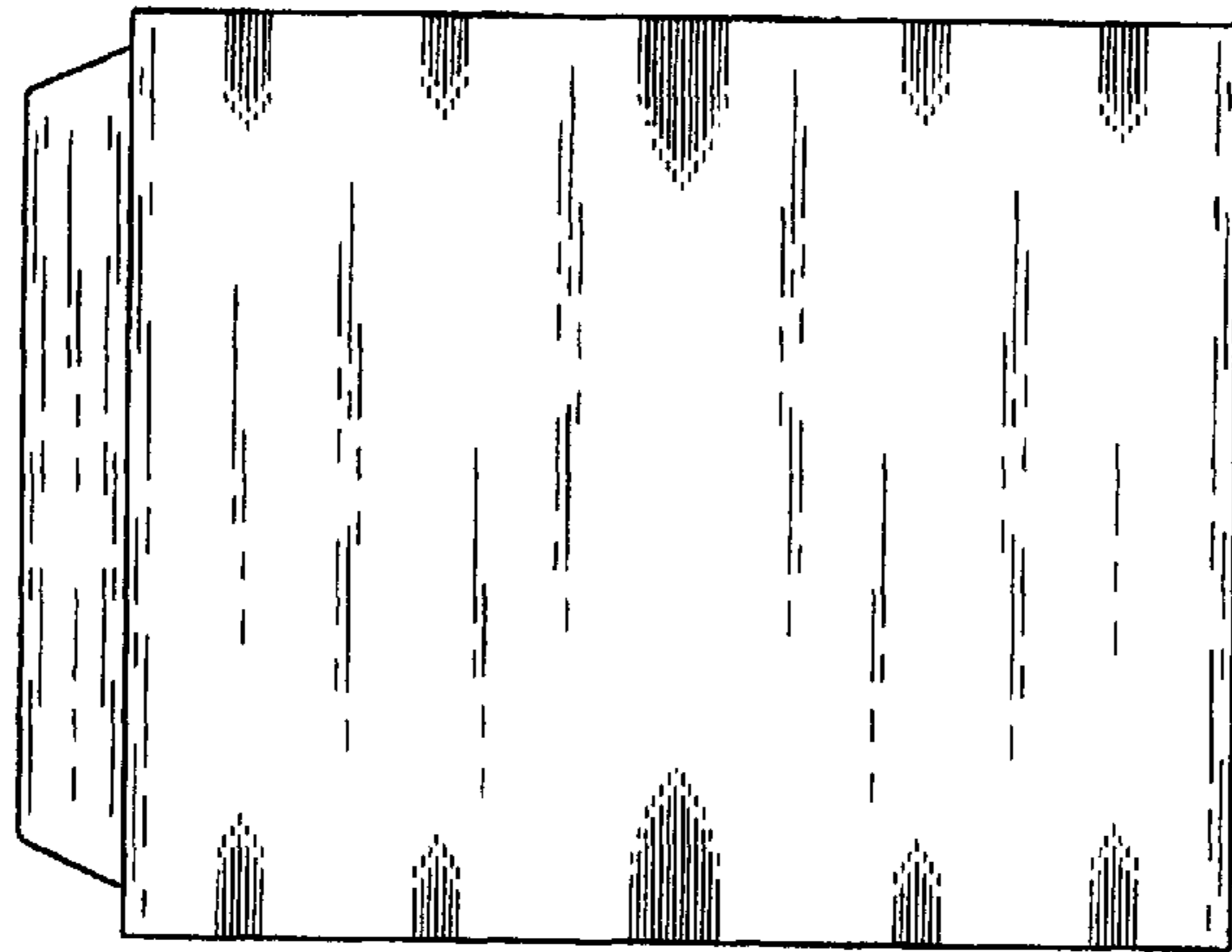

FIG. 5

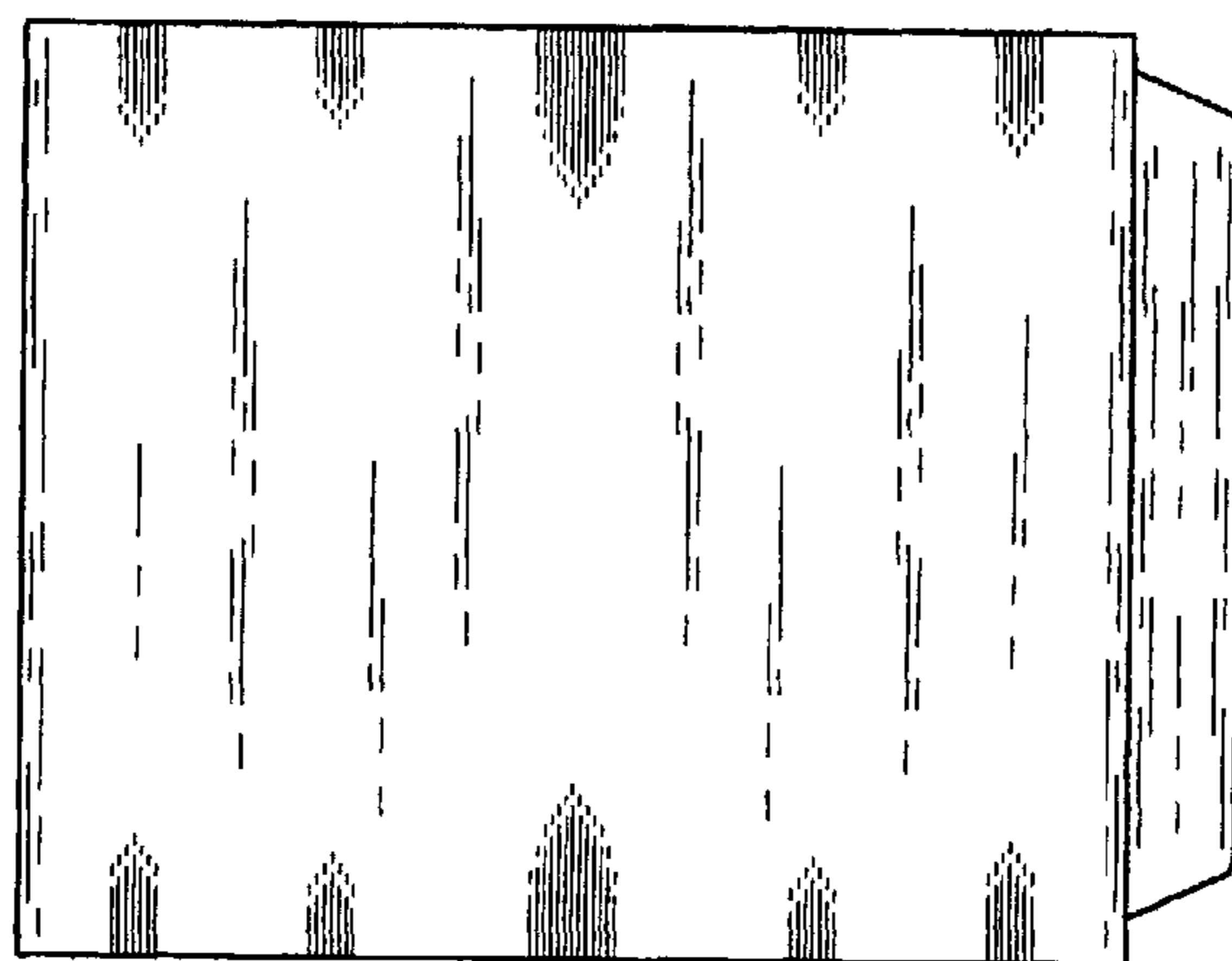

FIG. 6

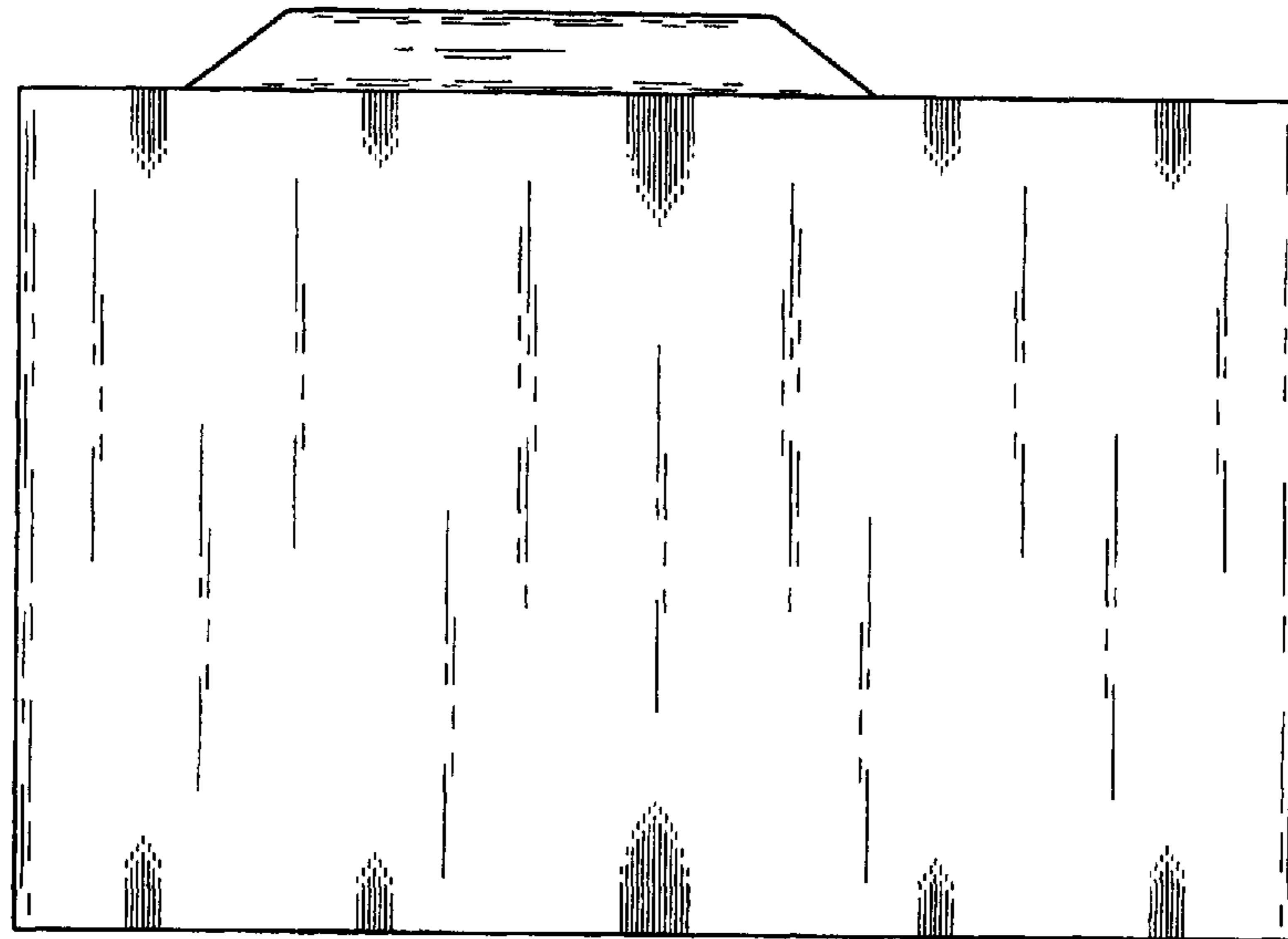

FIG. 7

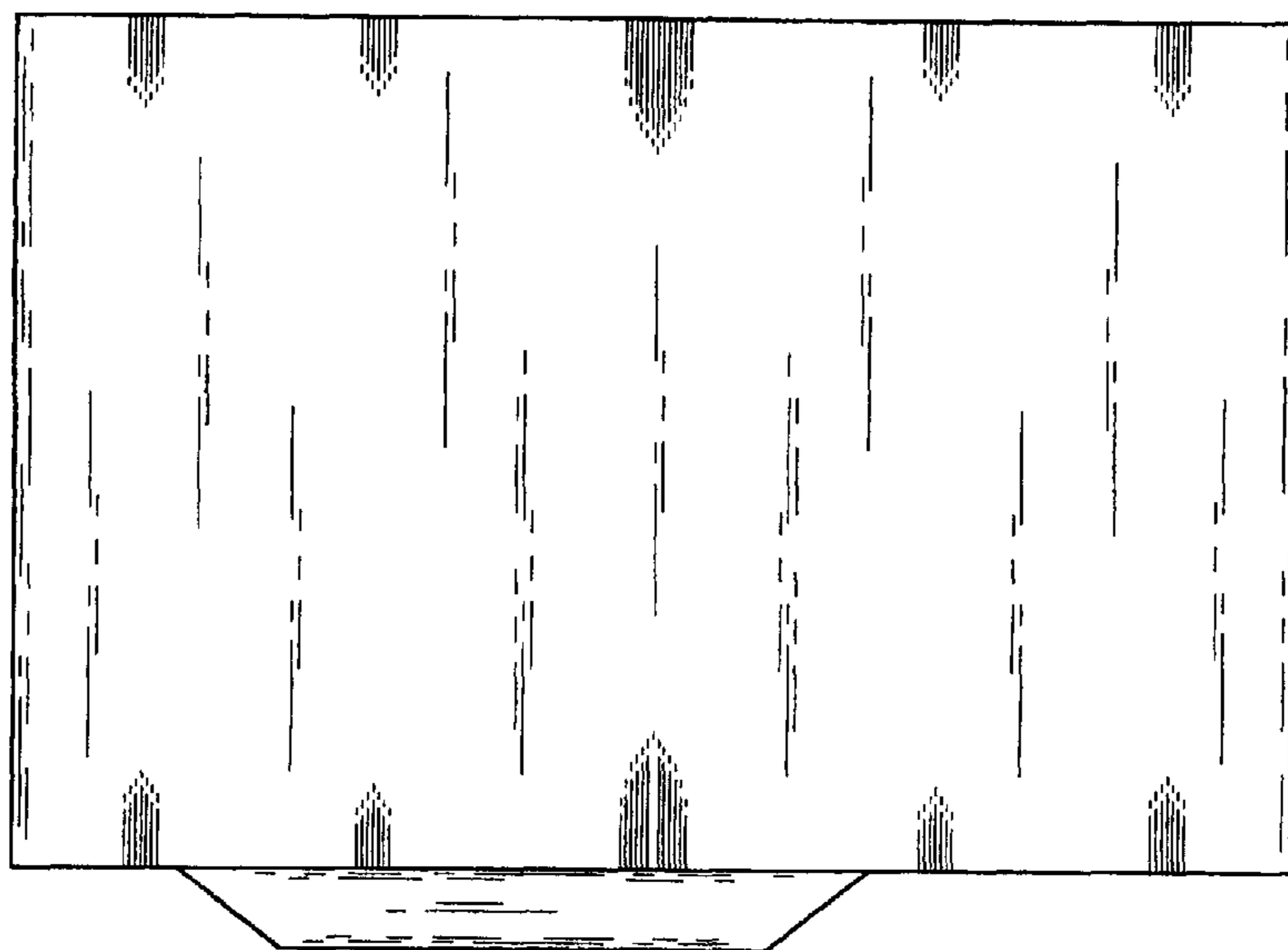

FIG. 8

