



US00D516721S

(12) **United States Design Patent**
Py et al.

(10) **Patent No.:** **US D516,721 S**
(45) **Date of Patent:** **** Mar. 7, 2006**

(54) **DISPENSER**
(75) Inventors: **Daniel Py**, Stamford, CT (US); **Julian V. Chan**, Spring Valley, NY (US); **Norbert M. Assion**, Shelton, CT (US)

(73) Assignee: **Medical Instill Technologies, Inc.**,
New Milford, CT (US)

(**) Term: **14 Years**

(21) Appl. No.: **29/212,959**

(22) Filed: **Sep. 10, 2004**

Related U.S. Application Data

(62) Division of application No. 29/175,061, filed on Jan. 28, 2003, now Pat. No. Des. 495,946.

(51) **LOC (8) Cl.** **24-02**

(52) **U.S. Cl.** **D24/150; D9/448; D9/685**

(58) **Field of Classification Search** D9/443,
D9/447, 448, 449, 530, 531, 532, 682, 683,
D9/685, 704, 753, 504, 684, 687, 688, 689,
D9/724; D24/113, 120, 150; D23/223, 226;
222/153.07, 182, 130, 383.1, 380, 321.8,
222/402.13, 472, 556, 558, 94, 192; D8/88;
239/288.5, 304; D28/7, 91.1; 604/294, 295

See application file for complete search history.

(56) **References Cited**

U.S. PATENT DOCUMENTS

- D44,414 S * 7/1913 Schaefer D8/88
- 1,471,091 A 10/1923 Bessesen
- 3,168,226 A * 2/1965 Underwood et al. 222/472
- 3,820,721 A * 6/1974 Hellenkamp 239/288.5
- 3,921,333 A 11/1975 Clendinning et al.
- 3,993,069 A 11/1976 Buckles et al.
- 4,023,607 A 5/1977 Jensen et al.
- 4,233,262 A 11/1980 Curto
- 4,240,465 A 12/1980 Rader
- 4,264,018 A 4/1981 Warren
- 4,479,989 A 10/1984 Mahal
- 4,482,585 A 11/1984 Ohodaira et al.

- 4,501,781 A 2/1985 Kushida et al.
- 4,578,295 A 3/1986 Jabarin
- 4,579,757 A 4/1986 Su et al.
- 4,603,066 A 7/1986 Jabarin
- 4,636,412 A 1/1987 Field

(Continued)

FOREIGN PATENT DOCUMENTS

EP 0802827 B1 8/1998

Primary Examiner—Paula A. Greene

(74) *Attorney, Agent, or Firm*—McCarter & English LLP

(57) **CLAIM**

The ornamental design for a dispenser, as shown and described.

DESCRIPTION

FIG. 1 is a perspective view of a first embodiment of a dispenser showing our new design; FIG. 2 is a front elevational view of the dispenser of FIG. 1; FIG. 3 is a left side elevational view thereof; FIG. 4 is a rear elevational view thereof; FIG. 5 is a top plan view thereof; FIG. 6 is a bottom plan view thereof; and FIG. 7 is a right side elevational view thereof. FIG. 8 is a perspective view of a second embodiment of a dispenser showing our new design; FIG. 9 is a front elevational view of the dispenser of FIG. 8; FIG. 10 is a left side elevational view thereof; FIG. 11 is a rear elevational view thereof; FIG. 12 is a top plan view thereof; FIG. 13 is a bottom plan view thereof; and, FIG. 14 is a right side elevational view thereof.

The broken lines shown in the figures show structure that is not part of the claimed design, but rather show the environment in which the design is associated, or show portions of the article in which the design is embodied or applied to that are not considered part of the claimed design.

The broken lines in FIGS. 1 through 14 are for illustrative purposes only and forms no part of the claimed design.

1 Claim, 8 Drawing Sheets

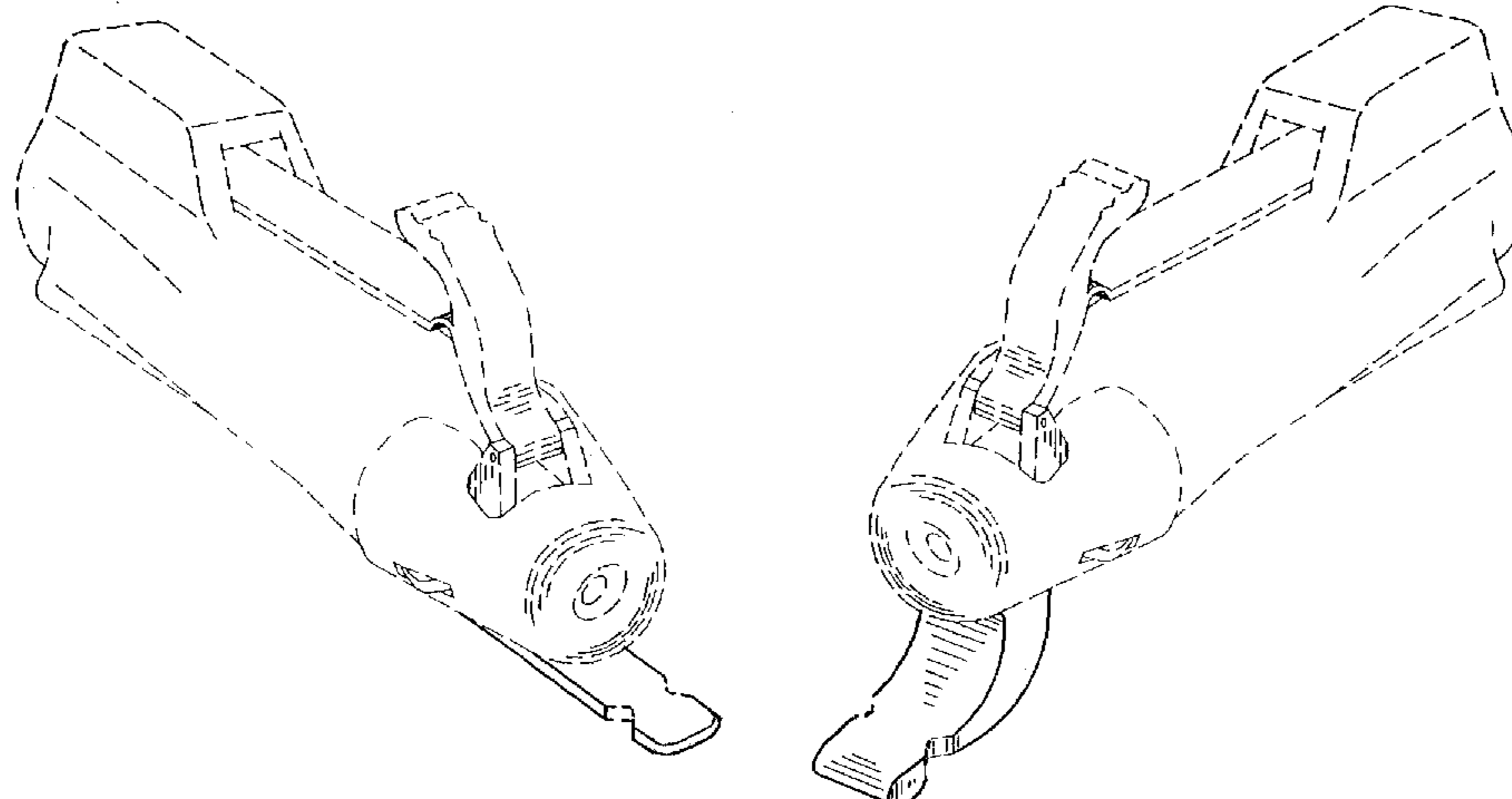

US D516,721 S

Page 2

U.S. PATENT DOCUMENTS					
4,700,838 A	10/1987	Falciani et al.	5,562,960 A	10/1996	Sugiura et al.
4,704,510 A	11/1987	Matsui	5,565,160 A	10/1996	Makuuchi et al.
4,784,652 A	11/1988	Wikström	5,613,957 A	3/1997	Py
4,854,481 A	8/1989	Bohl et al.	5,615,795 A	4/1997	Tipps
4,859,513 A	8/1989	Gibbons et al.	5,641,004 A	6/1997	Py
4,880,675 A	11/1989	Mehta	5,676,267 A	10/1997	Slat et al.
4,910,147 A	3/1990	Bacehowski et al.	5,685,869 A	11/1997	Py
4,921,733 A	5/1990	Gibbons et al.	5,687,882 A	11/1997	Mueller
D310,957 S	* 10/1990	Halm et al. D9/685	5,746,728 A	5/1998	Py
4,971,227 A	* 11/1990	Knickerbocker et al. 222/153.07	5,780,130 A	7/1998	Hansen et al.
4,981,479 A	1/1991	Py	5,803,311 A	9/1998	Fuchs
5,102,705 A	4/1992	Yammoto et al.	5,804,236 A	9/1998	Frisk
5,238,153 A	8/1993	Castillo et al.	5,816,772 A	10/1998	Py
5,263,946 A	11/1993	Klug	5,839,616 A	* 11/1998	Irwin et al. 222/321.8
5,267,986 A	12/1993	Py	D404,305 S	* 1/1999	De Baschmakoff D9/449
5,320,845 A	6/1994	Py	5,875,931 A	3/1999	Py
5,366,108 A	11/1994	Darling	5,931,386 A	8/1999	Jouillat
5,401,259 A	3/1995	Py	5,944,702 A	8/1999	Py
5,419,465 A	5/1995	Schroeder	RE36,410 E	11/1999	Meshberg
5,429,254 A	7/1995	Christine	6,033,384 A	3/2000	Py
RE35,187 E	3/1996	Gortz	6,062,430 A	5/2000	Fuchs
D368,774 S	4/1996	Py	D447,415 S	* 9/2001	Spengler D9/448
5,529,216 A	* 6/1996	Klima et al. 222/130	6,343,713 B1	2/2002	Abplanalp
D374,719 S	10/1996	Py	D485,489 S	* 1/2004	Kadlubowski et al. D9/688
			D495,946 S	* 9/2004	Py et al. D24/150

* cited by examiner

FIG. 1

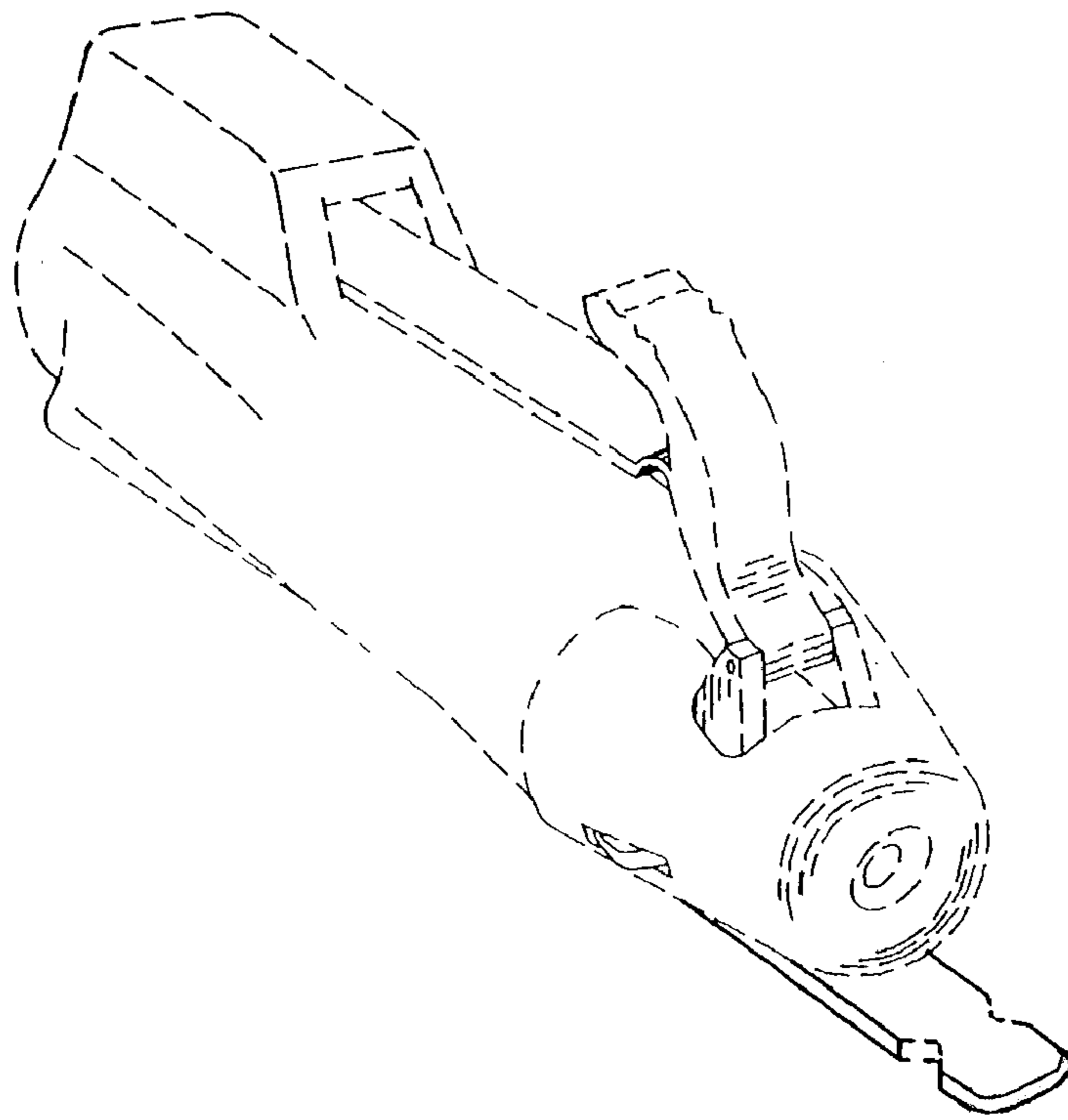

FIG. 2

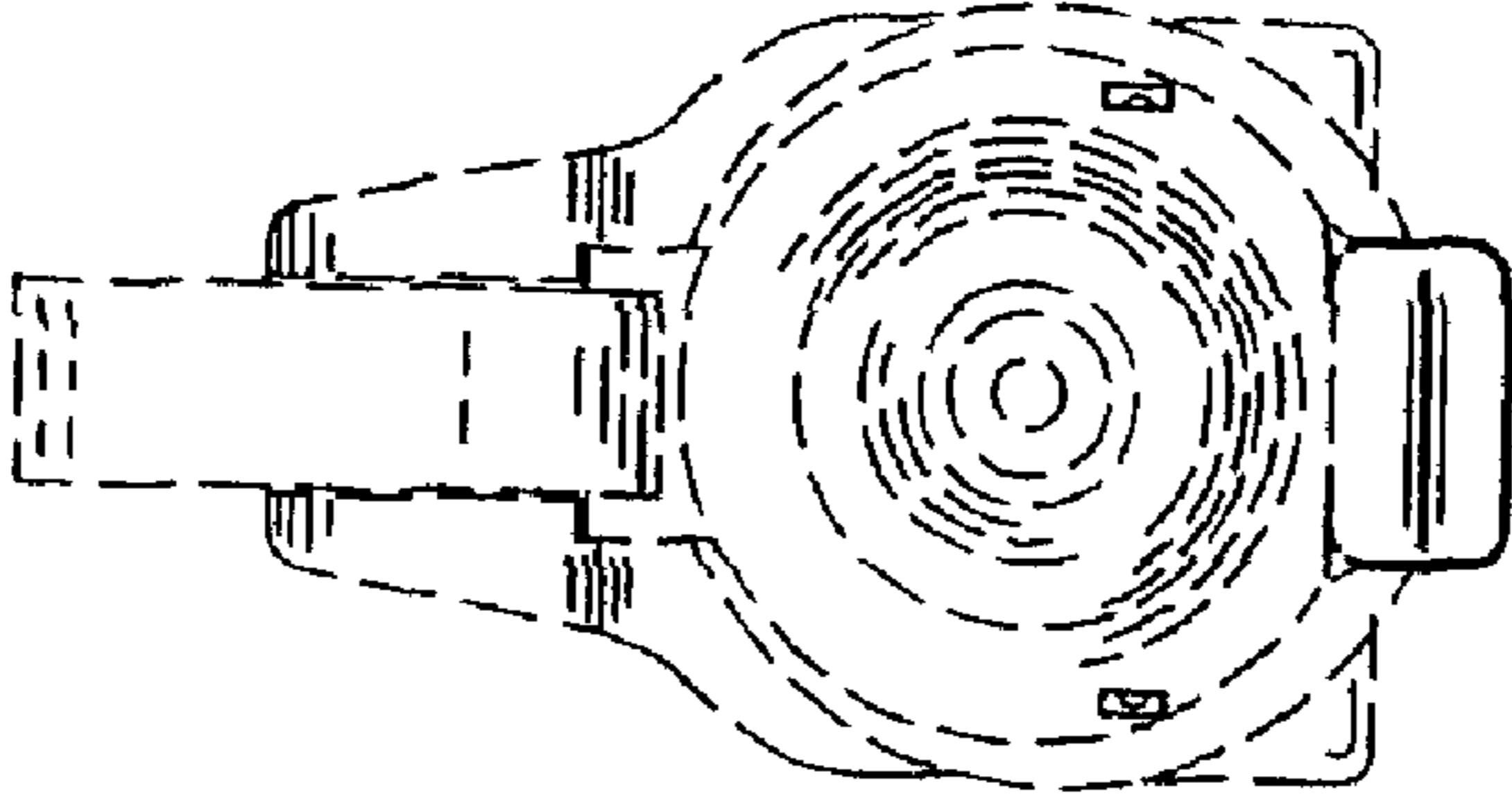

FIG. 3

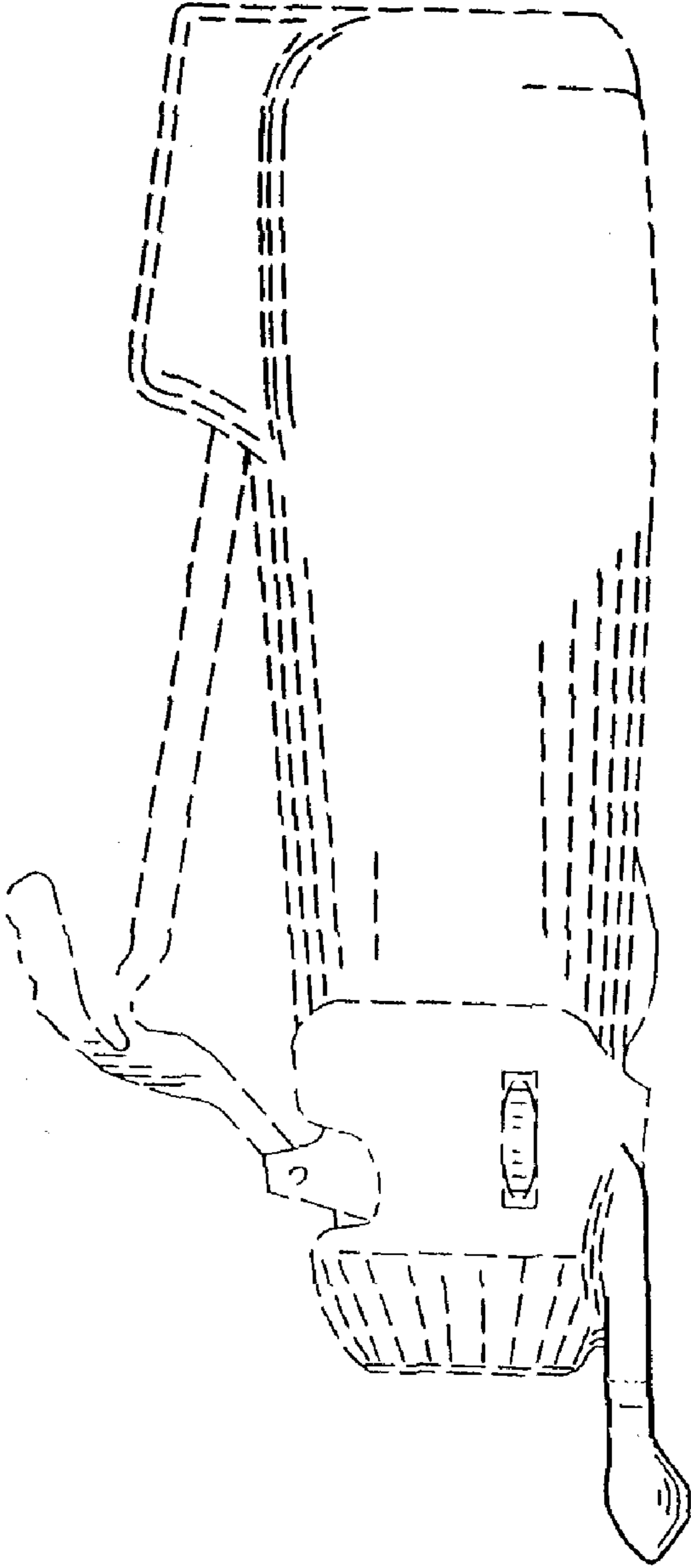

FIG. 5

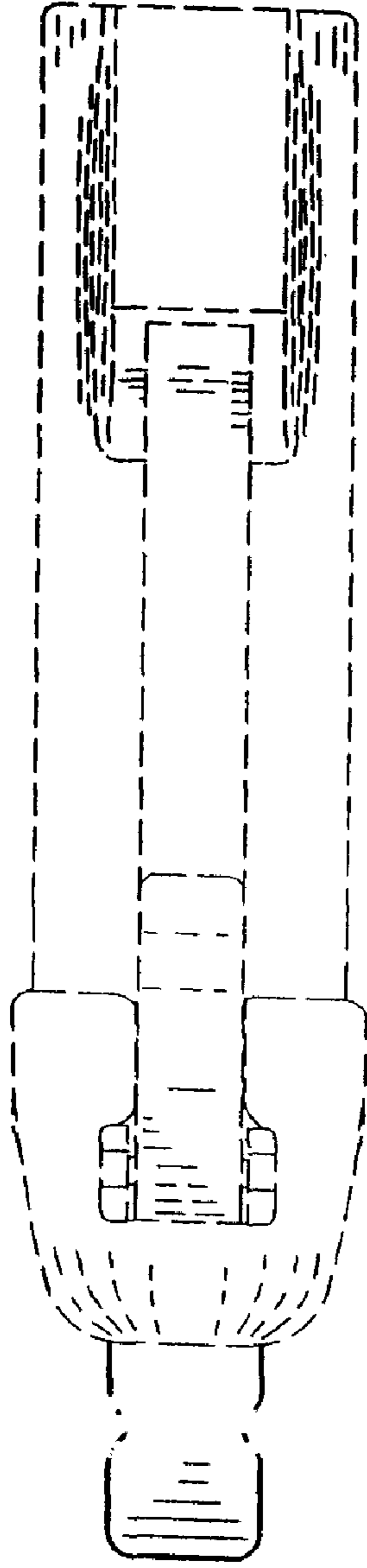
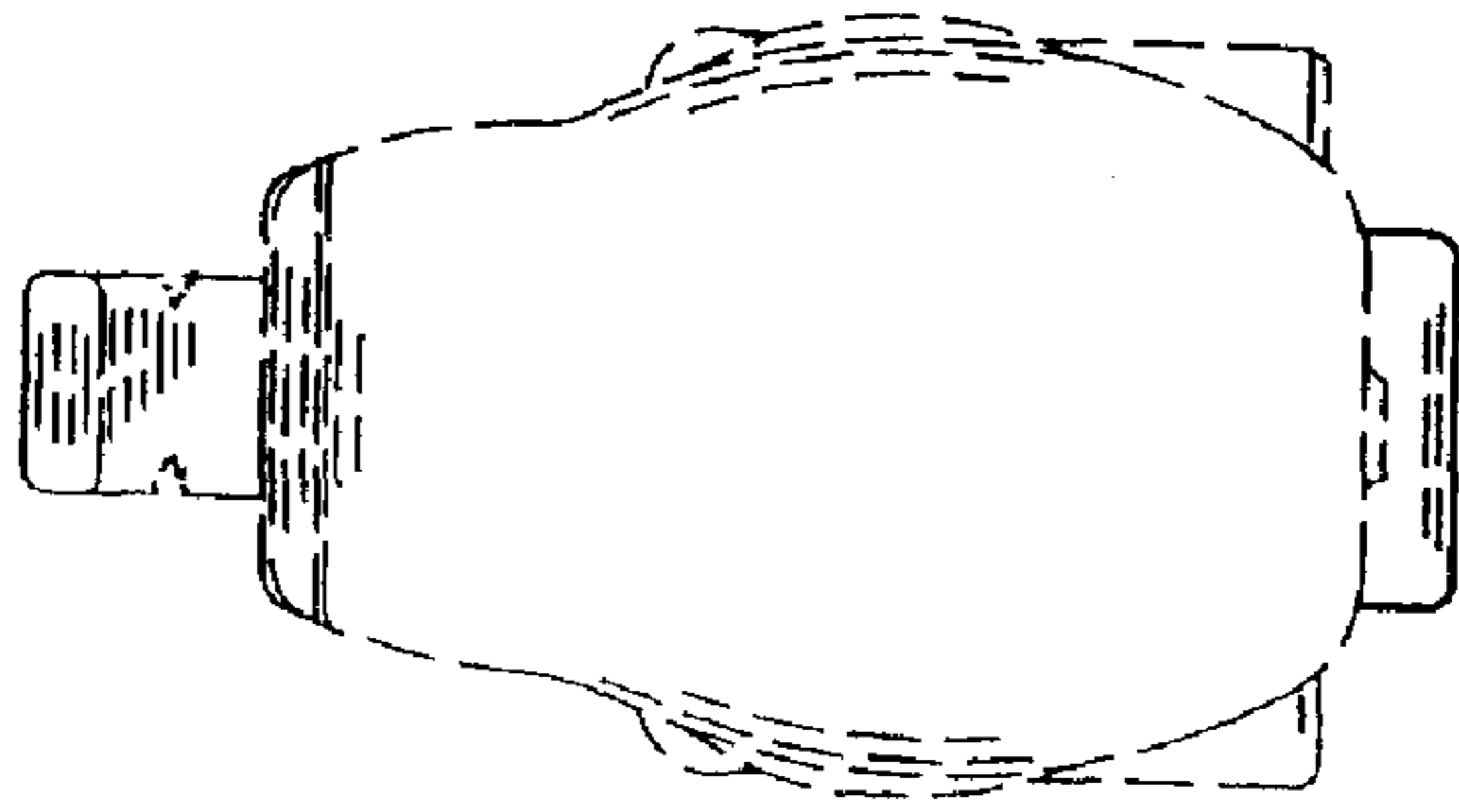

FIG. 4



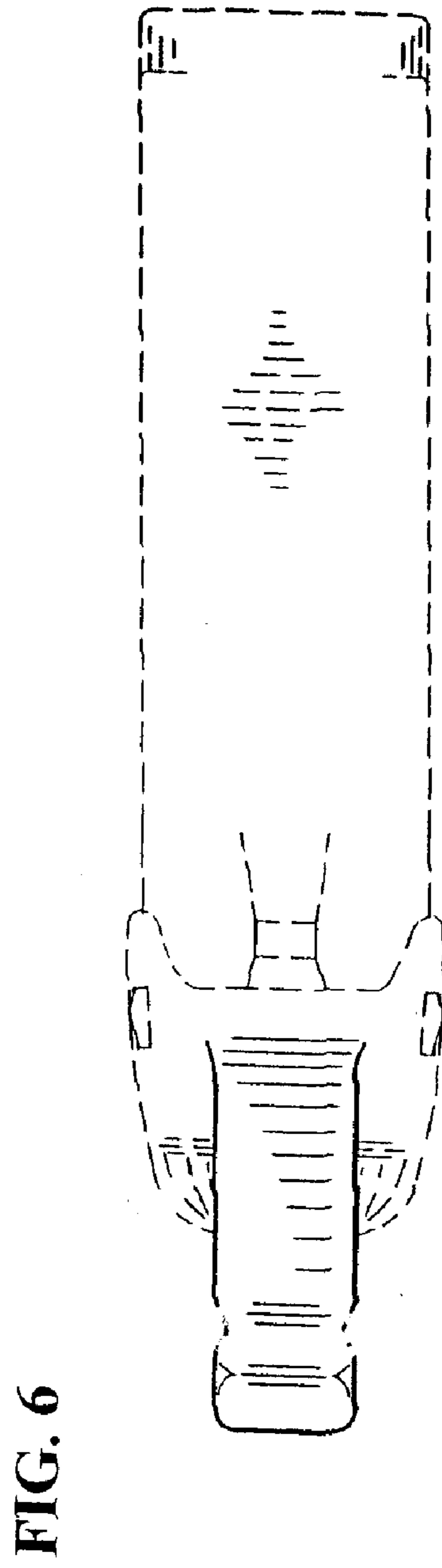
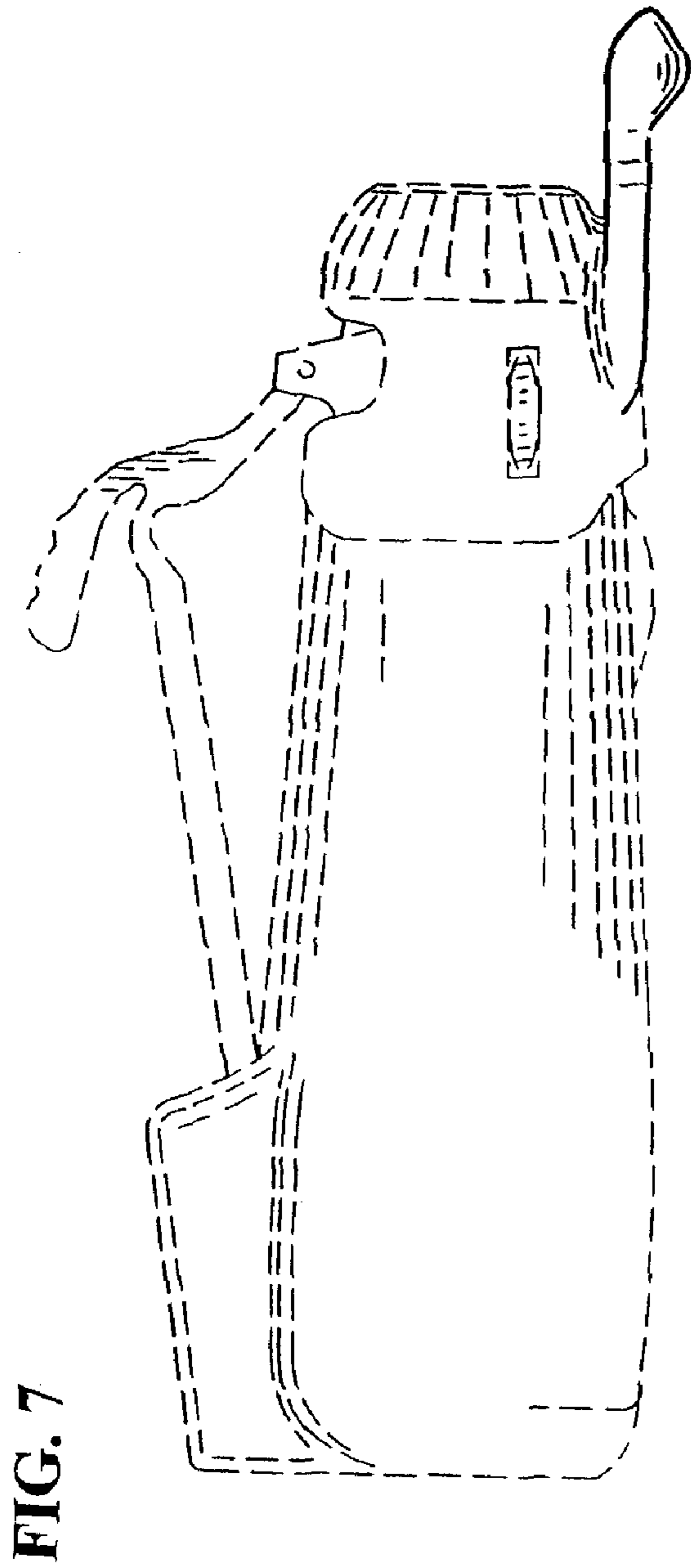

FIG. 8

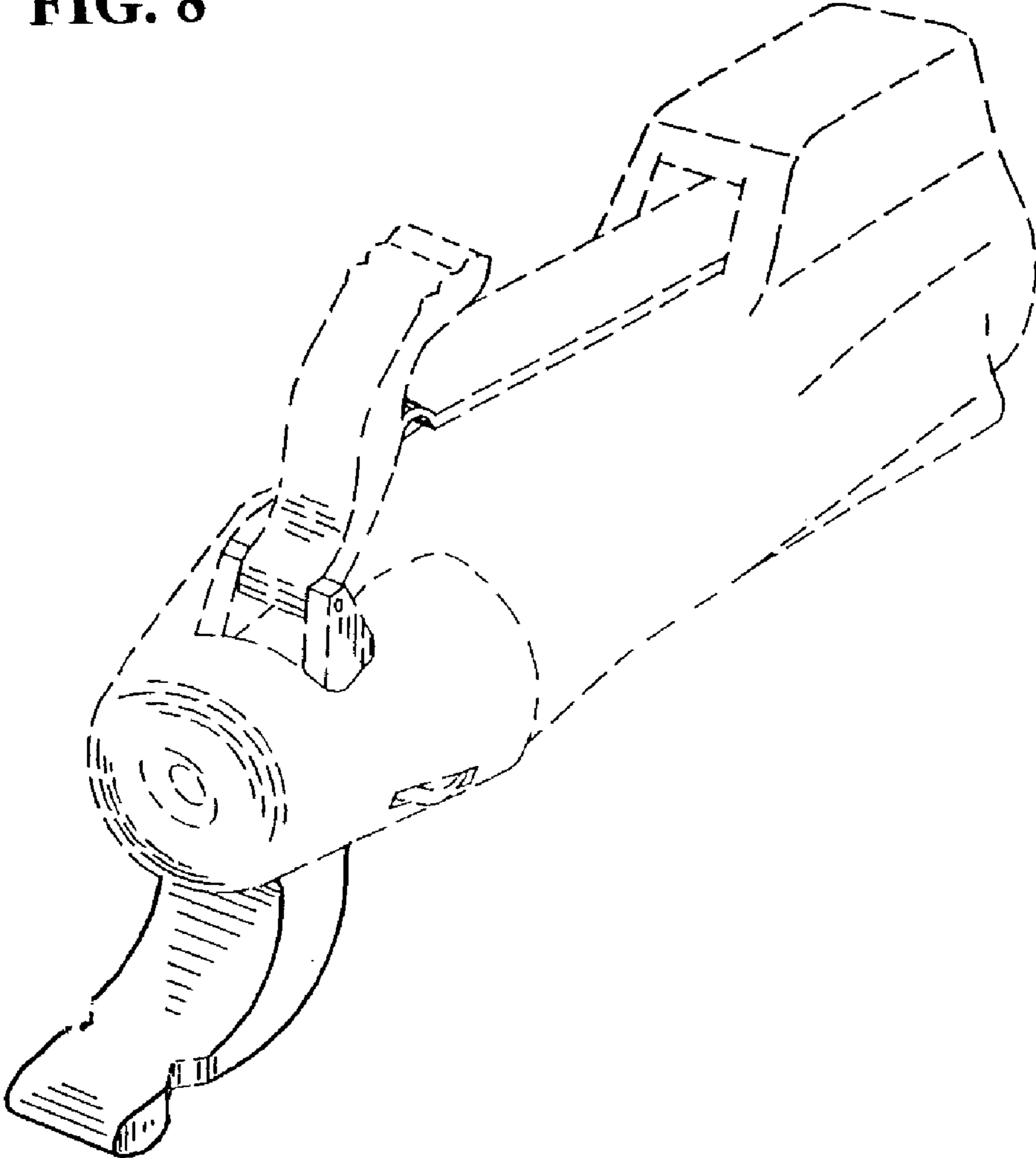

FIG. 9

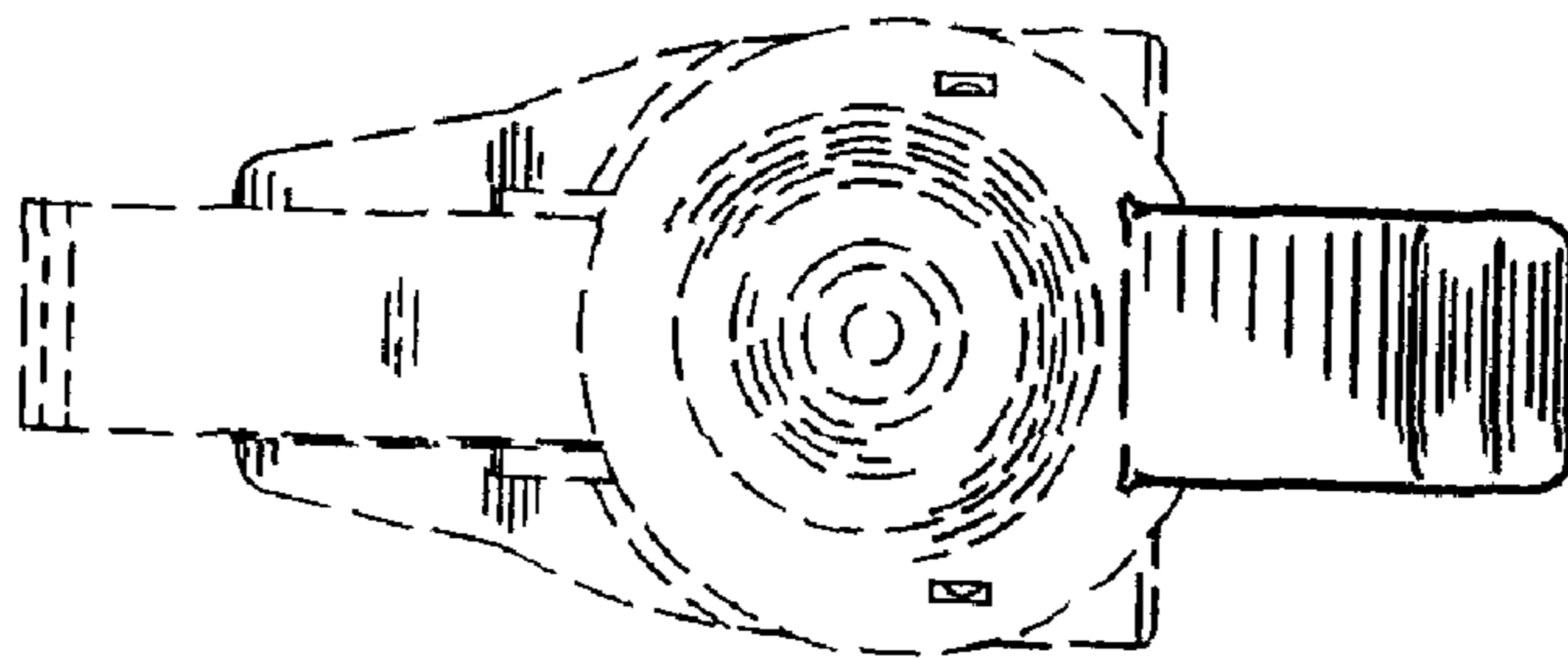

FIG. 10

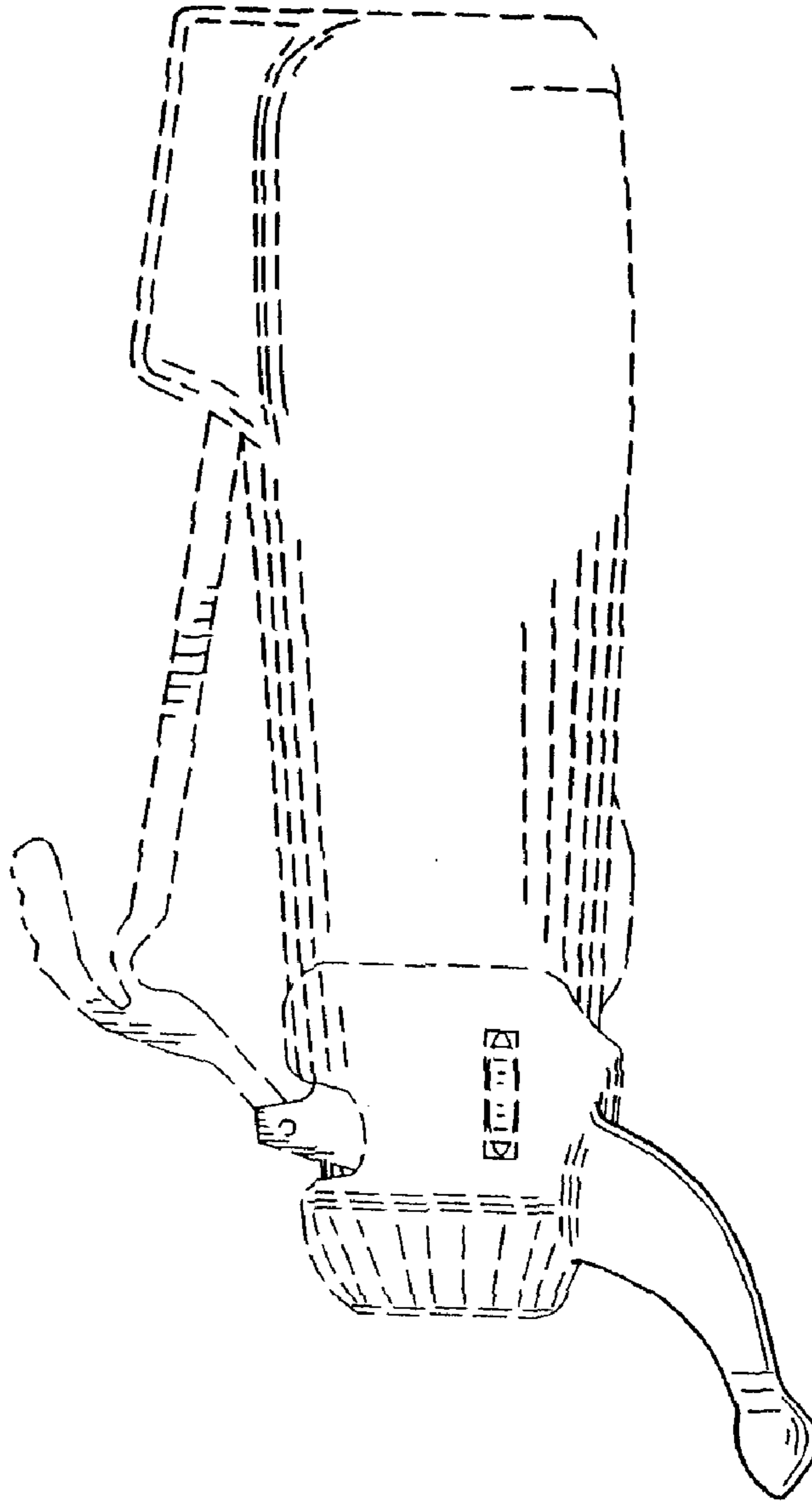

FIG. 12

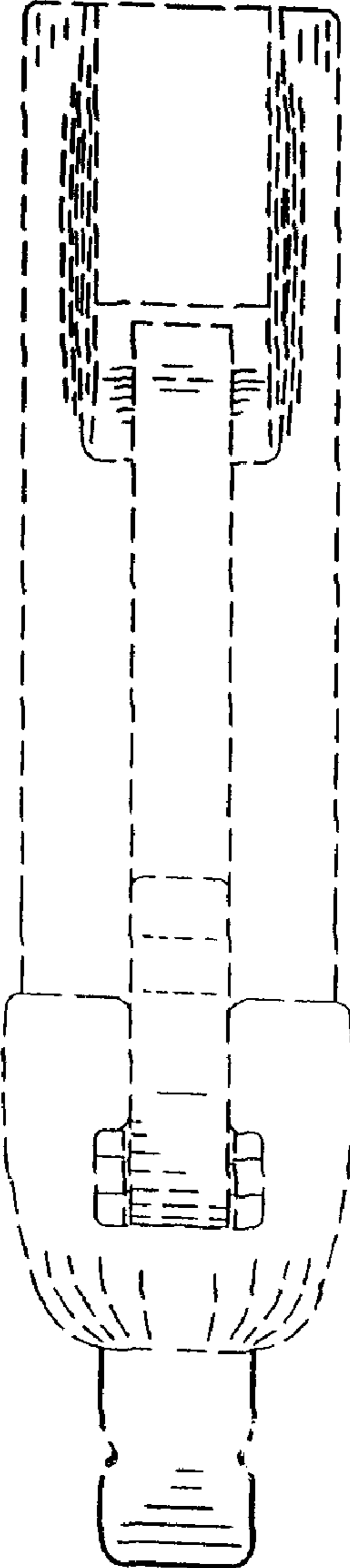

FIG. 11

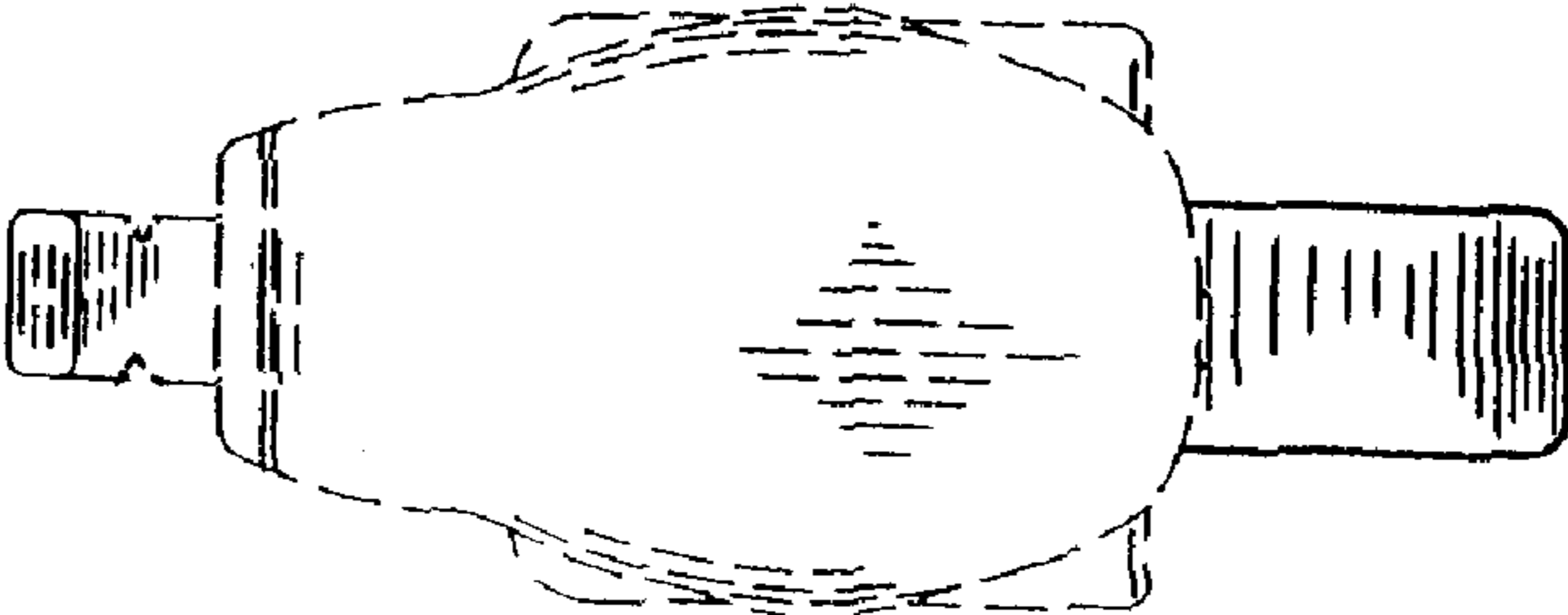

FIG. 14

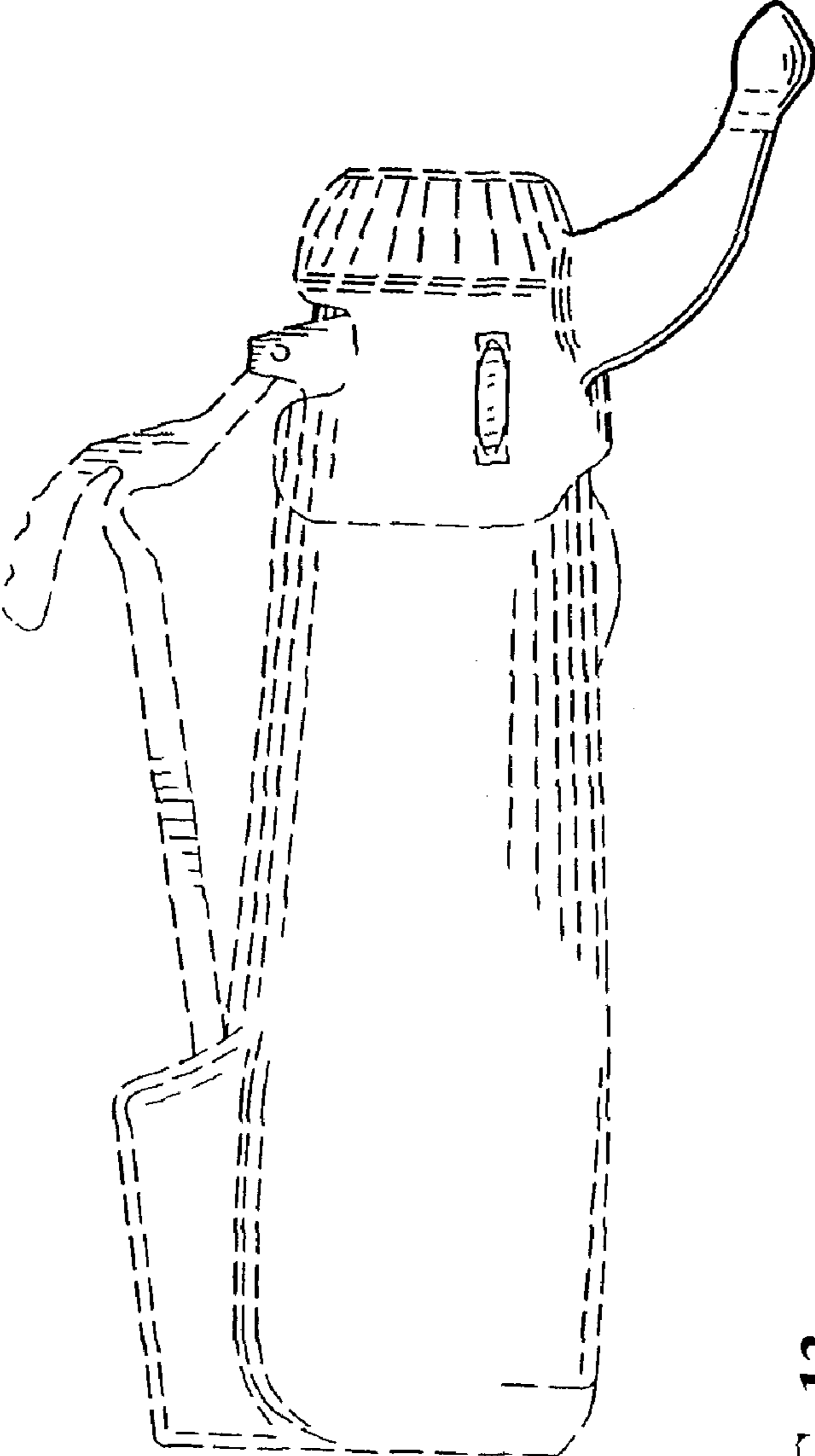

FIG. 13

